

THIS DOCUMENT IS SUBJECT TO CHANGE WITHOUT NOTICE. IT IS CONFIDENTIAL AND A PROPERTY OF Amphenol LTW. DISCLOSURE TO THIRD PARTY HAS TO BE AUTHORIZED BY Amphenol LTW.

REV.	ECN NO.	DATE	SIGN	DESCRIPTION

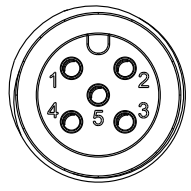

Conn. 1 & 3
Pin Assignments
Front View

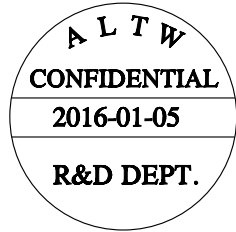
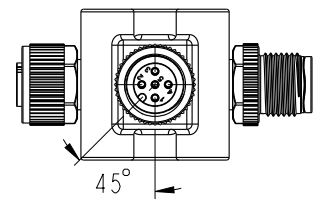
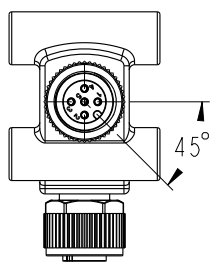
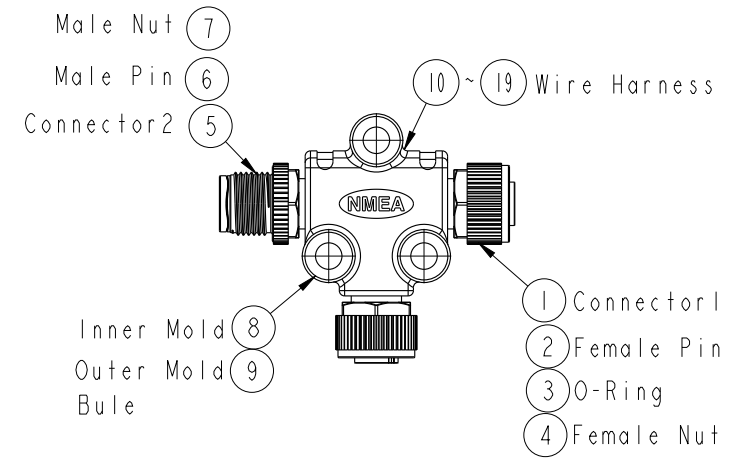
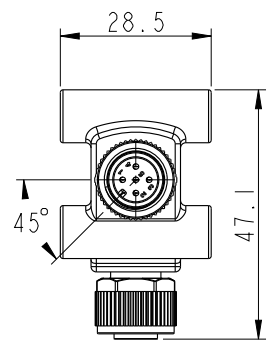
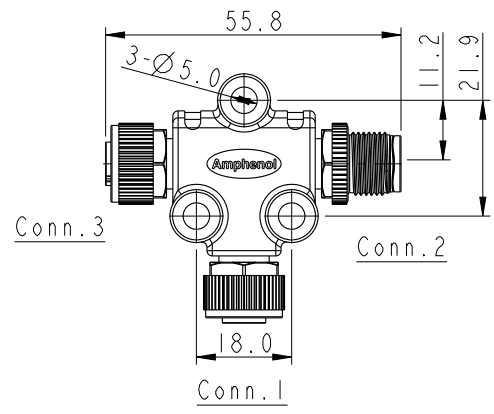
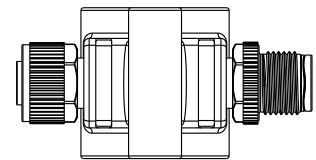
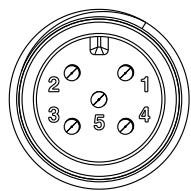

Conn. 2
Pin Assignments
Front View

Blue 藍	5	5	5
White 白	4	4	4
Black 黑	3	3	3
Red 紅	2	2	2
Green 綠	1	1	1
Wire Color	Conn. 1	Conn. 2	Conn. 3
	Pin Out		

Note:
 * (CC) Important Dimension To Check.
 * Waterproof Rate: IP68
 In 1 meter water within 24 hours
 * Connector: Pu, Black
 * Nut: PA66, Black
 * Pin: Copper Alloy, Gold Plated 30u"
 * Outer Mold: PU, Blue
 * Wire Harness: UL1061, 22AWG

UNIT: mm
 TOLERANCE ±0.50mm

TITLE NMEA2000 Micro-C T Adaptor			
SCALE 1:1	SIZE A4	SHEET 1 OF 1	
REV. A	WC-REV. A.1	CC: Inspection item	

Amphenol LTW
 安費諾亮泰企業股份有限公司

ITEM NO. HPC-050505-FMF-TS001	DRAWN BY Cary	DATE 2016-01-05
DWG NO. HPC-050505-FMF-TS001	CHECKED BY Yulong	DATE 2016-01-05
CUSTOMER ALTW	APPROVED BY Jerry	DATE 2016-01-05