

THIS DOCUMENT IS SUBJECT TO CHANGE WITHOUT NOTICE. IT IS CONFIDENTIAL AND A PROPERTY OF Amphenol LTW. DISCLOSURE TO THIRD PARTY HAS TO BE AUTHORIZED BY Amphenol LTW.

REV.	ECN NO.	DATE	SIGN	DESCRIPTION
B	E191899	2019/11/19	Ruru	$\triangle B$ X4

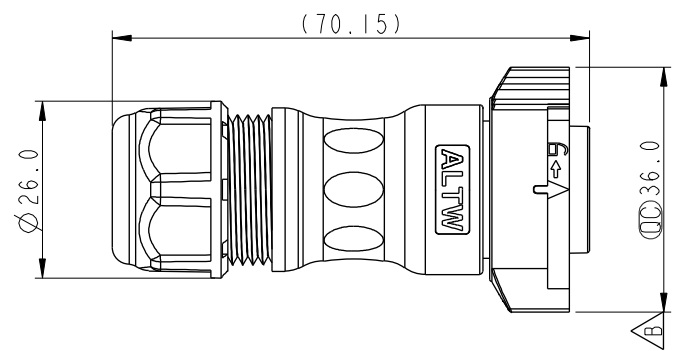
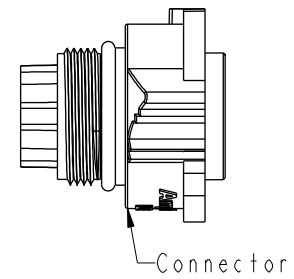
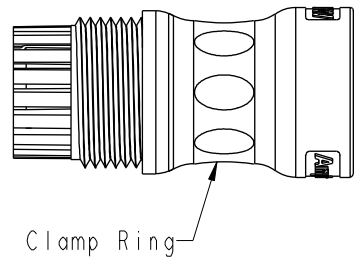
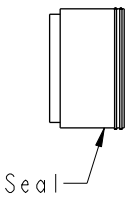
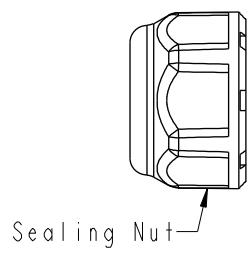

DD-XXBFMA-QL8XP0
 12-12 Pin
 14-14 Pin
 18-18 Pin

S: With Red Color Seal 1, Cable OD 6.0~8.0mm.
 M: With Yellow Color Seal 2, Cable OD 8.0~10.0mm.
 L: With Blue Color Seal 3, Cable OD 10.0~12.0mm.
 A: With Seal 1 & Seal 2 & Seal 3.

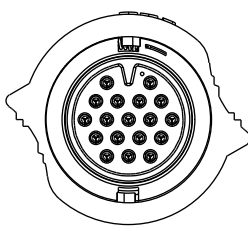
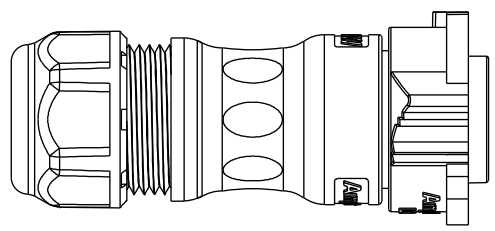

- $\triangle B$ Note:
- * CC Important Dimension
 - * Waterproof Rate: IP68, Mated
IP68 : 1M Depth Of Water In 24hours
 - * Housing: Thermoplastic, Black
 - * Pin: Copper Alloy, Gold Plated
 - * Clamp Ring: Thermoplastic, Black
 - * Sealing Nut: Thermoplastic, Black
 - * Seals: Rubber

Pin Assignments Front View	12 Pin	14 Pin	18 Pin

UNIT:mm TOLERANCE ± 0.5 mm	TITLE XLOK, D-5A, CABLE W/O SR F, M, FI CRIMP, XLOK $\triangle B$		<h1>Amphenol LTW</h1> <p>安費諾亮泰企業股份有限公司</p>		ITEM NO	DRAWN BY Ruru	DATE 2019-11-19		
	SCALE 1:1	SIZE A4			SHEET 1	OF 1	DWG NO DD-XXBFMA-QL8XP0 $\triangle B$	CHECKED BY Rita	DATE 2019-11-19
	REV. B	WC-REV. .0			CC : Inspection item		CUSTOMER ALTW	APPROVED BY Max	DATE 2019-11-19