

REV.	ECN NO.	DATE	SIGN	DESCRIPTION

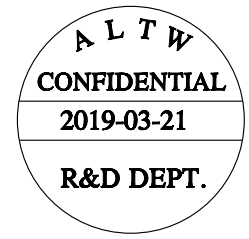
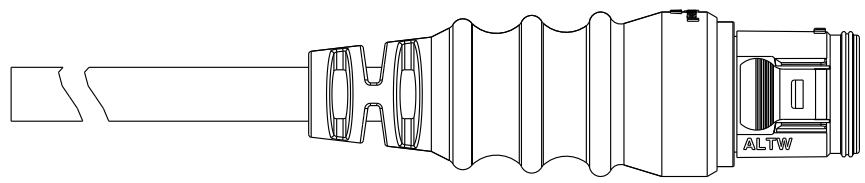
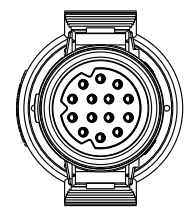
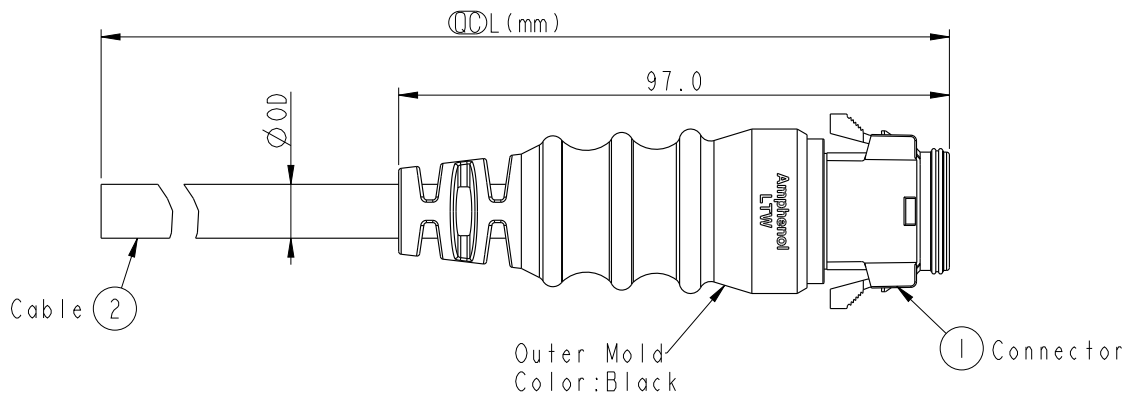

Note:

- * \varnothing Important Dimension
- * Waterproof Rate: IP68
- * Housing: M-PPE, Black
- * Female Pin: Copper Alloy, Gold Plated
- * Cable: UL21388 20#, PVC Jacket, Black.
- * Cable Length Tolerance: 01M:±40mm
02M~05M:±60mm
06M~10M:±100mm
11M~30M:±200mm
31M~99M:±500mm
- * Prohibiting the use of place in oils

DD-05AMFM-RL8DXX	Ø 6.2
DD-06AMFM-RL8DXX	Ø 6.8
DD-07AMFM-RL8DXX	
DD-08AMFM-RL8DXX	Ø 7.2
DD-09AMFM-RL8DXX	Ø 7.6
DD-10AMFM-RL8DXX	Ø 8.5
DD-12AMFM-RL8DXX	
DD-14AMFM-RL8DXX	
Part No.	Cable OD

UNIT: mm			TITLE LARGE CABLE RBL M CONN F PIN
TOLERANCE ±0.5	SCALE 3:4	SIZE A4	SHEET 1 OF 3
REV. A	WC-REV. A.1	\varnothing : Inspection item	

Amphenol LTW
安費諾亮泰企業股份有限公司

ITEM NO.	DRAWN BY Peng	DATE 2019-03-21
DWG NO. DD-XXAMFM-RL8DXX	CHECKED BY Mafei	DATE 2019-03-21
CUSTOMER ALTW	APPROVED BY Jerry	DATE 2019-03-21

THIS DOCUMENT IS SUBJECT TO CHANGE WITHOUT NOTICE. IT IS CONFIDENTIAL AND A PROPERTY OF Amphenol LTW. DISCLOSURE TO THIRD PARTY HAS TO BE AUTHORIZED BY Amphenol LTW.

THIS DOCUMENT IS SUBJECT TO CHANGE WITHOUT NOTICE. IT IS CONFIDENTIAL AND A PROPERTY OF Amphenol LTW. DISCLOSURE TO THIRD PARTY HAS TO BE AUTHORIZED BY Amphenol LTW.

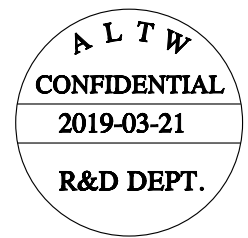

DD-XXAMFM-RL8D XX

Large Size Current Rating 5A

- XX: No. Of Pin (Pin 數)
- A: Cable With S/R (線端帶網尾)
- M: Male Connector (公座)
- F: Female Pin (母Pin)
- M: Molding Type (射出成型)



- XX: 01~99 Meter
- 01: 01 Meter
- 02: 02 Meter
- ...
- 99: 99 Meter
- D: UL21388 Cable
- 8: IP68 (防水等級 68)
- L: Straight (180°)
- R: Snap In With Latch (彈臂卡合)

Pin Out	9	Yellow (黃)	9	Green (綠)	9	Blue (藍)	9	Purple (紫)	9	Gray (灰)
	8	--	8	--	8	Green (綠)	8	--	8	Purple (紫)
	7	Orange (橘)	7	Yellow (黃)	7	Yellow (黃)	7	Blue (藍)	7	Blue (藍)
	6	--	6	--	6	--	6	Green (綠)	6	Green (綠)
	5	Red (紅)	5	Orange (橘)	5	Orange (橘)	5	Yellow (黃)	5	Yellow (黃)
	4	--	4	Red (紅)	4	Red (紅)	4	Orange (橘)	4	Orange (橘)
	3	Brown (棕)	3	Brown (棕)	3	Brown (棕)	3	Red (紅)	3	Red (紅)
	2	--	2	--	2	--	2	Brown (棕)	2	Brown (棕)
	1	Black (黑)	1	Black (黑)	1	Black (黑)	1	Black (黑)	1	Black (黑)
Pin Assignments Front View										
	5Pin		6Pin		7Pin		8Pin		9Pin	

UNIT: mm TOLERANCE ±0.5	TITLE LARGE CABLE RBL M CONN F PIN			<h1>Amphenol LTW</h1> <p>安費諾亮泰企業股份有限公司</p>	ITEM NO	DRAWN BY	DATE
	SCALE 3:4	SIZE A4	SHEET 2 OF 3		DWG NO DD-XXAMFM-RL8DXX	CHECKED BY Mafei	DATE 2019-03-21
	REV. A	WC-REV. A.1	☉: Inspection item		CUSTOMER ALTW	APPROVED BY Jerry	DATE 2019-03-21

THIS DOCUMENT IS SUBJECT TO CHANGE WITHOUT NOTICE. IT IS CONFIDENTIAL AND A PROPERTY OF Amphenol LTW. DISCLOSURE TO THIRD PARTY HAS TO BE AUTHORIZED BY Amphenol LTW.

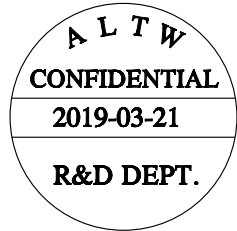
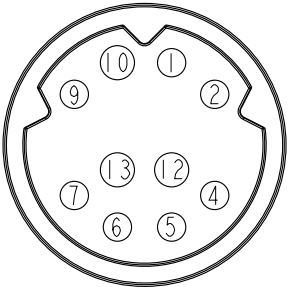
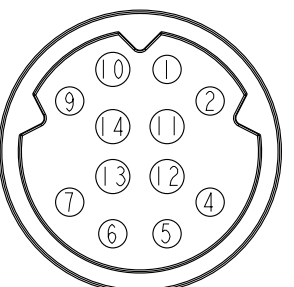
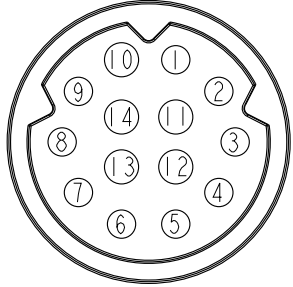
F														
E														
D														
C														
B														
A														

Pin Out	14	--	14	Light Green(淺綠)	14	Brown/White(棕/白)										
	13	White(白)	13	Pink(粉紅)	13	Black/White(黑/白)										
	12	Gray(灰)	12	White(白)	12	Light Green(淺綠)										
	11	--	11	Gray(灰)	11	Pink(粉紅)										
	10	Purple(紫)	10	Purple(紫)	10	White(白)										
	9	Blue(藍)	9	Blue(藍)	9	Gray(灰)										
	8	--	8	--	8	Purple(紫)										
	7	Green(綠)	7	Green(綠)	7	Blue(藍)										
	6	Yellow(黃)	6	Yellow(黃)	6	Green(綠)										
	5	Orange(橘)	5	Orange(橘)	5	Yellow(黃)										
	4	Red(紅)	4	Red(紅)	4	Orange(橘)										
	3	--	3	--	3	Red(紅)										
	2	Brown(棕)	2	Brown(棕)	2	Brown(棕)										
	1	Black(黑)	1	Black(黑)	1	Black(黑)										
Pin Assignments Front View	 10Pin				 12Pin				 14Pin							
UNIT:mm	 TOLERANCE ±0.5		TITLE LARGE CABLE RBL M CONN F PIN				Amphenol LTW 安費諾亮泰企業股份有限公司				ITEM NO	DRAWN BY	DATE			
			SCALE 3:4	SIZE A4	SHEET 3	OF 3	DD-XXAMFM-RL8DXX				CHECKED BY	DATE				
			REV. A	WC-REV. A.1	 : Inspection item		ALTW				APPROVED BY	DATE				
							Jerry				DATE	2019-03-21				