

THIS DOCUMENT IS SUBJECT TO CHANGE WITHOUT NOTICE. IT IS CONFIDENTIAL AND A PROPERTY OF Amphenol LTW. DISCLOSURE TO THIRD PARTY HAS TO BE AUTHORIZED BY Amphenol LTW.

REV.	ECN NO.	DATE	SIGN	DESCRIPTION
B	C191866	2019/10/15	Ouyang	△B X5
C	C220487	2022/04/01	Vicky	△C X4

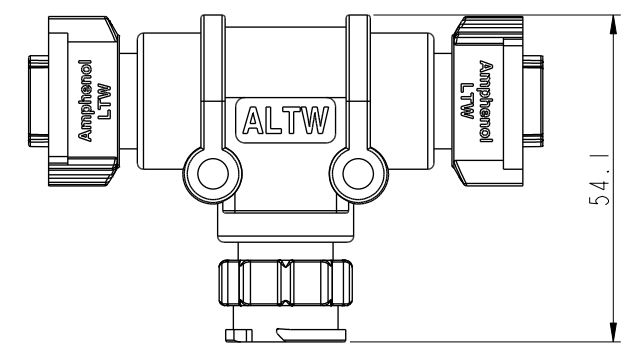
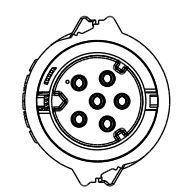
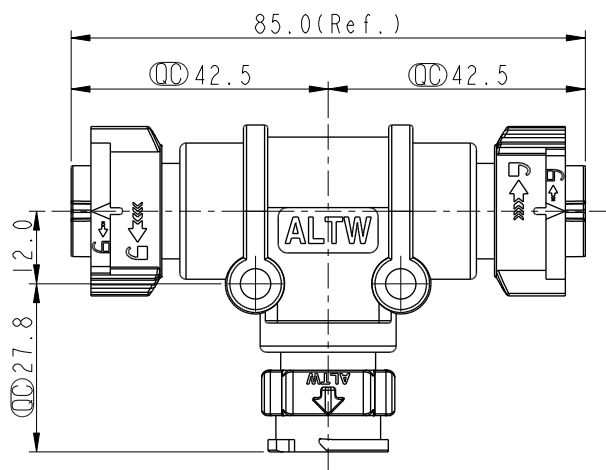

△B Conn. 2  
Female Conn  
Female Pin

△B Conn. 3  
Female Conn  
Female Pin

△B Conn. 1  
Male Conn  
Male Pin

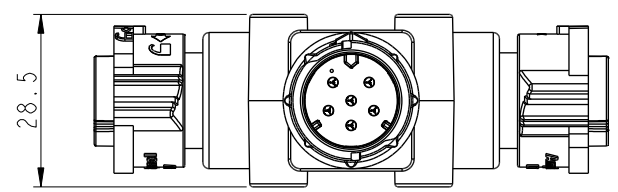

- △C Note:
- \* RoHS Compliant
  - \* ⌀ Important dimension
  - \* C1  
Waterproof rate: IPX8, mated 1m/24h  
Housing: Thermoplastic, Black  
Pin: Copper alloy, Gold plated
  - \* C2 & C3  
Waterproof rate: IPX8, mated 1m/24h  
Housing: Thermoplastic, Black  
Pin: Copper alloy, Gold plated  
O-Ring: Rubber, Gray  
Nut: Thermoplastic, Black
  - \* Wire: UL1007, 16AWG
  - \* Outer Mold: Thermoplastic, Black

UNIT: mm

TOLERANCE  
±0.5mm

TITLE ACC, XLOK, C-10A, T ADA W/O CB MFF			△C
SCALE 1:1	SIZE A4	SHEET 1 OF 2	
REV. C	WC-REV. .0	⌀: Inspection item	

**Amphenol LTW**  
安費諾亮泰企業股份有限公司

ITEM NO AB-CB-XXXXXX-MFF-TQ001	DRAWN BY Ouyang	DATE 2019-07-30
CUSTOMER ALTW	CHECKED BY Jerry	DATE 2019-07-30
	APPROVED BY Fred	DATE 2019-07-30

THIS DOCUMENT IS SUBJECT TO CHANGE WITHOUT NOTICE. IT IS CONFIDENTIAL AND A PROPERTY OF Amphenol LTW. DISCLOSURE TO THIRD PARTY HAS TO BE AUTHORIZED BY Amphenol LTW.

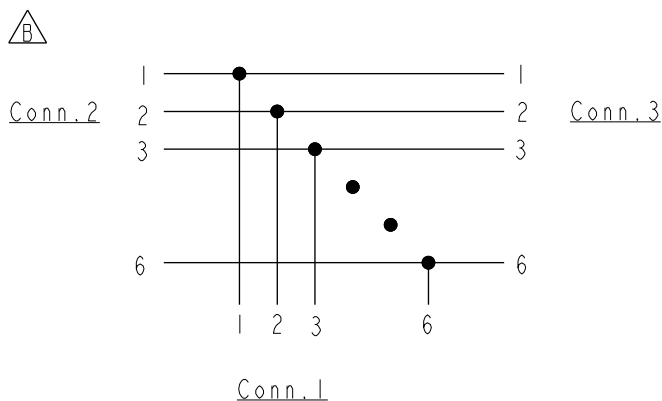

AB-CB-XXXXXX-MFF-TQ001

  
XXXXXX: No. Of Pin

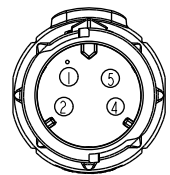
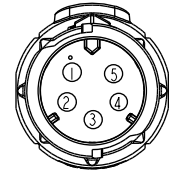
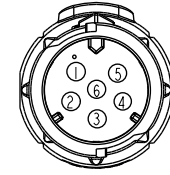
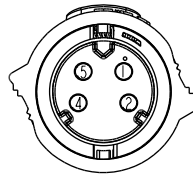
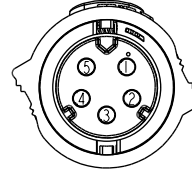
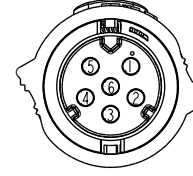

Connection Diagram

	Pin Assignments Front View					
	4PIN		5PIN		6PIN	
MALE						
Female						
Pin Out	Pin#	Color	Pin#	Color	Pin#	Color
	Pin1	Black(黑)	Pin1	Black(黑)	Pin1	Black(黑)
	Pin2	Brown(棕)	Pin2	Brown(棕)	Pin2	Brown(棕)
	Pin4	Orange(橙)	Pin3	Red(紅)	Pin3	Red(紅)
	Pin5	Yellow(黃)	Pin4	Orange(橙)	Pin4	Orange(橙)
			Pin5	Yellow(黃)	Pin5	Yellow(黃)
				Pin6	Green(綠)	

UNIT:mm			TITLE ACC, XLOK, C-10A, T ADA W/O CB MFF
TOLERANCE ±0.5mm	SCALE 1:1	SIZE A4	SHEET 2 OF 2
	REV. C	WC-REV. .0	 : Inspection item

**Amphenol LTW**  
安費諾亮泰企業股份有限公司

ITEM NO	DRAWN BY Ouyang	DATE 2019-07-30
DWG NO AB-CB-XXXXXX-MFF-TQ001	CHECKED BY Jerry	DATE 2019-07-30
CUSTOMER ALTW	APPROVED BY Fred	DATE 2019-07-30