

## P-channel Enhancement Mode Power MOSFET

### Features

- $V_{DS} = -20V$ ,  $I_D = -13A$   
 $R_{DS(ON)} < 17\ m\Omega$  @  $V_{GS} = -4.5V$   
 $R_{DS(ON)} < 20\ m\Omega$  @  $V_{GS} = -2.5V$

### General Features

- Advanced Trench Technology
- Provide Excellent  $R_{DS(ON)}$  and Low Gate Charge
- Lead Free and Green Available

100% UIS TESTED!

100%  $\Delta V_{ds}$  TESTED!

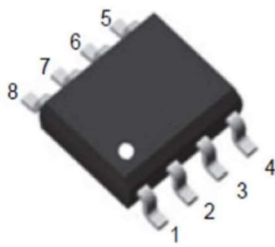

SOP-8

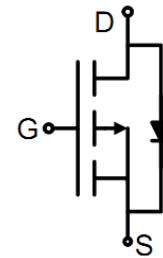
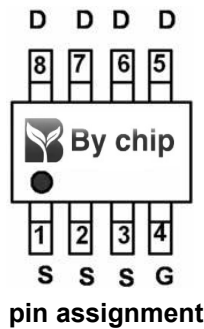

Schematic diagram

### ■ Absolute Maximum Ratings ( $T_A = 25^\circ C$ unless otherwise noted)

Parameter	Symbol	Maximum	Unit
Drain-source Voltage	$V_{DS}$	-20	V
Gate-source Voltage	$V_{GS}$	$\pm 10$	V
Drain Current	$I_D$	$T_A = 25^\circ C$ @ Steady State	-13
		$T_A = 70^\circ C$ @ Steady State	-10.4
Pulsed Drain Current <sup>A</sup>	$I_{DM}$	-55	A
Total Power Dissipation @ $T_A = 25^\circ C$	$P_D$	3.0	W
Thermal Resistance Junction-to-Ambient @ Steady State <sup>B</sup>	$R_{\theta JA}$	42	$^\circ C / W$
Junction and Storage Temperature Range	$T_J, T_{STG}$	-55 ~ +150	$^\circ C$

**■ Electrical Characteristics (T<sub>J</sub>=25°C unless otherwise noted)**

Parameter	Symbol	Conditions	Min	Typ	Max	Units
<b>Static Parameter</b>						
Drain-Source Breakdown Voltage	BV <sub>DSS</sub>	V <sub>GS</sub> = 0V, I <sub>D</sub> =-250μA	-20			V
Zero Gate Voltage Drain Current	I <sub>DSS</sub>	V <sub>DS</sub> =-20V, V <sub>GS</sub> =0V, T <sub>C</sub> =25°C			-1	μA
Gate-Body Leakage Current	I <sub>GSS</sub>	V <sub>GS</sub> = ±10V, V <sub>DS</sub> =0V			±100	nA
Gate Threshold Voltage	V <sub>GS(th)</sub>	V <sub>DS</sub> = V <sub>GS</sub> , I <sub>D</sub> =-250μA	-0.4		-2.0	V
Static Drain-Source On-Resistance	R <sub>DS(ON)</sub>	V <sub>GS</sub> = -4.5V, I <sub>D</sub> =-10A			17	mΩ
		V <sub>GS</sub> = -2.5V, I <sub>D</sub> =-6.5A			20	
		V <sub>GS</sub> = -1.8V, I <sub>D</sub> =-4.0A			26	
Diode Forward Voltage	V <sub>SD</sub>	I <sub>S</sub> =-13A, V <sub>GS</sub> =0V			-1.2	V
Maximum Body-Diode Continuous Current	I <sub>S</sub>				-13	A
<b>Dynamic Parameters</b>						
Input Capacitance	C <sub>iss</sub>	V <sub>DS</sub> =-10V, V <sub>GS</sub> =0V, f=1MHZ		2992		pF
Output Capacitance	C <sub>oss</sub>			330		
Reverse Transfer Capacitance	C <sub>rss</sub>			272		
<b>Switching Parameters</b>						
Total Gate Charge	Q <sub>g</sub>	V <sub>GS</sub> =-10V, V <sub>DS</sub> =-15V, I <sub>D</sub> =-9.1A		72.8		nC
Gate Source Charge	Q <sub>gs</sub>			6.6		
Gate Drain Charge	Q <sub>gd</sub>			10.1		
Reverse Recovery Charge	Q <sub>rr</sub>	I <sub>F</sub> =-6A, di/dt=100A/us		34		
Reverse Recovery Time	t <sub>rr</sub>			67		
Turn-on Delay Time	t <sub>D(on)</sub>	V <sub>GS</sub> =-10V, V <sub>DS</sub> =-15V, I <sub>D</sub> =-6A, R <sub>GEN</sub> =2.5Ω		7		ns
Turn-on Rise Time	t <sub>r</sub>			33		
Turn-off Delay Time	t <sub>D(off)</sub>			130		
Turn-off Fall Time	t <sub>f</sub>			132		

A. Pulse Test: Pulse Width ≤ 300us, Duty cycle ≤ 2%.

B. R<sub>θJA</sub> is the sum of the junction-to-lead and lead-to-ambient thermal resistance, where the lead thermal reference is defined as the solder mounting surface of the drain pins. R<sub>θJL</sub> is guaranteed by design, while R<sub>θJA</sub> is determined by the board design. The maximum rating presented here is based on mounting on a 1 in 2 pad of 2oz copper.

■ Typical Performance Characteristics

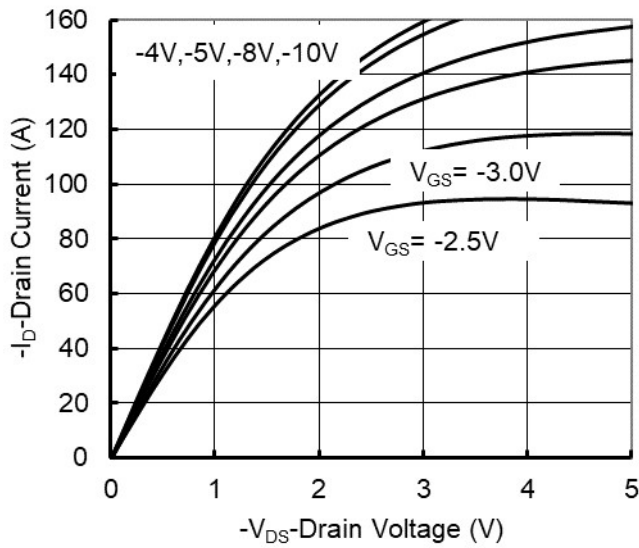

Figure 1. Output Characteristics

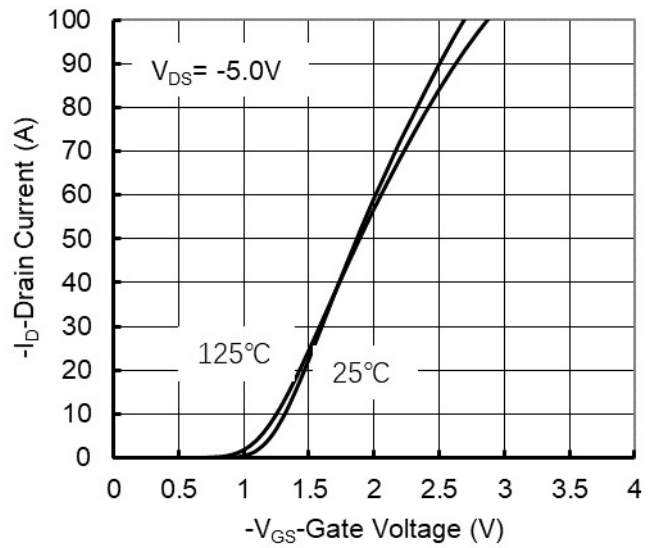

Figure 2. Transfer Characteristics

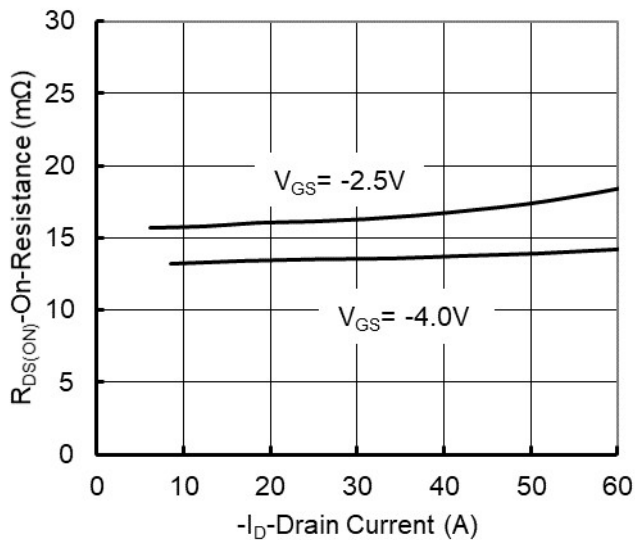

Figure 3. On-Resistance vs. Drain Current and Gate Voltage

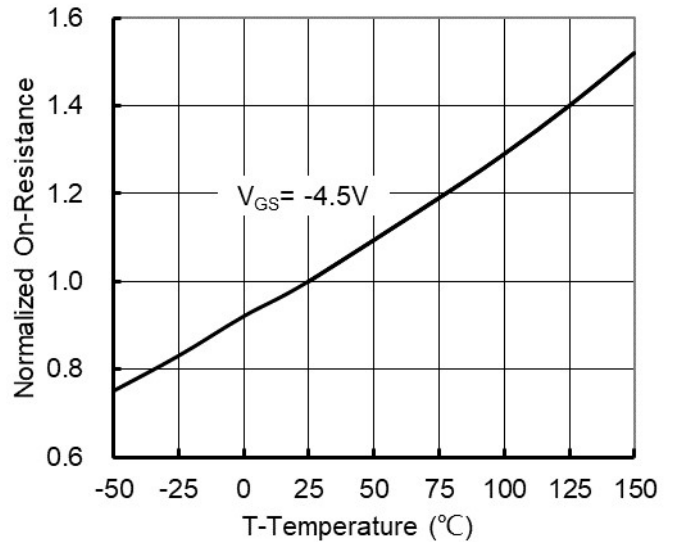

Figure 4. On-Resistance vs. Junction Temperature

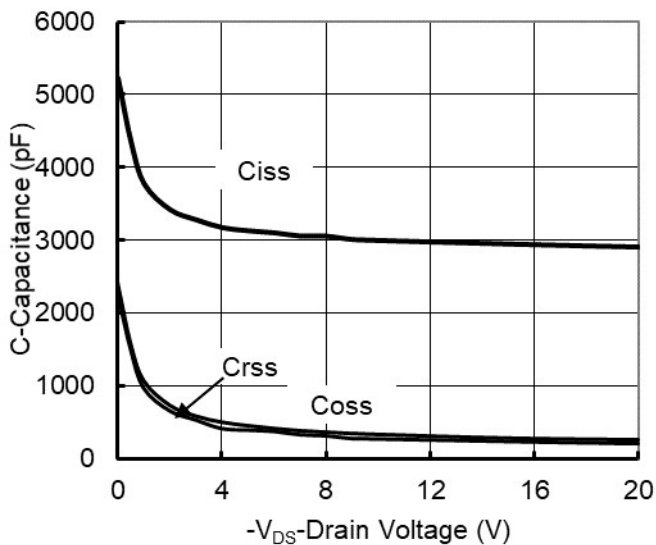

Figure 5. Capacitance Characteristics

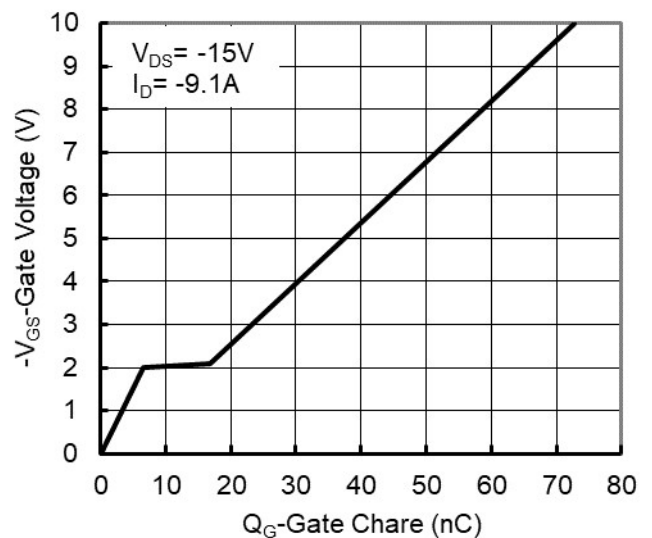

Figure 6. Gate Charge

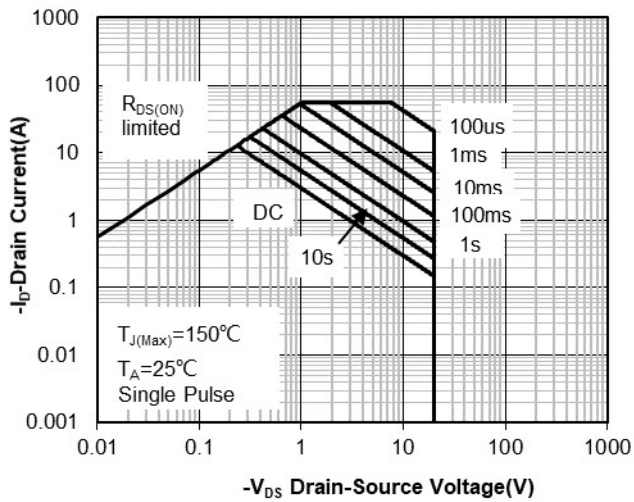

Figure 7. Safe Operation Area

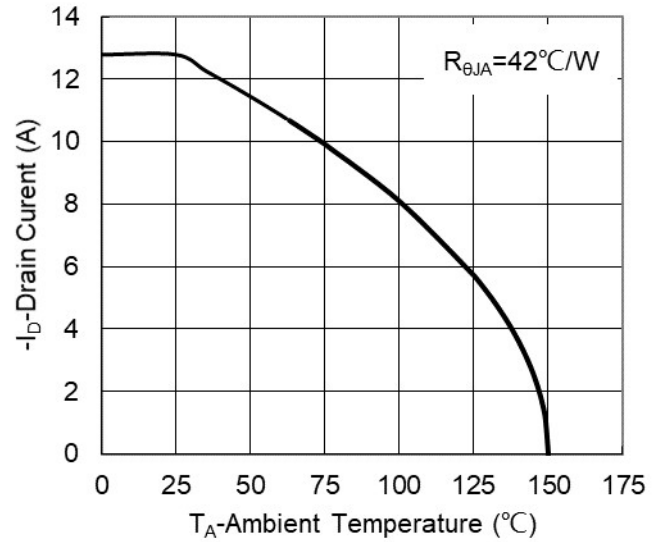

Figure 8. Maximum Continuous Drain Current vs Ambient Temperature

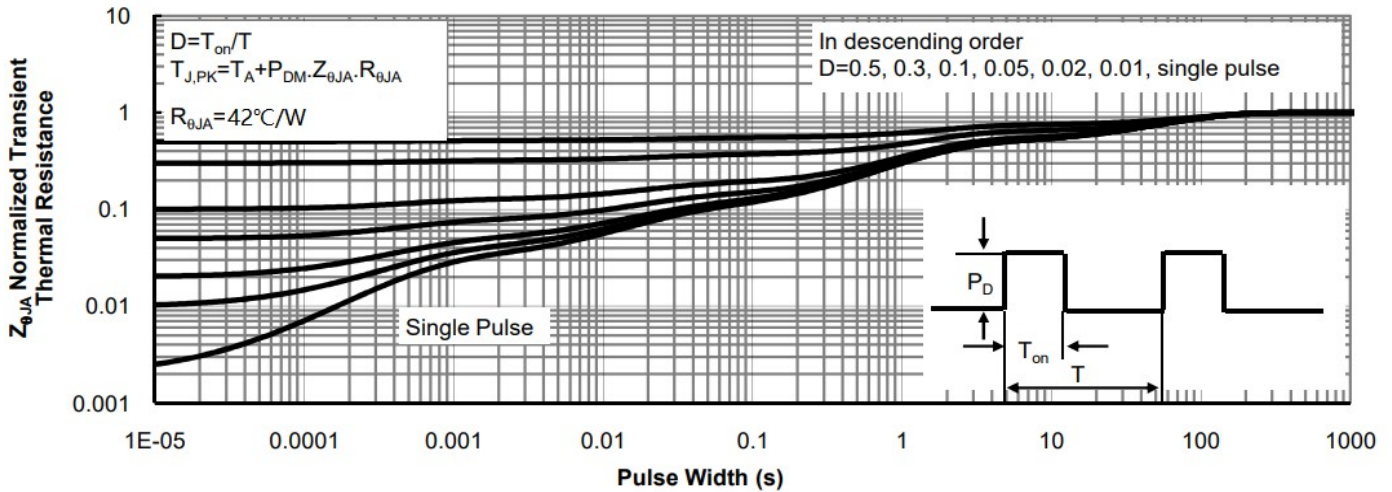
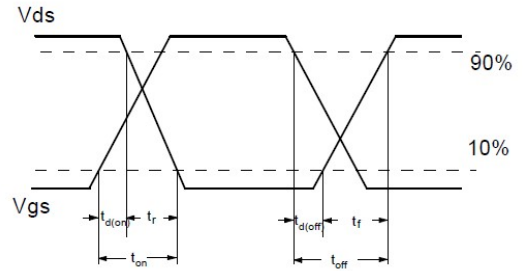
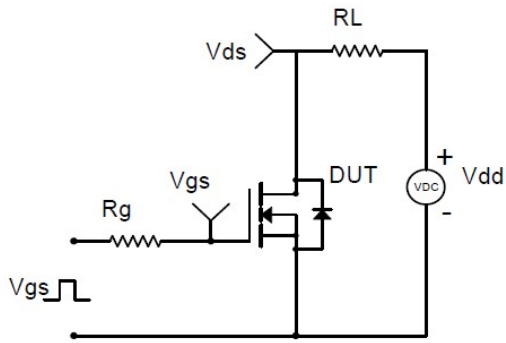
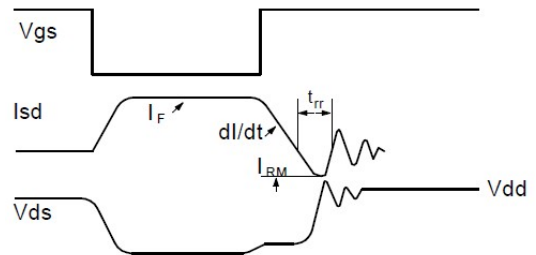
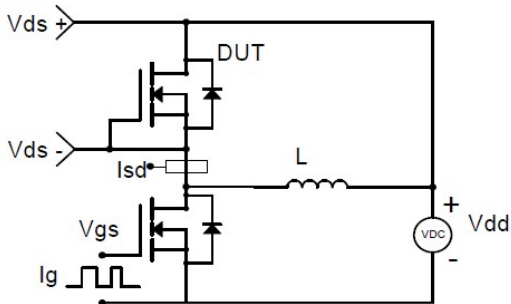

Figure 9. Normalized Maximum Transient Thermal Impedance



**Resistive Switching Test Circuit & Waveforms**



**Diode Recovery Test Circuit & Waveforms**



**Gate Charge Test Circuit & Waveform**

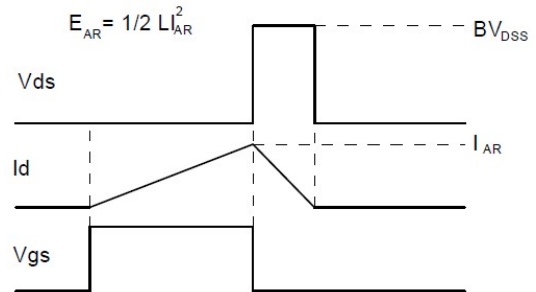
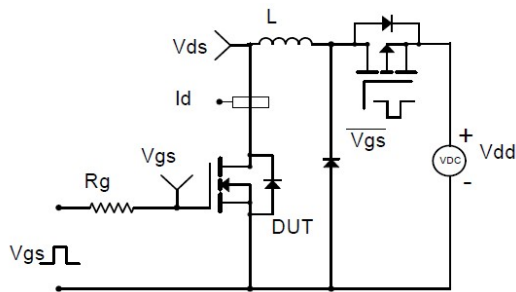

**Unclamped Inductive Switching (UIS) Test Circuit & Waveforms**