

REV.	ECN NO.	LOCATION	DESCRIPTION	DATE	DESIGN
1			INITIAL RELEASE	2018.09.28	Alex_Z

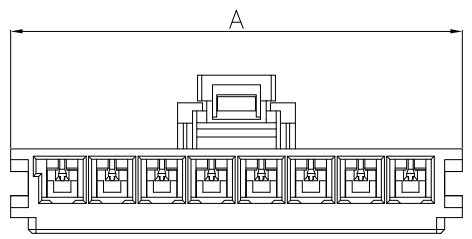
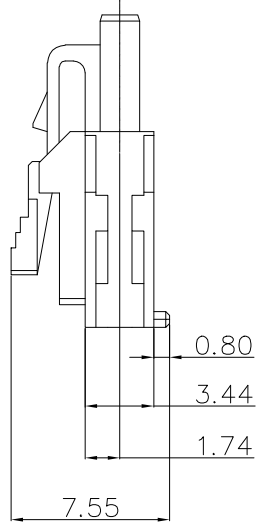
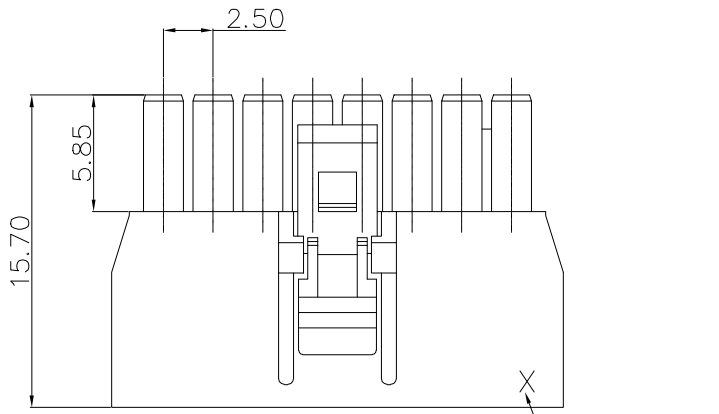

NOTES:  
 PRODUCT MEETS CONTROLLED SUBSTANCES SPEC.  
 1. MATERIAL:  
 1.1 HOUSING: PA4T,94V-0,BLACK.  
 2. THE COMPONENT COMPLIANT TO ROHS DIRECTIVE 2011/65/EU AND ELV DIRECTIVE 2000/53/EC

5704BG-004R1\*\*B\*\*

B: ACQUIESCENT  
 PIN NO.:  
 02: 2PIN  
 .....  
 08: 8PIN  
 COLOR:  
 0: BLACK  
 1: NATURAL  
 R:RoHS  
 H:HALOGEN-FREE  
 WTB

DIM.A	PIN NO.
7.70	2
10.20	3
12.70	4
15.20	5
17.70	6
20.20	7
22.70	8

DIM	TOL	DIM	TOL
x.	±0.35	x.	±2'
.x			
.xx	±0.25		

 <b>DEREN</b> SHENZHEN DEREN ELECTRONIC CO.,LTD		CUSTOMER DRAWING		DATE	TITLE: RECEPTACLE OF NANO-FIT S/R TAP VERTICAL CONSP POWER CONNECTOR
		DESIGN: Alex_Z	2018.09.28	P/N: SEE TABLE	
DRAW NO. ***		CHECK:		SHEET: 1/3	
REV. 1	APPROVAL:			SCALE: N/A	UNIT: mm

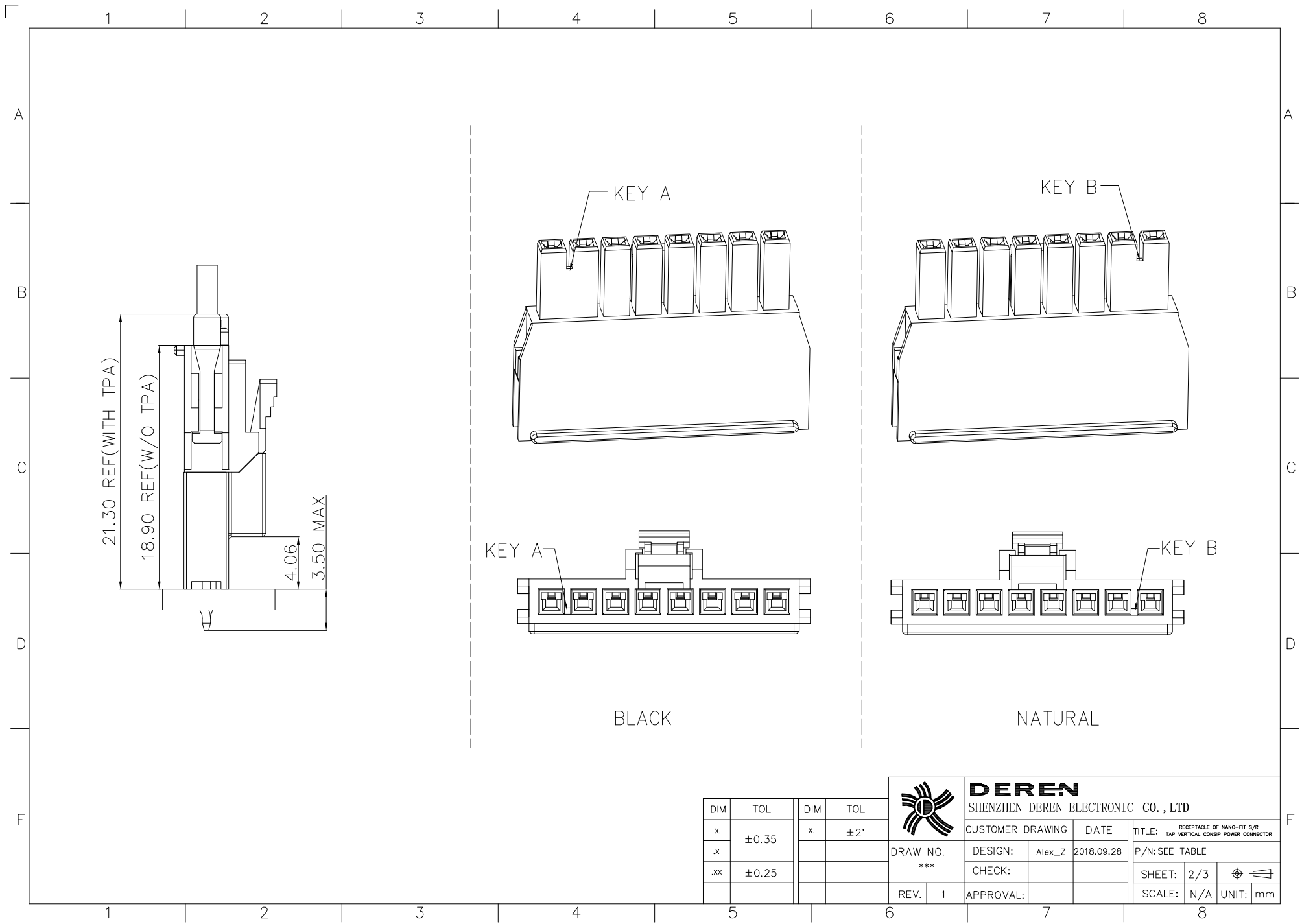

BLACK

NATURAL

DIM	TOL	DIM	TOL
.x	±0.35	.x	±2'
.x			
.xx	±0.25		

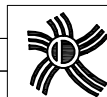

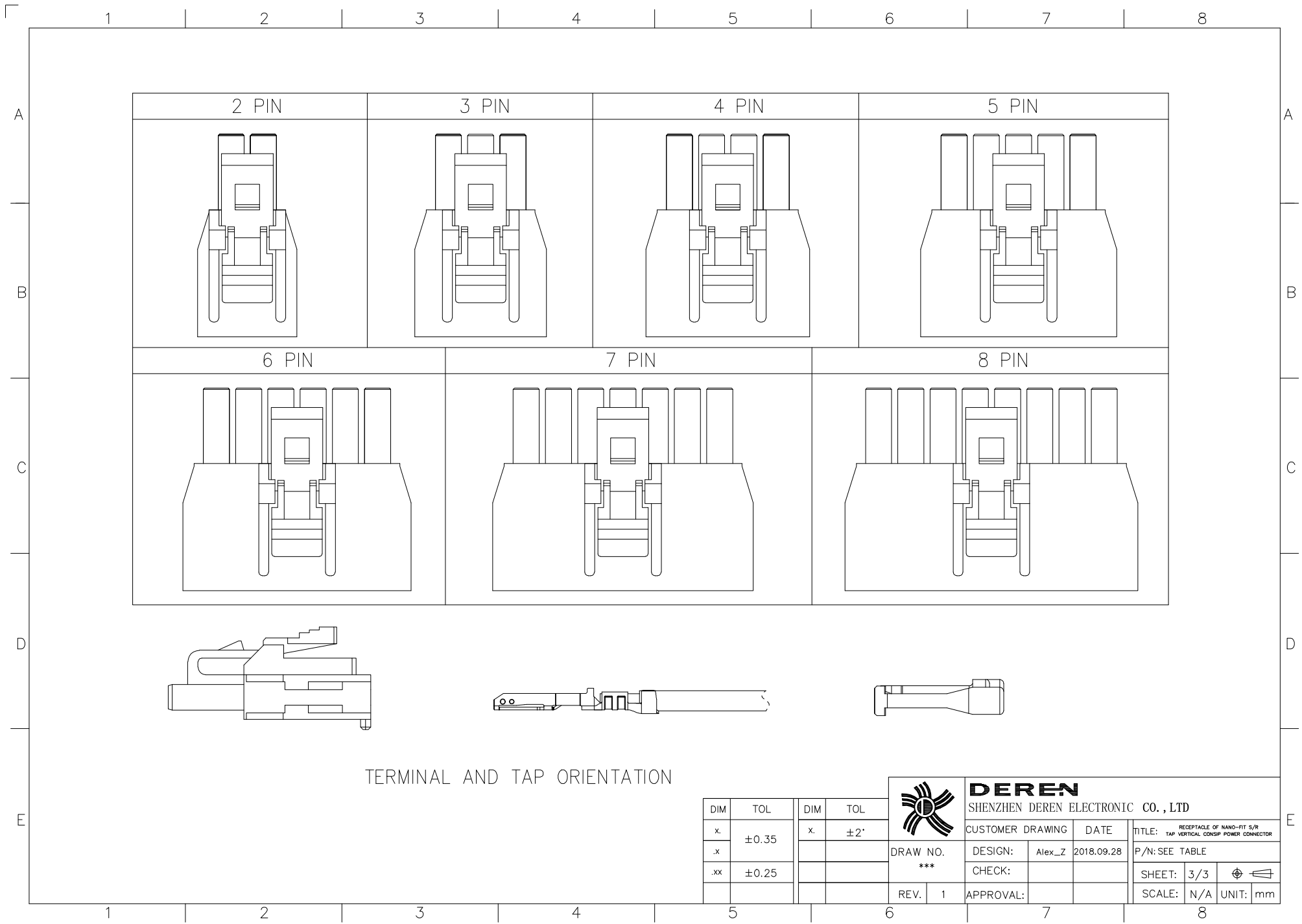

**DEREN**  
SHENZHEN DEREN ELECTRONIC CO., LTD

DRAW NO. ***	DESIGN:	Alex_Z	DATE	2018.09.28	TITLE: RECEPTACLE OF NANO-FIT S/R TAP VERTICAL CONSP POWER CONNECTOR	
	CHECK:				P/N: SEE TABLE	
REV.	1	APPROVAL:			SHEET: 2/3	
					SCALE: N/A	UNIT: mm



TERMINAL AND TAP ORIENTATION

DIM	TOL	DIM	TOL
x.	±0.35	x.	±2'
.x			
.xx	±0.25		

		<b>DEREN</b> SHENZHEN DEREN ELECTRONIC CO., LTD		CUSTOMER DRAWING		DATE	TITLE: RECEPTACLE OF NANO-FIT S/R TAP VERTICAL CONSP POWER CONNECTOR	
				DESIGN: Alex_Z	2018.09.28	P/N: SEE TABLE		
DRAW NO. ***		CHECK:		SHEET: 3/3				
REV. 1		APPROVAL:		SCALE: N/A		UNIT: mm		