

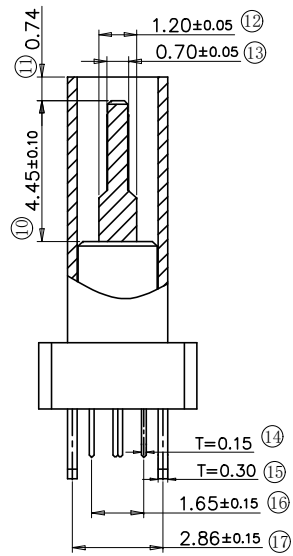

REV.	ECN NO OR DESCRIPTION	REVISED	DATE

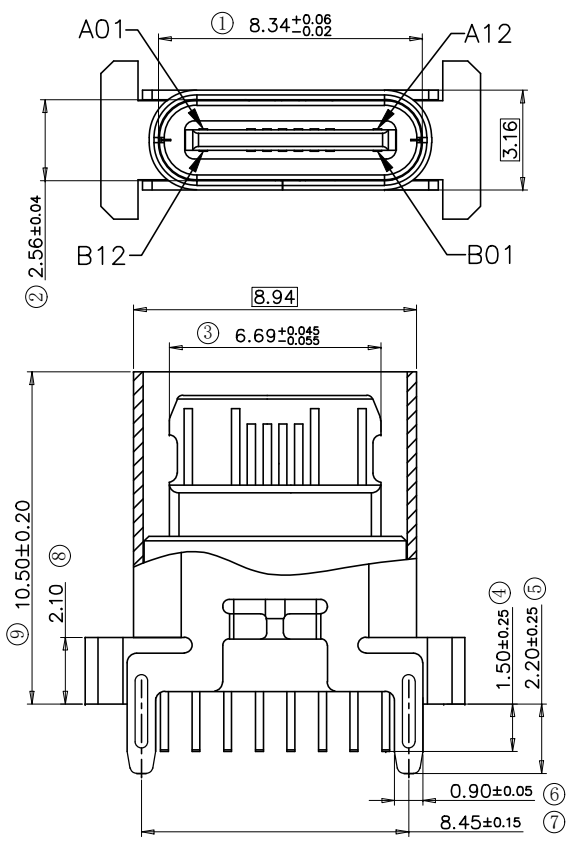

剖视图

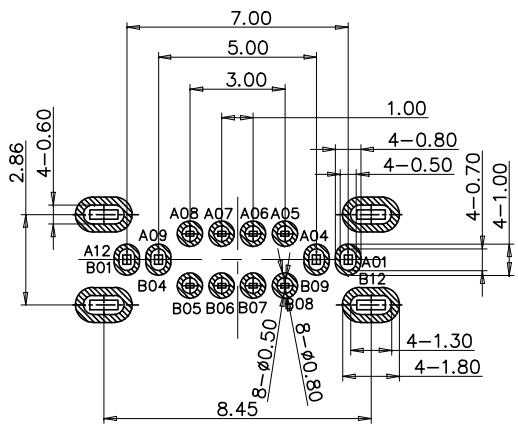

RECOMMENDED P.C.B. LAYOUT (T:1.00mm)  
TOLERANCE UNSPECIFIED ±0.05mm

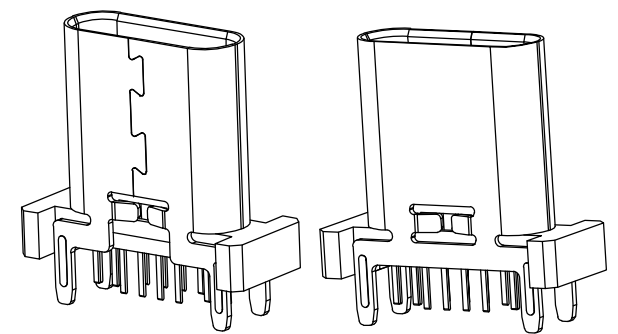

- 特性:
- 一、电气性能: ELCTRICAL
    1. 额定电流: 5.0A
    2. 接触阻抗: 40MILLIOHMS MAX
    3. 耐电压: 150V AC/1mA MAX
    4. 绝缘阻抗: 150V DC/100 MEGA OHMS MIN
  - 二、机械性能:
    1. 插入力: 5~20N
    2. 插拔力: 8~20N
    3. 使用寿命: 10000次, 拔出力 5N MIN
  - 三、材料: MATERIAL
    1. 塑胶: LCP/PA9T UL94V-0
    2. 端子: C7025/C1814 T=0.15mm
    3. 外壳: SUS304 T=0.3mm
    4. 卡勾: SUS304 T=0.15mm
  - 四、电镀: FINISH
    1. 端子: 接触点镀金 3U MIN PIN脚焊接区域镀金 1U' MIN
    2. 外壳: 镀镍 50U' MIN (盐雾 48H)
  - 五、电镀品需做沾锡测试: 粘锡面积达到 95% 以上。
  - 六、SMT回流焊 (峰值 260°C ± 5°C) 不能起泡 熔胶、变色不良 (变形在公差范围内)
  - 七、工作温度: -40°C ~ +85°C

A1	GND	B12	GND
A4	VBUS	B9	VBUS
A5	CC1	B8	SBU2
A6	D+	B7	D-
A7	D-	B6	D+
A8	SBU1	B5	CC2
A9	VBUS	B4	VBUS
A12	GND	B1	GND
PIN	SIGNAL NAME	PIN	SIGNAL NAME

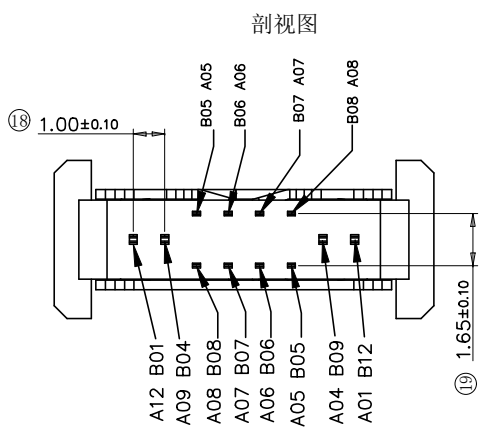

UNLESS OTHERWISE SPECIFIED TOLERANCES		东莞市汉博电子科技有限公司 DONGGUAN HANBO TECHNOLOGY CO., LTD			
DECIMALS:	ANGLES:	TITLE	TYPE-C 16PIN 母座立插A款H=10.5		
X : ±0.25	X : ±2°	DWN	xiong	PART NO. MC-110LD-L105	
X.X : ±0.20	X.X : ±1°	CHKD	lee	SCALE: 1:1	UNIT: mm
X.XX : ±0.15		APVD	wang	SIZE: A4	SHEET: 10F 1
REV: A4					
CUSTOMER COPY					



REV.	ECN NO OR DESCRIPTION	REVISED	DATE

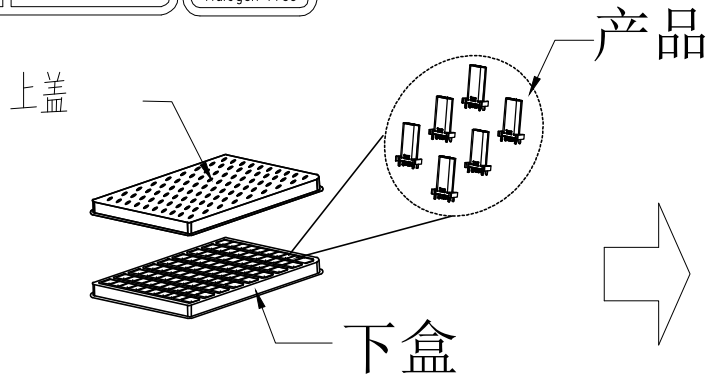

① PE真空盒(1Set).

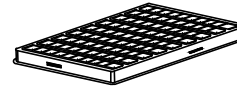

② 100Pcs/盒

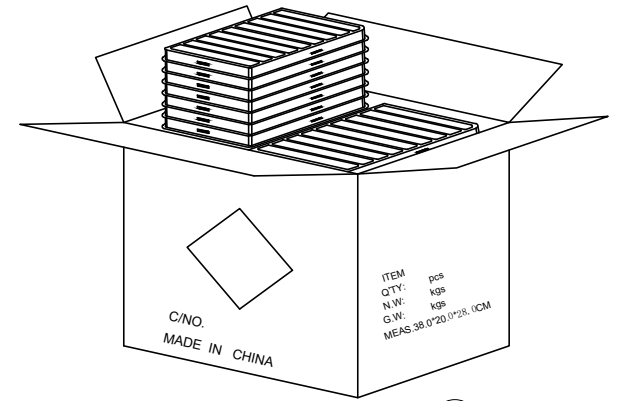

③ 50盒/箱(5k).

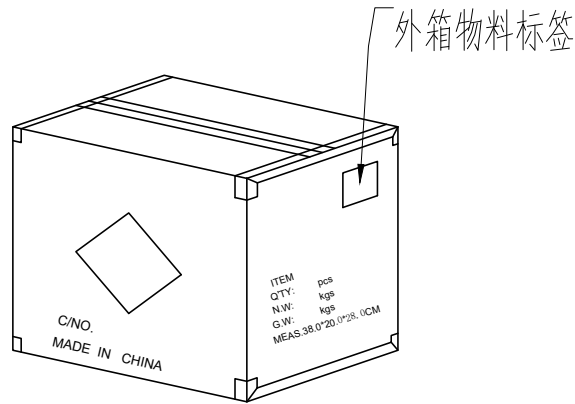

⑥ 依图示粘贴产品或ROHS标签。

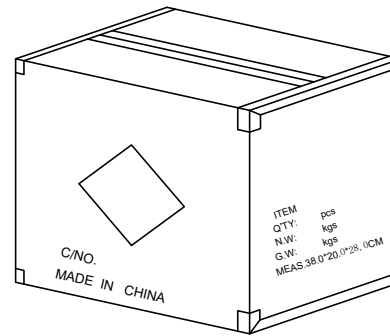

⑤ 外箱用透明胶纸带封“工”字型。

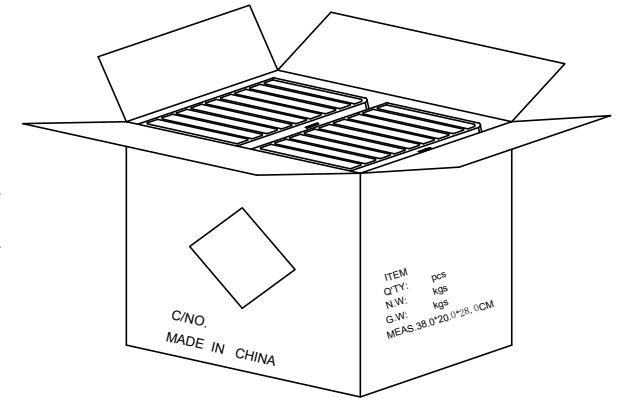

④ 每箱竖放25盒\*2, 若尾数箱在空间处加装填充物。

备注:

1. PE真空盒1set
2. 每盒装成品100Pcs, 四周并用订书机装订;
3. 每箱数量见表一
4. 外箱尺寸与规格: 38\*20\*28CM
5. 外箱用透明胶纸带封“工”字型;

UNLESS OTHERWISE SPECIFIED TOLERANCES		东莞市汉博电子科技有限公司 DONGGUAN HANBO TECHNOLOGY CO., LTD			
DECIMALS:	ANGLES:	TITLE	TYPE-C 16PIN母座 立插A款 H=10.5		
X :±0.25	X :±2°	DWN	xiong	PART NO. MC-110LD-L105	
X.X :±0.20	X.X :±1°	CHKD	lee	SCALE:1:1	UNIT: mm
X.XX :±0.15		APVD	wang	SIZE: A4	SHEET:10F 1
				REV: A4	
CUSTOMER COPY					