



- ★ Super Low Gate Charge
- ★ 100% EAS Guaranteed
- ★ Green Device Available
- ★ Excellent CdV/dt effect decline
- ★ Advanced high cell density Trench technology

**Product Summary**

BVDSS	R <sub>DS(on)</sub>	I <sub>D</sub>
30V	9mΩ	15.0A

**Description**

The IRF7201TRPBF is the high cell density trenched N-ch MOSFETs, which provide excellent R<sub>DS(on)</sub> and gate charge for most of the synchronous buck converter applications. The IRF7201TRPBF meet the RoHS and Green Product requirement, 100% EAS guaranteed with full function reliability approved.

**SOP8 Pin Configuration**

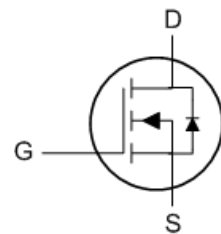
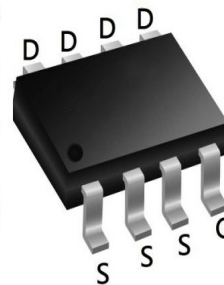

**Absolute Maximum Ratings**

Symbol	Parameter	Rating	Units
V <sub>DS</sub>	Drain-Source Voltage	30	V
V <sub>GS</sub>	Gate-Source Voltage	±20	V
I <sub>D</sub> @T <sub>A</sub> =25°C	Continuous Drain Current, V <sub>GS</sub> @ 10V <sup>1</sup>	15.0	A
I <sub>D</sub> @T <sub>A</sub> =70°C	Continuous Drain Current, V <sub>GS</sub> @ 10V <sup>1</sup>	8.2	A
I <sub>DM</sub>	Pulsed Drain Current <sup>2</sup>	42	A
EAS	Single Pulse Avalanche Energy <sup>3</sup>	61	mJ
I <sub>AS</sub>	Avalanche Current	35	A
P <sub>D</sub> @T <sub>A</sub> =25°C	Total Power Dissipation <sup>4</sup>	1.5	W
T <sub>STG</sub>	Storage Temperature Range	-55 to 150	°C
T <sub>J</sub>	Operating Junction Temperature Range	-55 to 150	°C

**Thermal Data**

Symbol	Parameter	Typ.	Max.	Unit
R <sub>θJA</sub>	Thermal Resistance Junction-ambient <sup>1</sup>	---	85	°C/W
R <sub>θJC</sub>	Thermal Resistance Junction-Case <sup>1</sup>	---	36	°C/W



**Electrical Characteristics ( $T_J=25^\circ\text{C}$ , unless otherwise noted)**

Symbol	Parameter	Conditions	Min.	Typ.	Max.	Unit
$BV_{DSS}$	Drain-Source Breakdown Voltage	$V_{GS}=0V, I_D=250\mu A$	30	---	---	V
$\Delta BV_{DSS}/\Delta T_J$	$BV_{DSS}$ Temperature Coefficient	Reference to $25^\circ\text{C}$ , $I_D=1mA$	---	0.027	---	$V/^\circ\text{C}$
$R_{DS(on)}$	Static Drain-Source On-Resistance <sup>2</sup>	$V_{GS}=10V, I_D=10A$	---	7.5	9	m $\Omega$
		$V_{GS}=4.5V, I_D=8A$	---	11	14	
$V_{GS(th)}$	Gate Threshold Voltage	$V_{GS}=V_{DS}, I_D=250\mu A$	1.2	1.5	2.5	V
$\Delta V_{GS(th)}$	$V_{GS(th)}$ Temperature Coefficient		---	-5.8	---	$mV/^\circ\text{C}$
$I_{DSS}$	Drain-Source Leakage Current	$V_{DS}=24V, V_{GS}=0V, T_J=25^\circ\text{C}$	---	---	1	$\mu A$
		$V_{DS}=24V, V_{GS}=0V, T_J=55^\circ\text{C}$	---	---	5	
$I_{GSS}$	Gate-Source Leakage Current	$V_{GS}=\pm 20V, V_{DS}=0V$	---	---	$\pm 100$	nA
$g_{fs}$	Forward Transconductance	$V_{DS}=5V, I_D=10A$	---	5.8	---	S
$R_g$	Gate Resistance	$V_{DS}=0V, V_{GS}=0V, f=1MHz$	---	2.2	3.8	$\Omega$
$Q_g$	Total Gate Charge (4.5V)	$V_{DS}=15V, V_{GS}=4.5V, I_D=10A$	---	12.6	17.6	nC
$Q_{gs}$	Gate-Source Charge		---	4.2	5.9	
$Q_{gd}$	Gate-Drain Charge		---	5.1	7.1	
$T_{d(on)}$	Turn-On Delay Time	$V_{DD}=15V, V_{GS}=10V, R_G=3.3\Omega, I_D=10A$	---	6.2	12.4	ns
$T_r$	Rise Time		---	59	106	
$T_{d(off)}$	Turn-Off Delay Time		---	27.6	55	
$T_f$	Fall Time		---	8.4	16.8	
$C_{iss}$	Input Capacitance	$V_{DS}=15V, V_{GS}=0V, f=1MHz$	---	1317	1845	pF
$C_{oss}$	Output Capacitance		---	163	228.2	
$C_{riss}$	Reverse Transfer Capacitance		---	131	183.4	

**Diode Characteristics**

Symbol	Parameter	Conditions	Min.	Typ.	Max.	Unit
$I_S$	Continuous Source Current <sup>1,5</sup>	$V_G=V_D=0V$ , Force Current	---	---	10.3	A
$I_{SM}$	Pulsed Source Current <sup>2,5</sup>		---	---	42	A
$V_{SD}$	Diode Forward Voltage <sup>2</sup>	$V_{GS}=0V, I_S=1A, T_J=25^\circ\text{C}$	---	---	1.2	V
$t_{rr}$	Reverse Recovery Time	$I_F=10A, di/dt=100A/\mu s, T_J=25^\circ\text{C}$	---	12.5	---	nS
$Q_{rr}$	Reverse Recovery Charge		---	5	---	nC

Note :

- 1.The data tested by surface mounted on a 1 inch<sup>2</sup> FR-4 board with 20Z copper.
- 2.The data tested by pulsed , pulse width  $\leq 300\mu s$ , duty cycle  $\leq 2\%$
- 3.The EAS data shows Max. rating . The test condition is  $V_{DD}=25V, V_{GS}=10V, L=0.1mH, I_{AS}=35A$
- 4.The power dissipation is limited by  $150^\circ\text{C}$  junction temperature
- 5.The data is theoretically the same as  $I_D$  and  $I_{DM}$ , in real applications , should be limited by total power dissipation.



**Typical Characteristics**

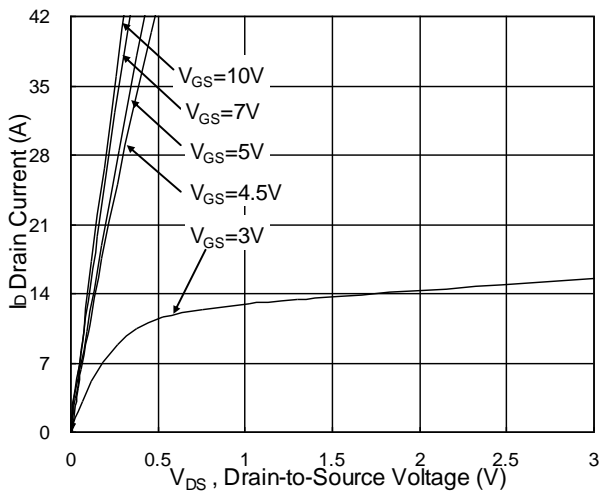

**Fig.1 Typical Output Characteristics**

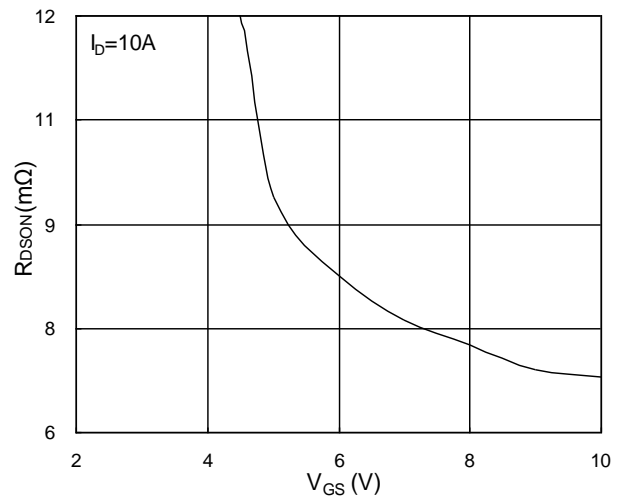

**Fig.2 On-Resistance vs. Gate-Source**

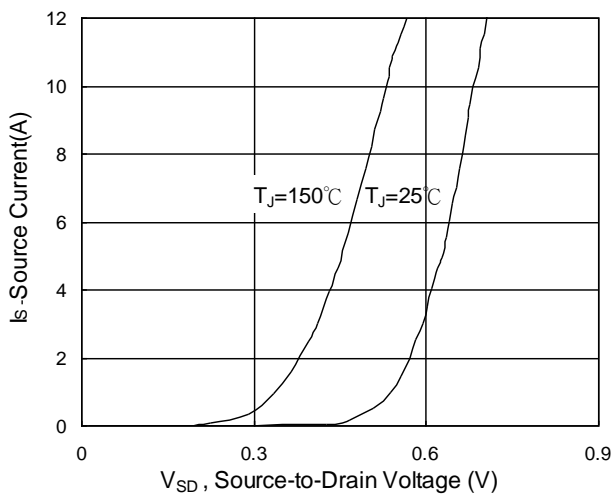

**Fig.3 Forward Characteristics of reverse**

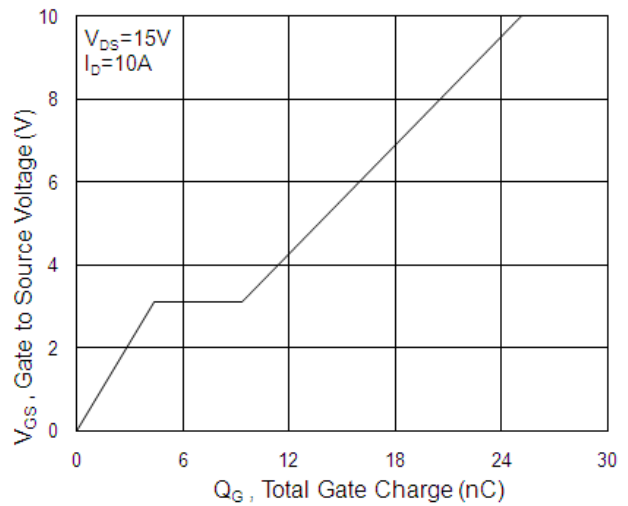

**Fig.4 Gate-Charge Characteristics**

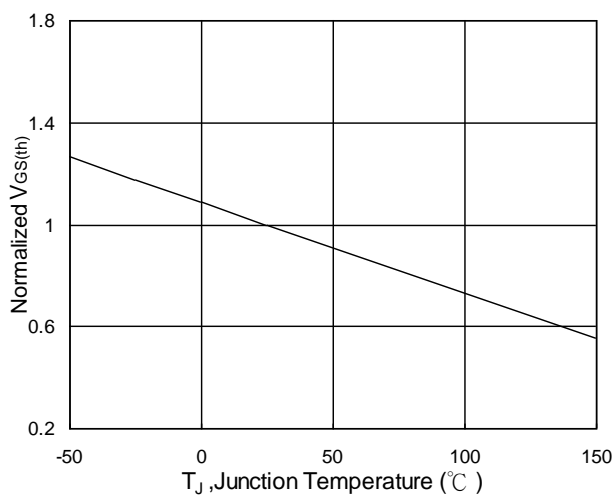

**Fig.5 Normalized  $V_{GS(th)}$  vs.  $T_J$**

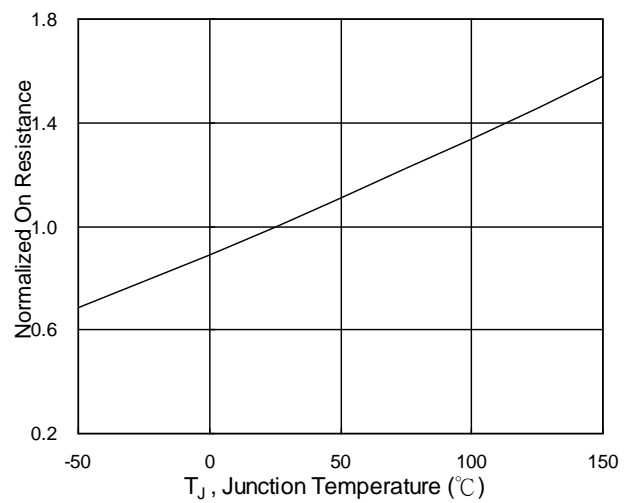

**Fig.6 Normalized  $R_{DS(on)}$  vs.  $T_J$**

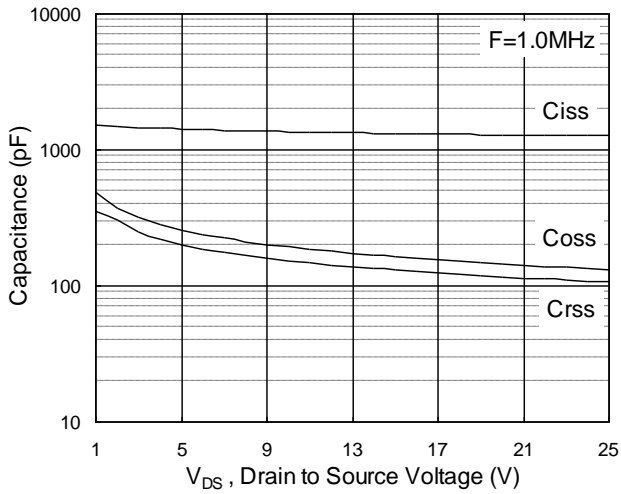

Fig.7 Capacitance

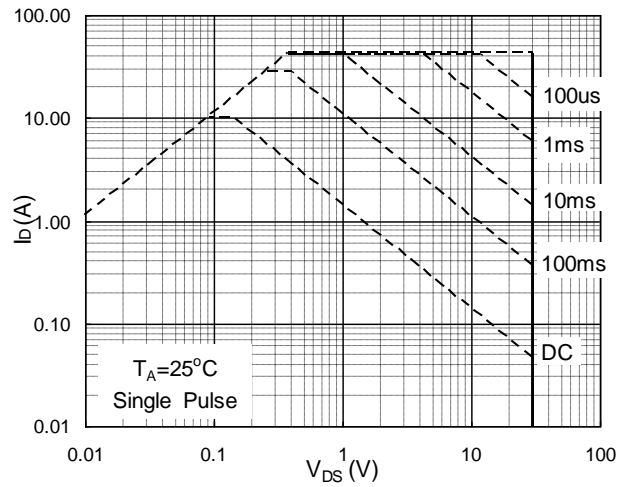

Fig.8 Safe Operating Area

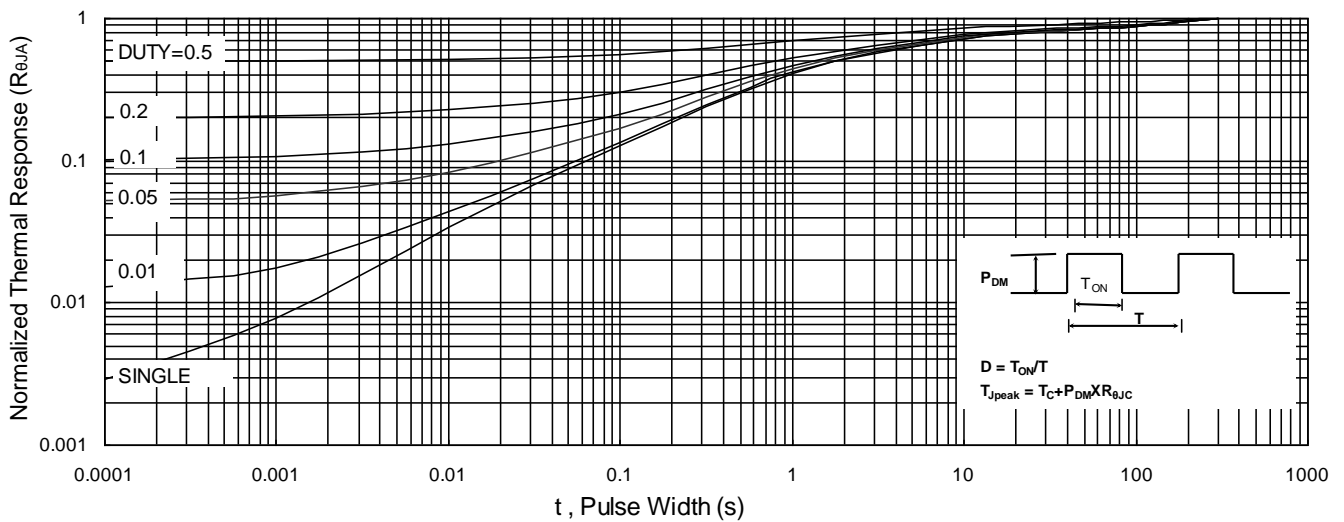

Fig.9 Normalized Maximum Transient Thermal Impedance

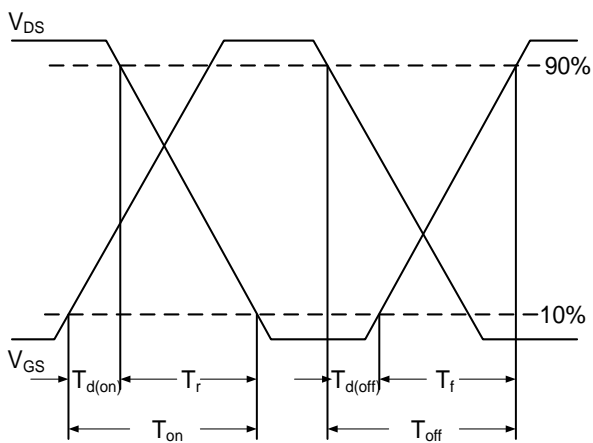

Fig.10 Switching Time Waveform

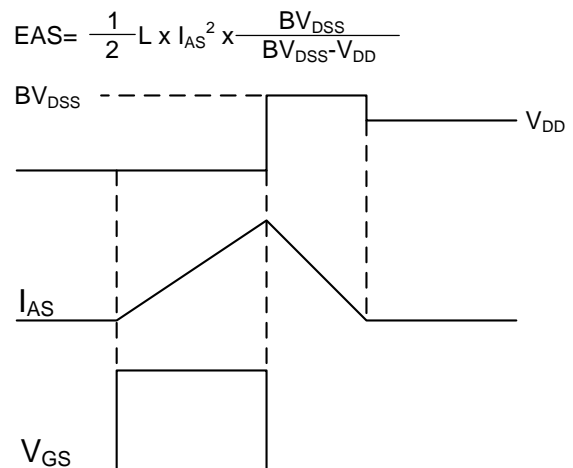

Fig.11 Unclamped Inductive Switching Waveform