

LN2302BLT1G

S-LN2302BLT1G

20V N-Channel Enhancement-Mode MOSFET

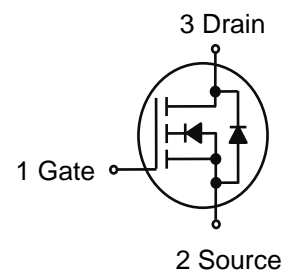
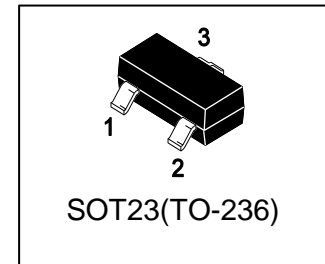

1. FEATURES

- Super high density cell design for extremely low RDS(ON)
- Exceptional on-resistance and maximum DC current capability.
- We declare that the material of product compliance with RoHS requirements and Halogen Free.
- S-prefix for automotive and other applications requiring unique site and control change requirements; AEC-Q101 qualified and PPAP capable.

2. APPLICATIONS

- Power Management in Notebook
- Portable Equipment
- Load Switch
- DSC

3. DEVICE MARKING AND ORDERING INFORMATION

Device	Marking	Shipping
LN2302BLT1G	02B	3000/Tape&Reel
LN2302BLT3G	02B	10000/Tape&Reel

4. MAXIMUM RATINGS(Ta = 25°C)

Parameter	Symbol	Limits	Unit
Drain-Source Voltage	VDSS	20	V
Gate-to-Source Voltage – Continuous	VGS	±8	V
Drain Current	ID	2.8	A
– Continuous TA = 25°C		2.2	
– Pulsed	IDM	10	A
Maximum Body-Diode Continuous Current	IS	1.6	A

5. THERMAL CHARACTERISTICS

Parameter	Symbol	Limits	Unit
Maximum Power Dissipation	PD	1.25	W
		0.8	
Thermal Resistance, Junction-to-Ambient	RθJA	77	°C/W
		105	
Thermal Resistance, Junction-to-Case	RθJC	70	°C/W
Junction and Storage temperature	TJ, Tstg	-55~+150	°C
Operating temperature Range	Top	-55~+150	°C

1. The device mounted on 1in² FR4 board with 2 oz copper

6. ELECTRICAL CHARACTERISTICS (Ta= 25°C)

Characteristic	Symbol	Min.	Typ.	Max.	Unit	
Drain–Source Breakdown Voltage (VGS = 0, ID = 250μA)	V(BR)DSS	20	-	-	V	
Gate Threshold Voltage (VDS = VGS, ID = 250μA)	VGS(th)	0.5	0.75	1	V	
Zero Gate Voltage Drain Current (VDS=20V, VGS=0V) (VDS=20V, VGS=0V, TJ =55°C)	IDSS	-	-	1 10	μA	
Gate–Body Leakage Current (VDS = 0 V, VGS = ±8 V)	IGSS	-	-	±100	nA	
Static Drain–Source On–State Resistance (VGS =4.5V, ID = 2.8A) (VGS =2.5V, ID = 2.5A) (VGS =1.8V, ID = 2.2A)	RDS(on)	-	55 65 80	85 115 130	mΩ	
Forward Voltage (IS =1A, VGS =0V)	VSD	-	0.75	1.2	V	
Input Capacitance (VGS = 0 V, f = 1.0MHz, VDS= 10 V)	Ciss	-	450	-	pF	
Output Capacitance (VGS = 0 V, f = 1.0MHz, VDS= 10 V)	Coss	-	72	-	pF	
Reverse Transfer Capacitance (VGS = 0 V, f = 1.0MHz, VDS= 10 V)	Crss	-	22	-	pF	
Total Gate Charge	(VDS =10V, VGS =4.5V, ID =2.8A)	Qg	-	9	-	nC
Gate–Source Charge		Qgs	-	2.2	-	
Gate–Drain Charge		Qgd	-	3	-	
Turn-On Delay Time	(VDD = 10V, VGEN = 4.5V,RL = 10 Ω ,RG = 6 Ω)	td(on)	-	9	-	ns
Rise Time		tr	-	23	-	
Turn-Off Delay Time		td(off)	-	38	-	
Fall Time		tf	-	3	-	

2.Pulse Test: Pulse Width ≤300 μs, Duty Cycle ≤2.0%.

7. ELECTRICAL CHARACTERISTICS CURVES

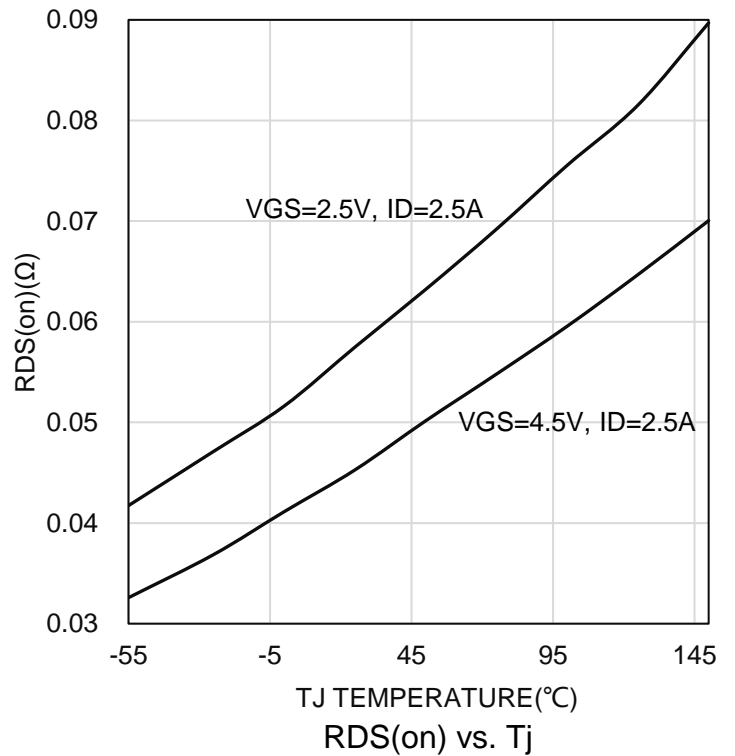
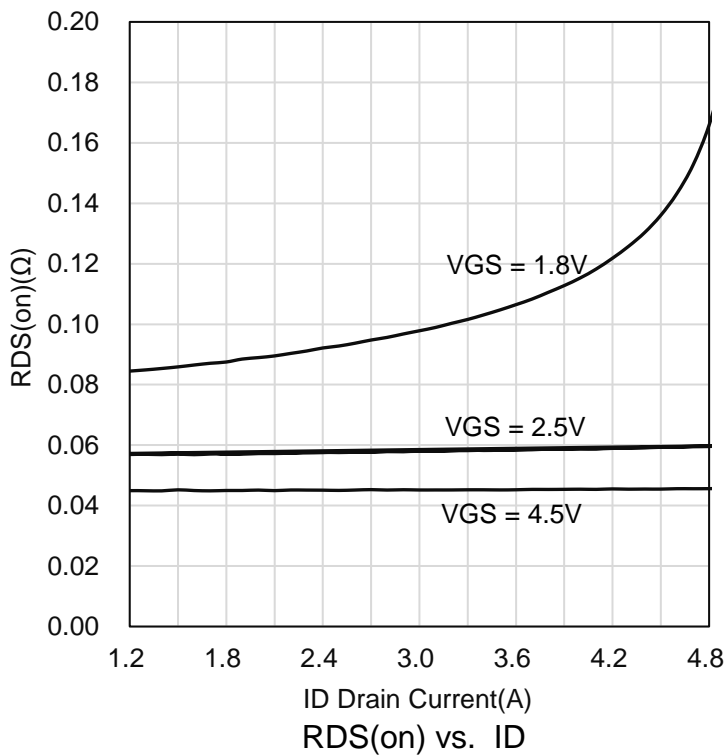
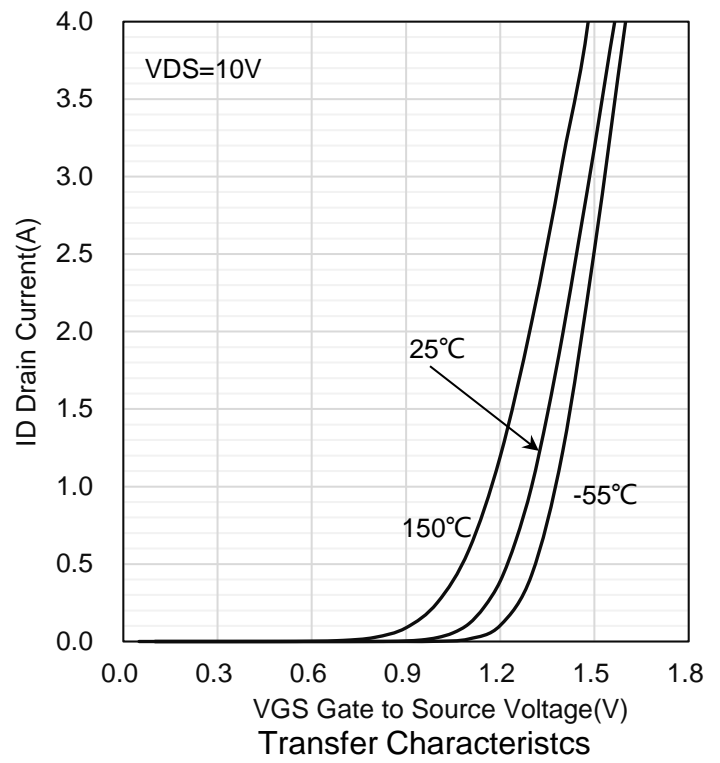
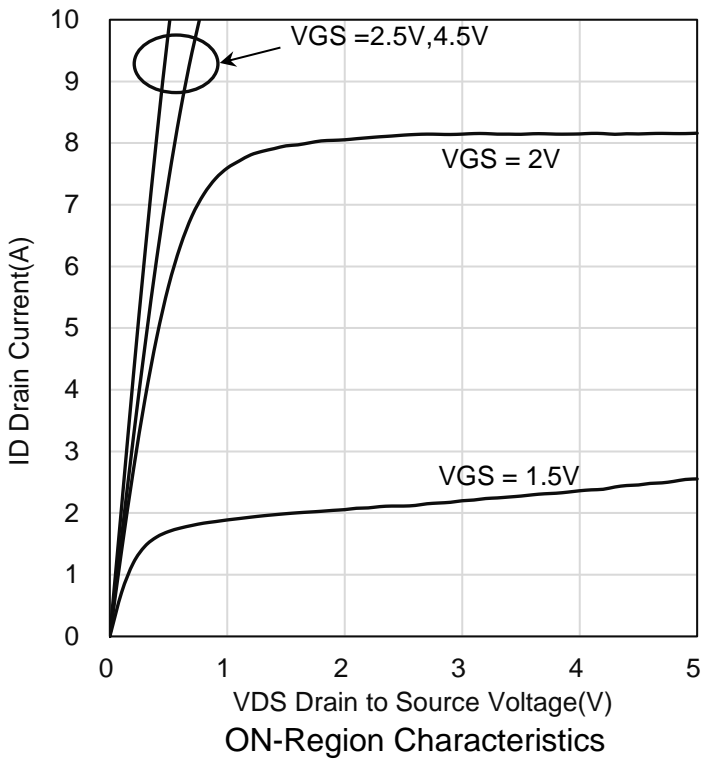

7. ELECTRICAL CHARACTERISTICS CURVES(Con.)

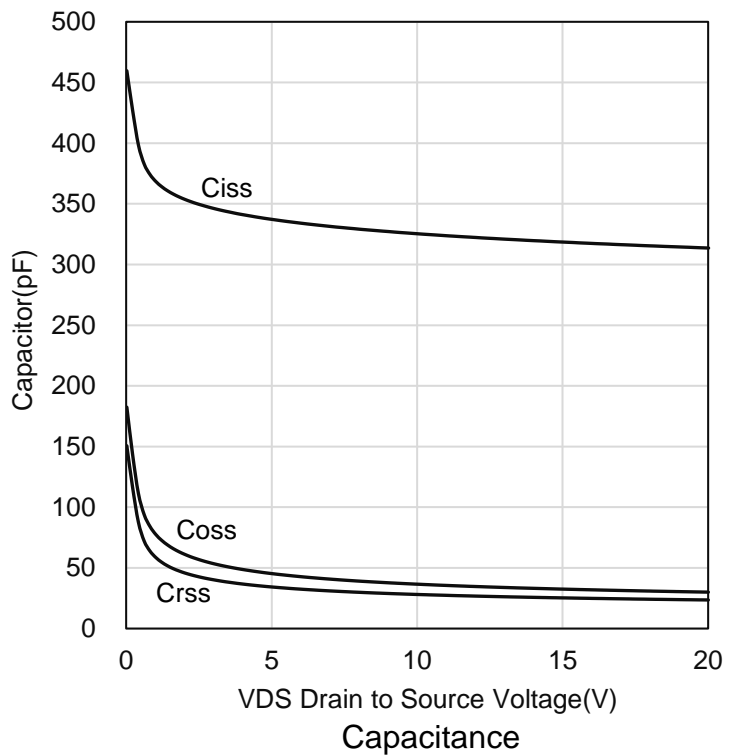
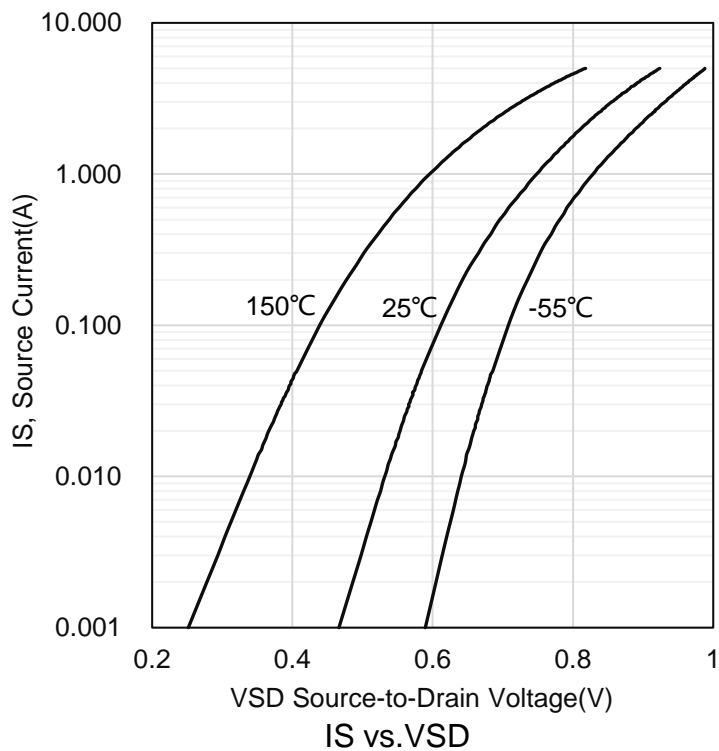
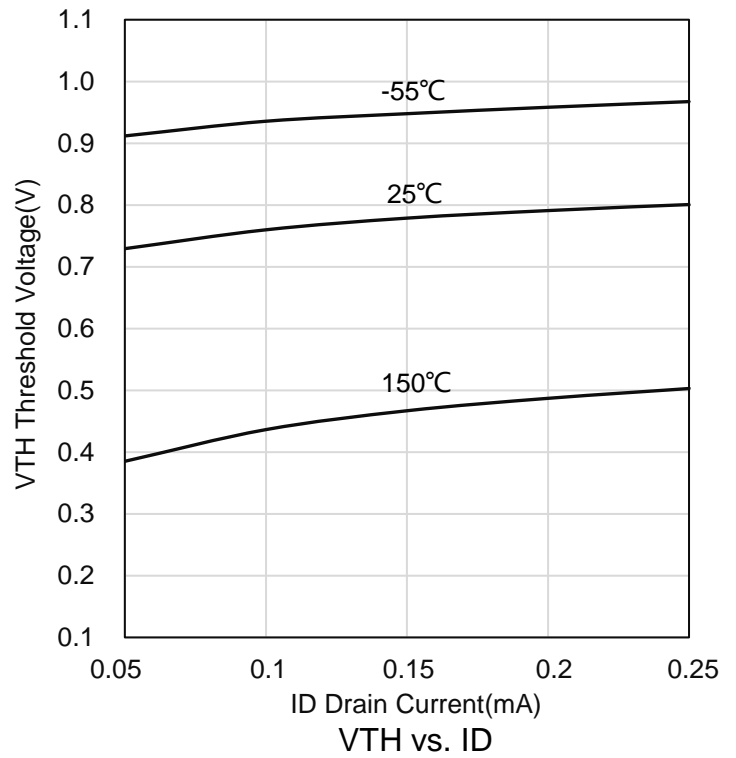
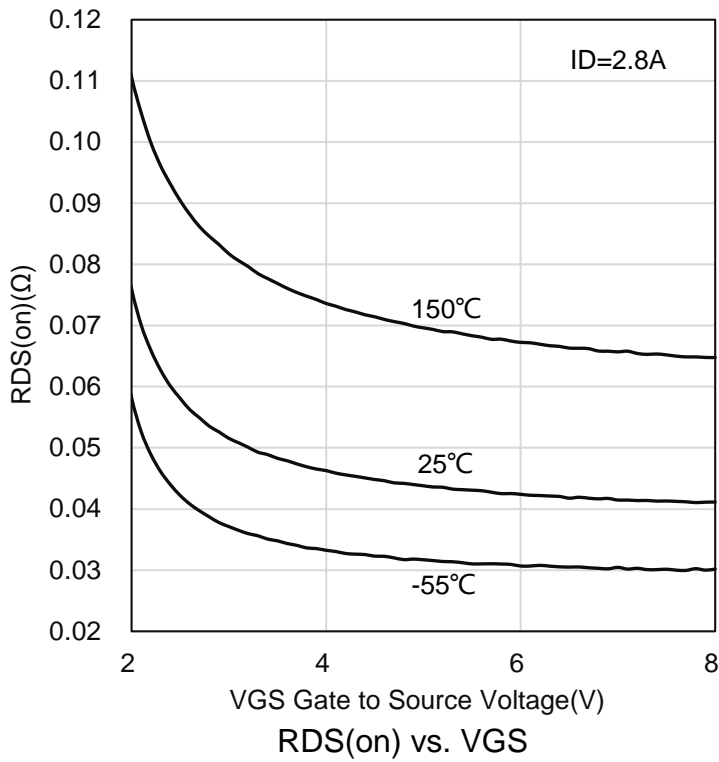

8.OUTLINE AND DIMENSIONS

Notes:

1. DIMENSIONING AND TOLERANCING PER ANSI Y14.5M, 1982.
2. CONTROLLING DIMENSION: MILLIMETERS.
3. MAXIMUM LEAD THICKNESS INCLUDES LEAD FINISH. MINIMUM LEAD THICKNESS IS THE MINIMUM THICKNESS OF BASE MATERIAL.
4. DIMENSIONS D AND E DO NOT INCLUDE MOLD FLASH, PROTRUSIONS OR GATE BURRS.

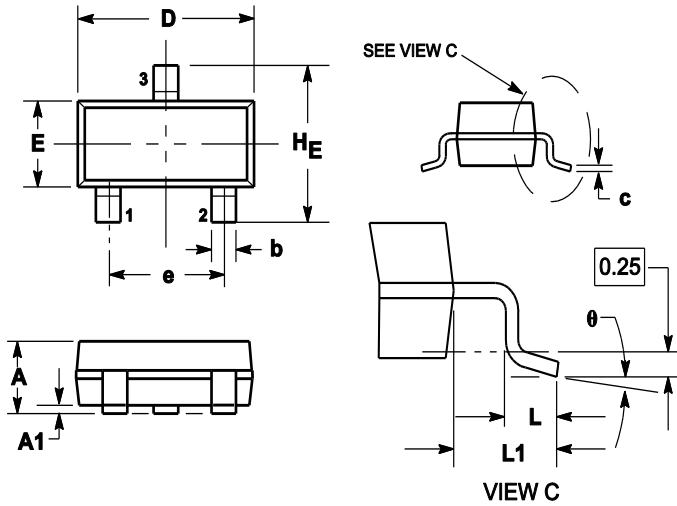

DIM	MILLIMETERS			INCHES		
	MIN	NOM	MAX	MIN	NOM	MAX
A	0.89	1	1.11	0.035	0.04	0.044
A1	0.01	0.06	0.1	0.001	0.002	0.004
b	0.37	0.44	0.5	0.015	0.018	0.02
c	0.09	0.13	0.18	0.003	0.005	0.007
D	2.80	2.9	3.04	0.11	0.114	0.12
E	1.20	1.3	1.4	0.047	0.051	0.055
e	1.78	1.9	2.04	0.07	0.075	0.081
L	0.10	0.2	0.3	0.004	0.008	0.012
L1	0.35	0.54	0.69	0.014	0.021	0.029
HE	2.10	2.4	2.64	0.083	0.094	0.104
θ	0°	---	10°	0°	---	10°

9.SOLDERING FOOTPRINT

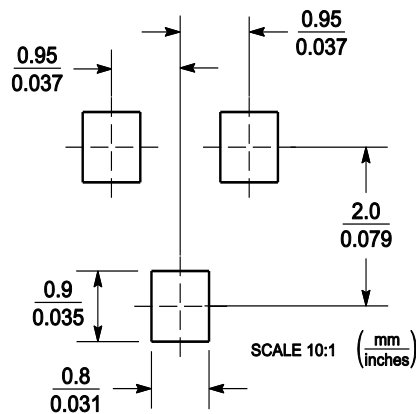

DISCLAIMER

- Before you use our Products, you are requested to carefully read this document and fully understand its contents. LRC shall not be in any way responsible or liable for failure, malfunction or accident arising from the use of any LRC's Products against warning, caution or note contained in this document.
- All information contained in this document is current as of the issuing date and subject to change without any prior notice. Before purchasing or using LRC's Products, please confirm the latest information with a LRC sales representative.