

LN2301GLT1G

20V N-Channel Enhancement-Mode MOSFET

1. FEATURES

- VDS= 20V
- Super high density cell design for extremely low RDS(ON).
- Exceptional on-resistance and maximum DC current capability.
- We declare that the material of product compliance with RoHS requirements and Halogen Free.

2. APPLICATIONS

- Power Management in Notebook
- Portable Equipment
- Load Switch
- DSC

3. DEVICE MARKING AND ORDERING INFORMATION

Device	Marking	Shipping
LN2301GLT1G	02G	3000/Tape&Reel
LN2301GLT3G	02G	10000/Tape&Reel

4. MAXIMUM RATINGS(Ta = 25°C)

Parameter	Symbol	Limits	Unit
Drain-Source Voltage	VDSS	20	V
Gate-to-Source Voltage	VGS	±12	V
Continuous Drain Current TA = 25°C	ID	2	A
Pulsed Drain Current(Note 1)	IDM	8	A
Avalanche Current	IAS	4	A
Avalanche energy L=0.1mH	EAS	0.8	mJ

5. THERMAL CHARACTERISTICS

Parameter	Symbol	Limits	Unit
Maximum Power Dissipation	PD	0.28	W
Thermal Resistance, Junction-to-Ambient(Note 2)	RθJA	450	°C/W
Junction and Storage temperature	TJ,Tstg	-55~+150	°C

1. Repetitive Rating: Pulse width limited by the Maximum junction temperature.
2. 1-in² 2oz Cu PCB board.

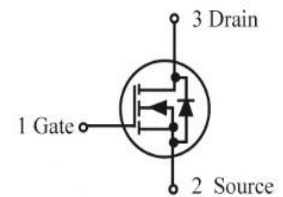
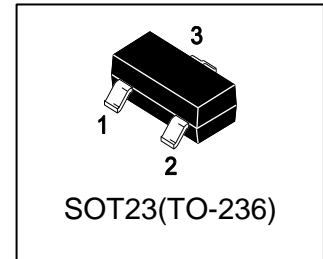

6. ELECTRICAL CHARACTERISTICS (Ta= 25°C)

Characteristic	Symbol	Min.	Typ.	Max.	Unit
Drain-Source Breakdown Voltage (VGS = 0, ID = 250μA)	V(BR)DSS	20	-	-	V
Zero Gate Voltage Drain Current (VDS=20V, VGS=0V)	IDSS	-	-	1	μA
Gate-Body Leakage Current (VDS = 0 V, VGS = ±12 V)	IGSS	-	-	±100	nA
Gate Threshold Voltage (VDS = VGS, ID = 250μA)	VGS(th)	0.45	0.65	0.9	V
Static Drain-Source On-State Resistance (VGS = 4.5 V, ID = 1 A) (VGS = 2.5 V, ID = 1 A)	RDS(on)	- -	- -	69 80	mΩ
Input Capacitance (VGS = 0 V, f = 1.0MHz, VDS= 10 V)	Ciss	-	180	-	pF
Output Capacitance (VGS = 0 V, f = 1.0MHz, VDS= 10 V)	Coss	-	21	-	
Reverse Transfer Capacitance (VGS = 0 V, f = 1.0MHz, VDS= 10 V)	Crss	-	19	-	
Total Gate Charge	(VDS = 10V, VGS = 4.5V, ID=1A)	Qg	-	2.2	nC
Gate-Source Charge		Qgs	-	0.2	
Gate-Drain Charge		Qgd	-	0.6	
Turn-On Delay Time	(VDD = 10V, RL = 10Ω, VGEN = 4.5V, RG = 6Ω)	td(on)	-	2.5	ns
Rise Time		tr	-	0.5	
Turn-Off Delay Time		td(off)	-	15	
Fall Time		tf	-	5.5	
Forward Voltage (VGS = 0 V, IS = 1 A)	VSD	-	-	1.2	V
Gate-Resistance	Rg	-	9	-	Ω

3.Pulse Test: Pulse Width ≤300 μs, Duty Cycle ≤2.0%.

7. ELECTRICAL CHARACTERISTICS CURVES

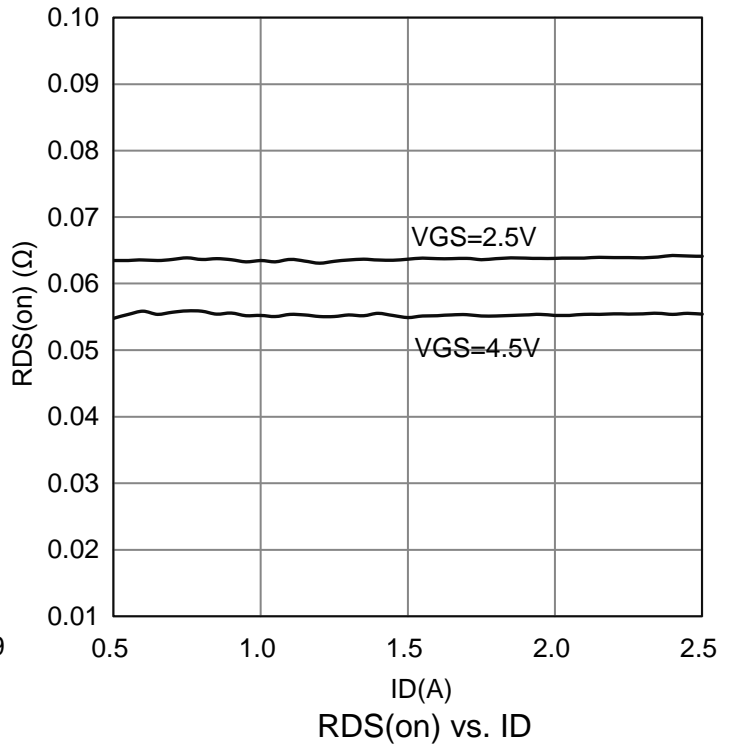
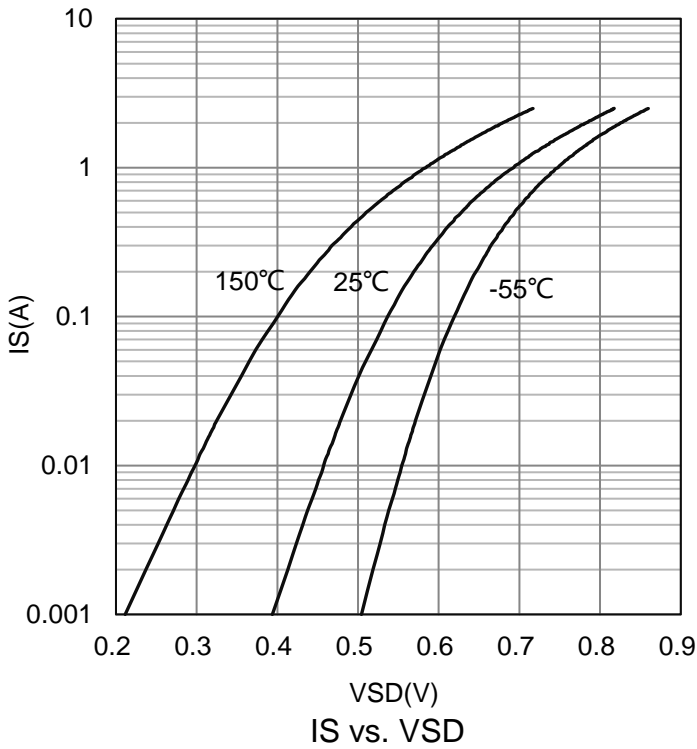
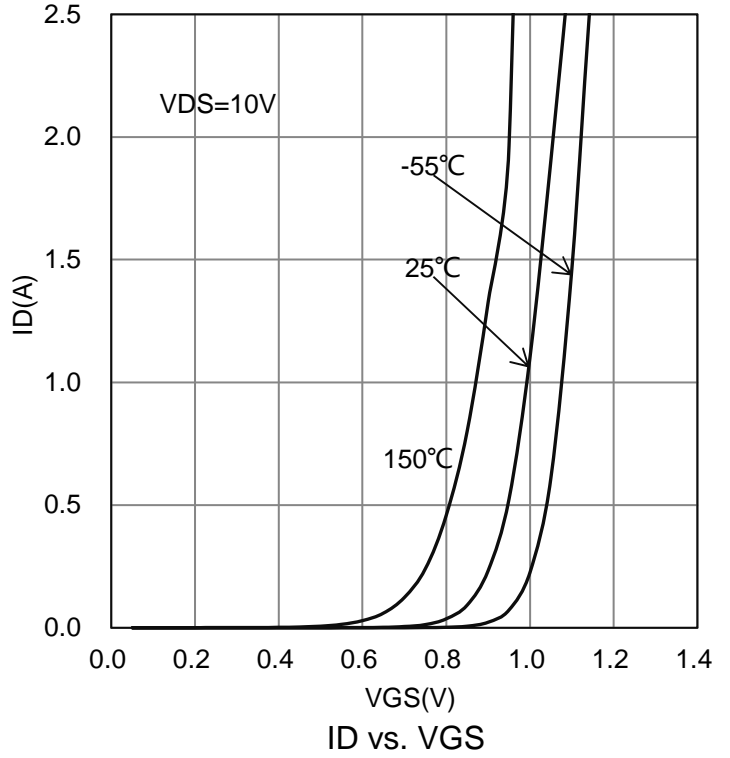
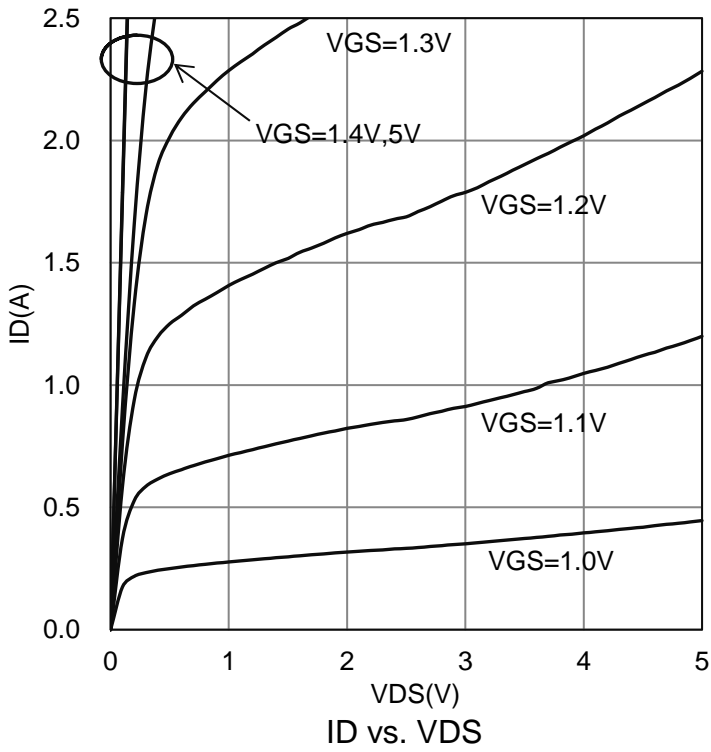

7.ELECTRICAL CHARACTERISTICS CURVES(Con.)

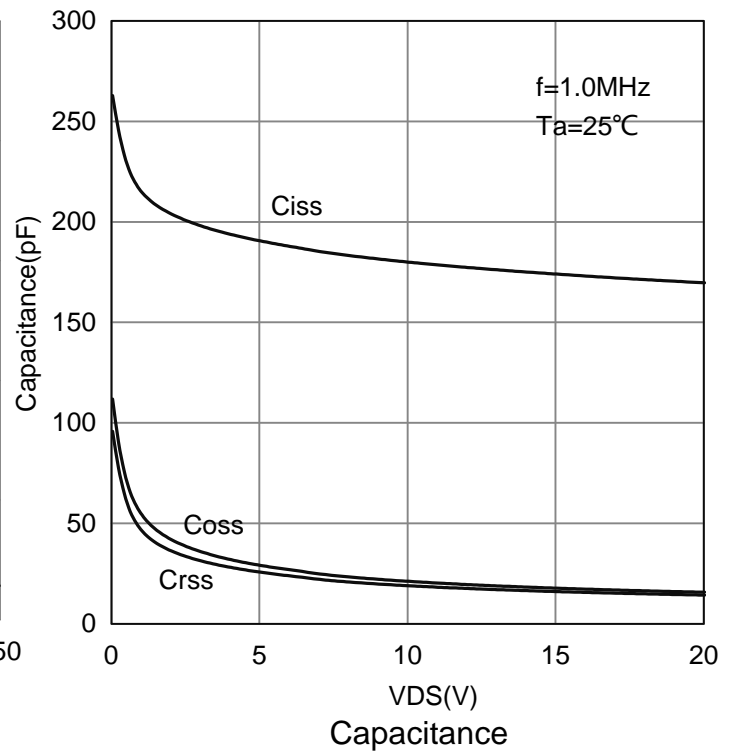
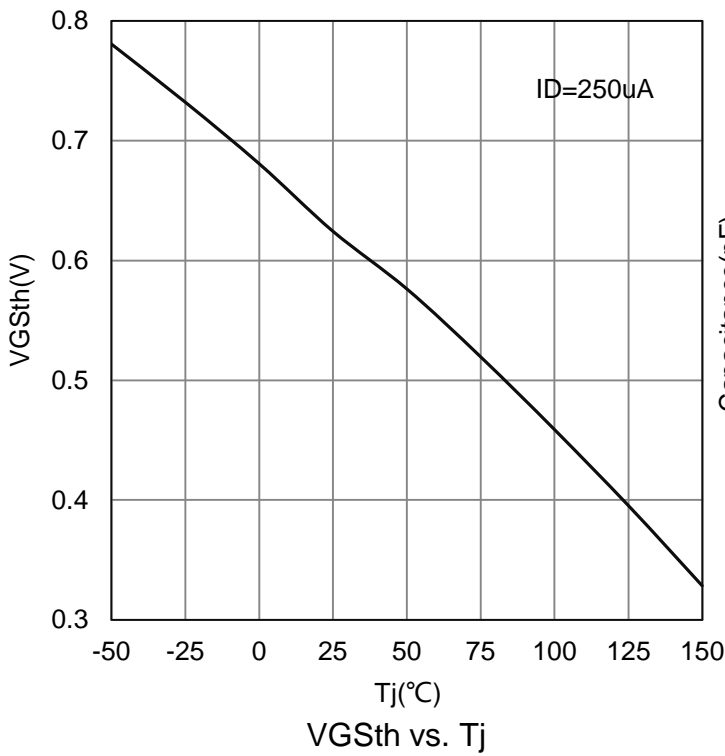
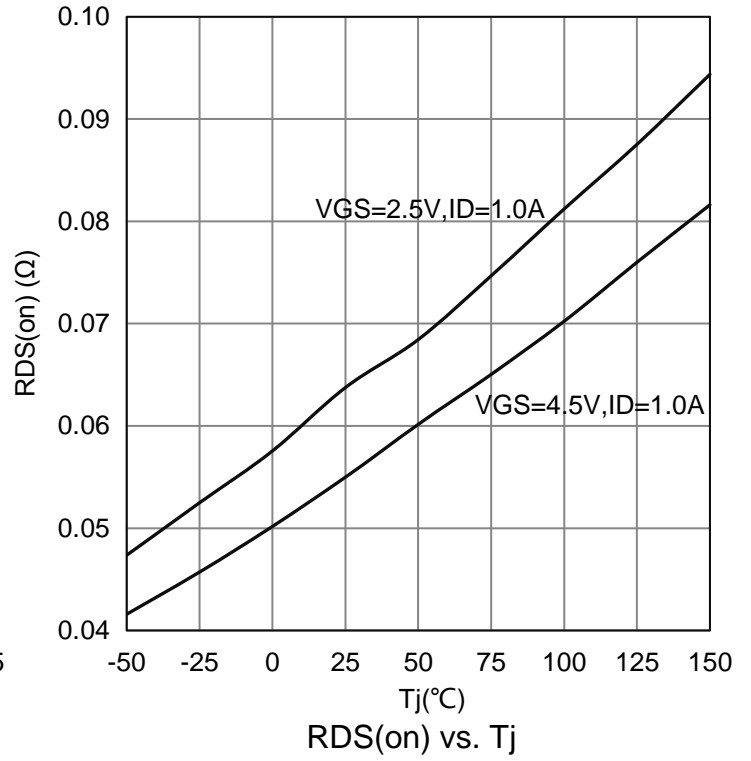
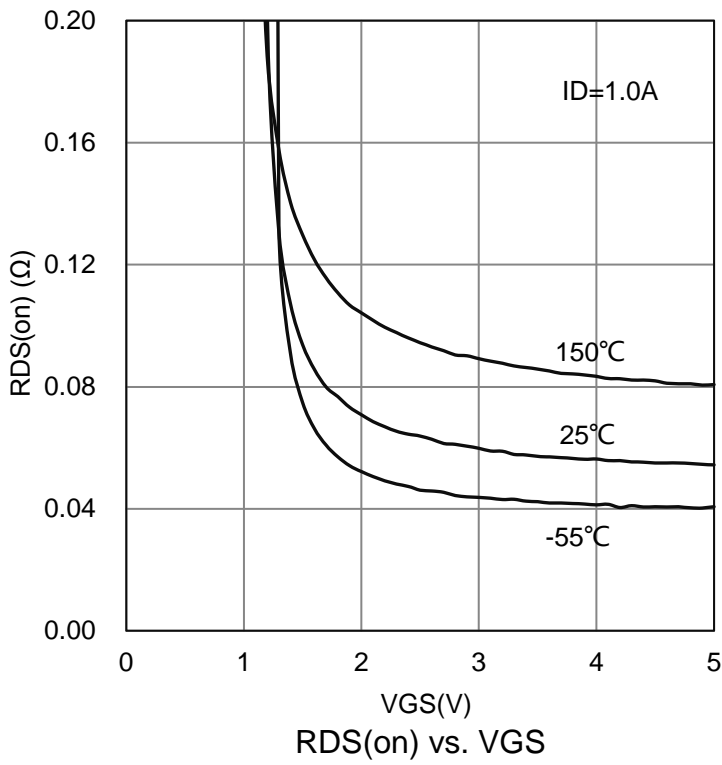

8. OUTLINE AND DIMENSIONS

Notes:

1. DIMENSIONING AND TOLERANCING PER ANSI Y14.5M, 1982.
2. CONTROLLING DIMENSION: MILLIMETERS.
3. MAXIMUM LEAD THICKNESS INCLUDES LEAD FINISH. MINIMUM LEAD THICKNESS IS THE MINIMUM THICKNESS OF BASE MATERIAL.
4. DIMENSIONS D AND E DO NOT INCLUDE MOLD FLASH, PROTRUSIONS OR GATE BURRS.

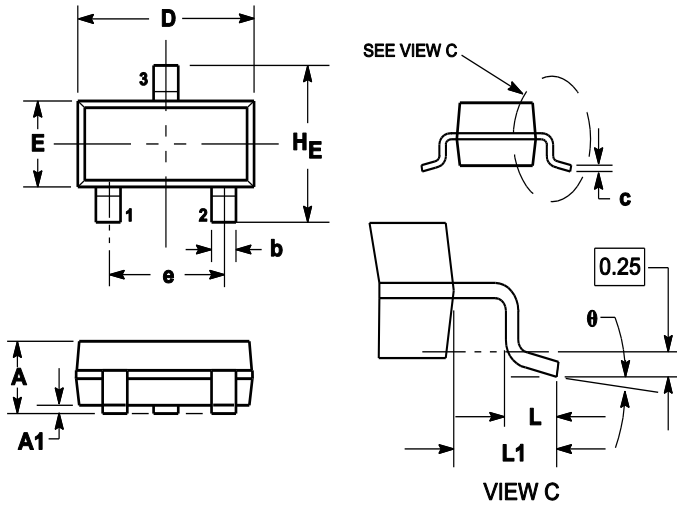

DIM	MILLIMETERS			INCHES		
	MIN	NOM	MAX	MIN	NOM	MAX
A	0.89	1	1.11	0.035	0.04	0.044
A1	0.01	0.06	0.1	0.001	0.002	0.004
b	0.37	0.44	0.5	0.015	0.018	0.02
c	0.09	0.13	0.18	0.003	0.005	0.007
D	2.80	2.9	3.04	0.11	0.114	0.12
E	1.20	1.3	1.4	0.047	0.051	0.055
e	1.78	1.9	2.04	0.07	0.075	0.081
L	0.10	0.2	0.3	0.004	0.008	0.012
L1	0.35	0.54	0.69	0.014	0.021	0.029
HE	2.10	2.4	2.64	0.083	0.094	0.104
θ	0°	---	10°	0°	---	10°

9. SOLDERING FOOTPRINT

