

LMUN2213LT1G

S-LMUN2213LT1G

Bias Resistor Transistor
NPN Silicon Surface Mount Transistor
with Monolithic Bias Resistor Network

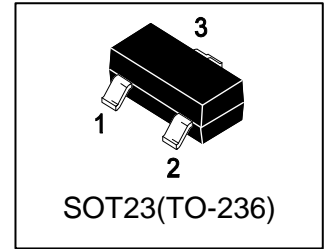

1. FEATURES

- Simplifies circuit design
- Reduces board space and component count
- We declare that the material of product compliance with RoHS requirements and Halogen Free.
- S- prefix for automotive and other applications requiring unique site and control change requirements; AEC-Q101 qualified and PPAP capable.

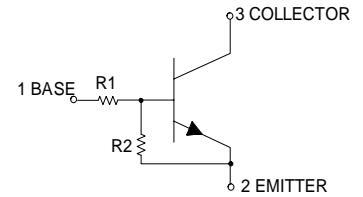

2. DEVICE MARKING AND RESISTOR VALUES

Device	Marking	R1(K)	R2(K)	Vin(V)	Shipping
LMUN2213LT1G	A8C	47	47	-10+40	3000/Tape&Reel

3. MAXIMUM RATINGS(Ta = 25°C)

Parameter	Symbol	Limits	Unit
Collector–Emitter Voltage	VCEO	50	V
Collector–Base Voltage	VCBO	50	V
Collector Current — Continuous	IC	100	mA

4. THERMAL CHARACTERISTICS

Parameter	Symbol	Limits	Unit
Total Device Dissipation, FR-5 Board (Note 1) @ TA = 25°C Derate above 25°C	PD	246 1.5	mW mW/°C
Thermal Resistance, Junction–to–Ambient(Note 1)	ROJA	508	°C/W
Junction and Storage temperature	TJ,Tstg	-55~+150	°C

1. FR-5 @ Minimum Pad.

5. ELECTRICAL CHARACTERISTICS (Ta= 25°C)

OFF CHARACTERISTICS

Characteristic	Symbol	Min.	Typ.	Max.	Unit
Collector–Emitter Breakdown Voltage (IC = 2.0 mA, IB = 0)	VBR(CEO)	50	-	-	V
Collector–Base Breakdown Voltage (IC = 10 μA, IE = 0)	VBR(CBO)	50	-	-	V
Collector-Base Cutoff Current (VCB = 50 V, IE = 0)	ICBO	-	-	100	nA
Collector-Emitter Cutoff Current (VCE = 50 V, IB = 0)	ICEO	-	-	500	nA
Emitter-Base Cutoff Current (VEB = 6.0 V, IC = 0)	IEBO	-	-	0.1	mA

ON CHARACTERISTICS (Note 2.)

DC Current Gain (IC = 5.0 mA, VCE = 10 V)	HFE	80	140	-	
Collector–Emitter Saturation Voltage (IC = 10 mA, IB = 0.3 mA)	VCE(sat)	-	-	0.25	V
Output Voltage (on) (VCC = 5.0 V, VB = 3.5 V, RL = 1.0KΩ)	VOL	-	-	0.2	V
Output Voltage (on) (VCC = 5.0 V, VB = 0.5 V, RL = 1.0KΩ)	VOH	4.9	-	-	V
Input Resistor	R1	32.9	-	61.1	KΩ
Resistor Ratio	R1/R2	0.8	-	1.2	

2. Pulse Test: Pulse Width < 300 μs, Duty Cycle < 2.0%

6.ELECTRICAL CHARACTERISTICS CURVES

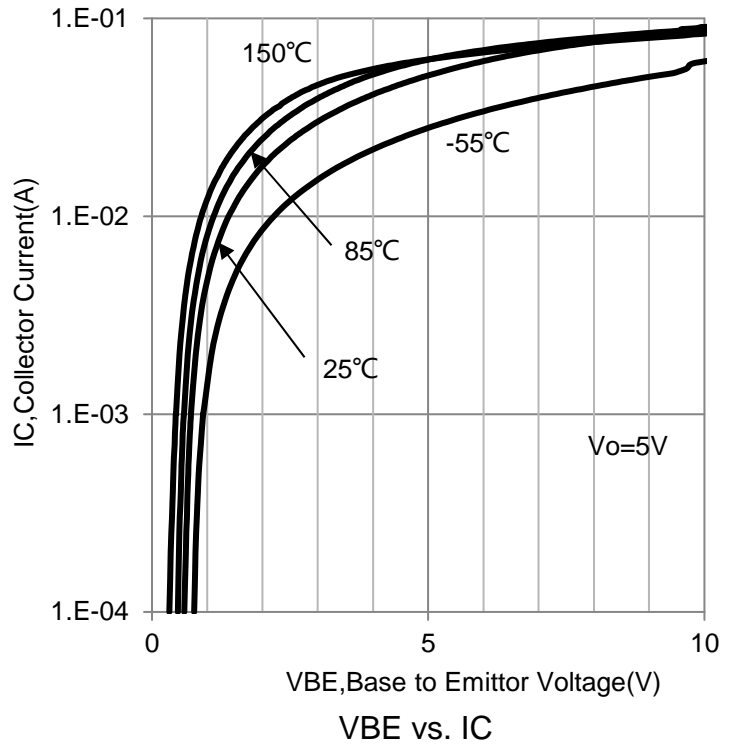
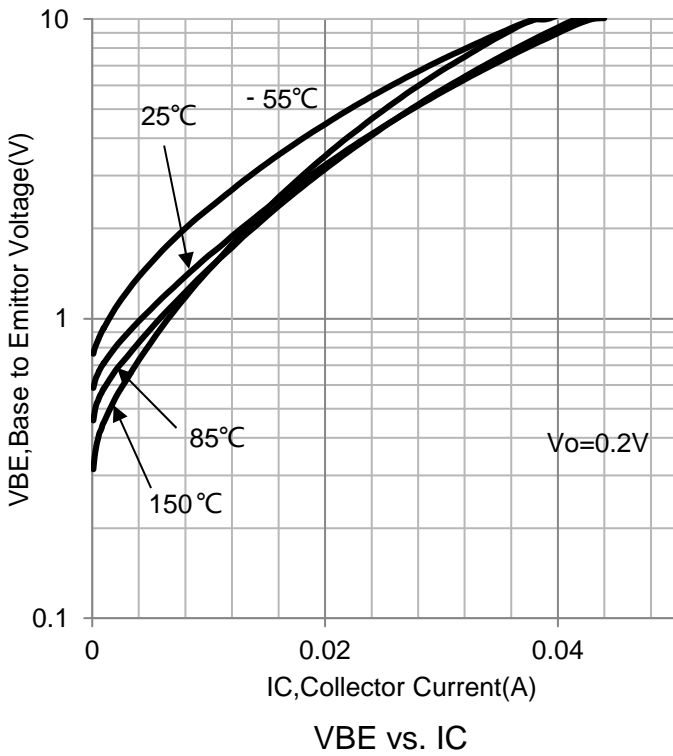
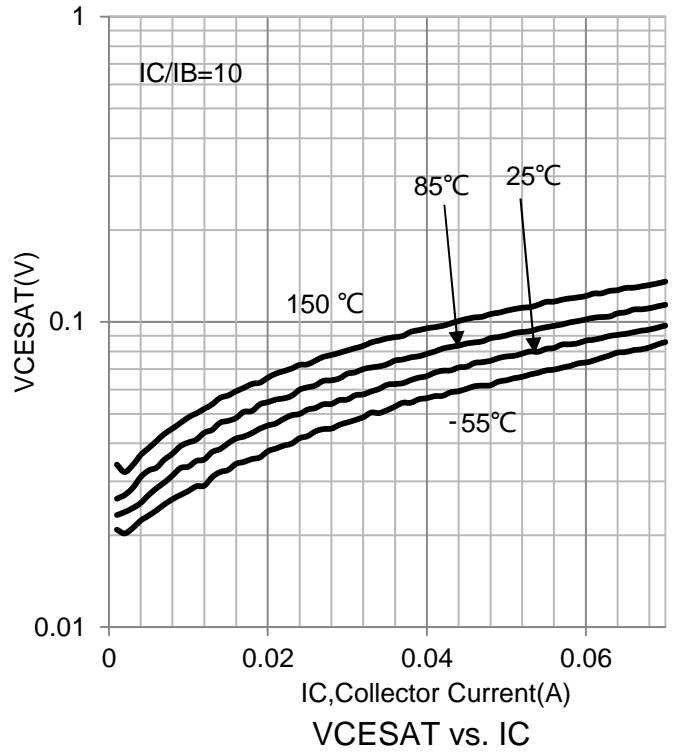
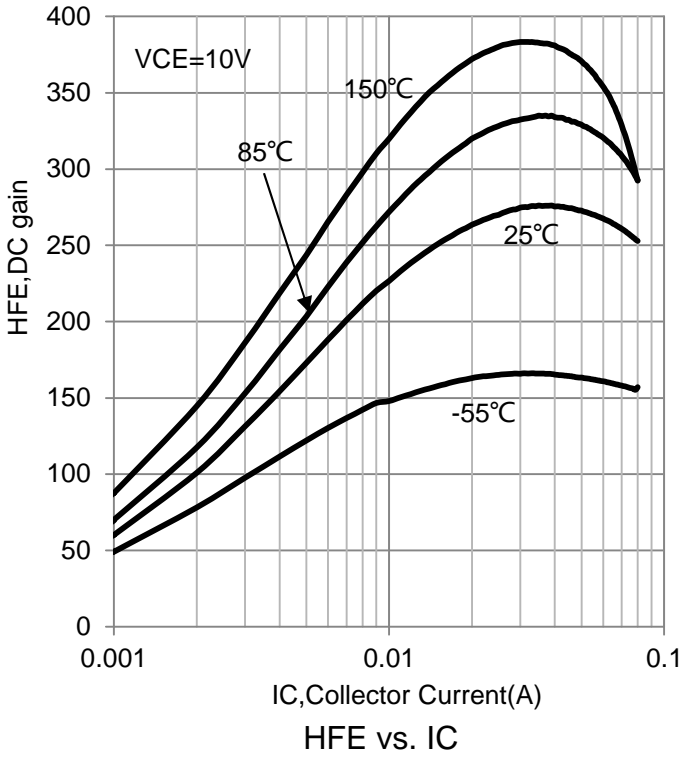

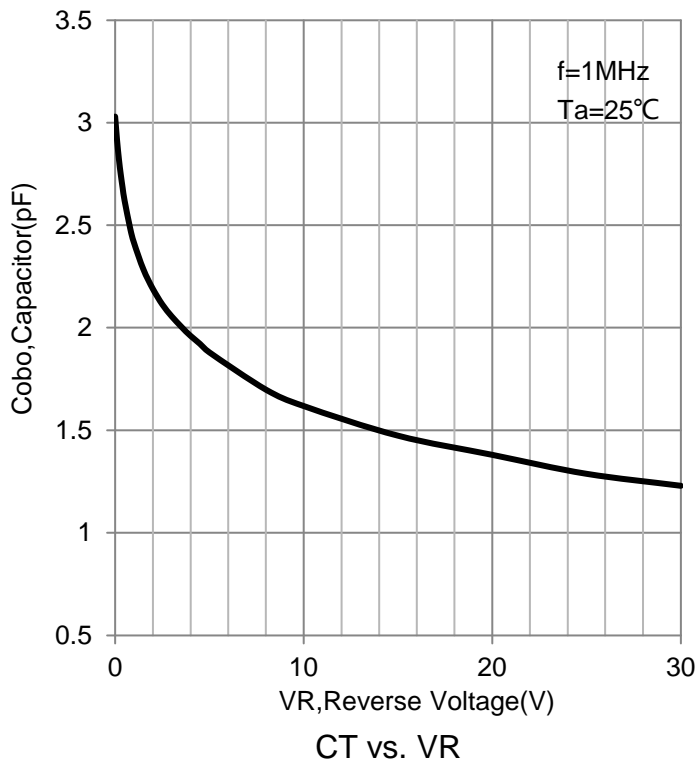
6.ELECTRICAL CHARACTERISTICS CURVES(Con.)

7.OUTLINE AND DIMENSIONS

Notes:

1. DIMENSIONING AND TOLERANCING PER ANSI Y14.5M, 1982.
2. CONTROLLING DIMENSION: MILLIMETERS.
3. MAXIMUM LEAD THICKNESS INCLUDES LEAD FINISH. MINIMUM LEAD THICKNESS IS THE MINIMUM THICKNESS OF BASE MATERIAL.
4. DIMENSIONS D AND E DO NOT INCLUDE MOLD FLASH, PROTRUSIONS OR GATE BURRS.

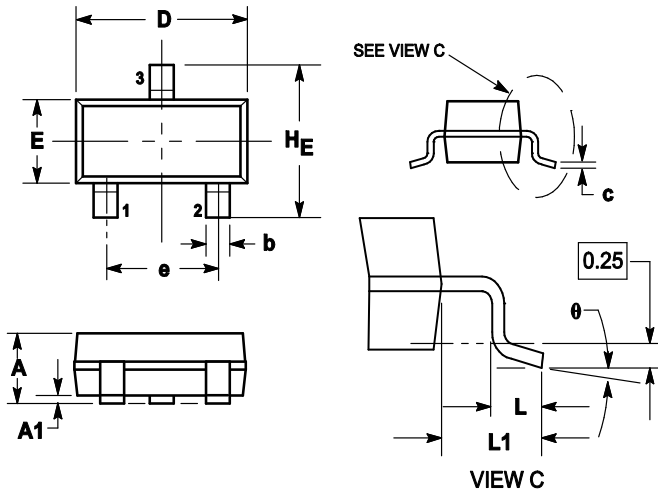

DIM	MILLIMETERS			INCHES		
	MIN	NOM	MAX	MIN	NOM	MAX
A	0.89	1	1.11	0.035	0.04	0.044
A1	0.01	0.06	0.1	0.001	0.002	0.004
b	0.37	0.44	0.5	0.015	0.018	0.02
c	0.09	0.13	0.18	0.003	0.005	0.007
D	2.80	2.9	3.04	0.11	0.114	0.12
E	1.20	1.3	1.4	0.047	0.051	0.055
e	1.78	1.9	2.04	0.07	0.075	0.081
L	0.10	0.2	0.3	0.004	0.008	0.012
L1	0.35	0.54	0.69	0.014	0.021	0.029
HE	2.10	2.4	2.64	0.083	0.094	0.104
θ	0°	---	10°	0°	---	10°

8.SOLDERING FOOTPRINT
