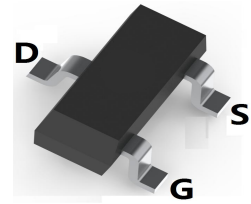
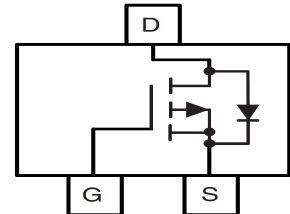

LOW VOLTAGE MOSFET (P-CHANNEL)
FEATURES

- $V_{DS}=-30V, R_{DS(ON)} \leq 52m\Omega @ V_{GS}=-10V, I_D=-4.1A$
- Low on-resistance
- For PWM and Load switch applications
- Surface Mount device

SOT-23

MECHANICAL DATA

- Case: SOT-23
- Case Material: Molded Plastic. UL flammability
- Classification Rating: 94V-0
- Weight: 0.008 grams (approximate)

MAXIMUM RATINGS ($T_A = 25^\circ C$ unless otherwise noted)

Parameter	Symbol	Value	Unit	
Drain-source voltage	V_{DS}	-30	V	
Gate-source voltage	V_{GS}	± 20	V	
Continuous drain current	I_D	$T_A=25^\circ C$	-4.1	A
		$T_A=70^\circ C$	-3.5	A
Pulsed drain current	I_{DM}	-25	A	
Power dissipation	P_D	$T_A=25^\circ C$	1.4	W
		$T_A=70^\circ C$	0.9	W
Thermal resistance from Junction to ambient	$R_{\theta JA}$	125	$^\circ C/W$	
Junction temperature	T_J	150	$^\circ C$	
Storage temperature	T_{STG}	-55~+150	$^\circ C$	

ELECTRICAL CHARACTERISTICS ($T_A = 25^\circ C$ unless otherwise specified)

Parameter	Symbol	Min	Typ	Max	Unit	Conditions
Drain-Source breakdown voltage	$V_{(BR)DSS}^*$	-30			V	$V_{GS}=0V, I_D=-250\mu A$
Zero gate voltage drain current	I_{DSS}^*			-1	μA	$V_{DS}=-30V, V_{GS}=0V$
Gate-body leakage current	I_{GSS}^*			± 100	nA	$V_{DS}=0V, V_{GS}=\pm 20V$
Gate-threshold voltage	$V_{GS(th)}^*$	-1.1	-1.4	-2.1	V	$V_{DS}=V_{GS}, I_D=-250\mu A$
On state drain current	$I_{D(ON)}^*$	-25			A	$V_{GS}=-10V, V_{DS}=-5V$
Drain-source on-resistance	$R_{DS(ON)}^*$		40	55	m Ω	$V_{GS}=-10V, I_D=-4.1A$
			52	73	m Ω	$V_{GS}=-10V, I_D=-4.1A, T_J=125^\circ C$
			54	87	m Ω	$V_{GS}=-4.5V, I_D=-3A$
Forward transconductance	g_{FS}		10		S	$V_{DS}=-5V, I_D=-4.1A$
Gate resistance	R_g	3.5	7.5	11.5	Ω	$V_{DS}=0V, V_{GS}=0V, f=1MHz$
Input capacitance	C_{iss}		520		pF	$V_{DS}=-15V, V_{GS}=0V, f=1MHz$
Output capacitance	C_{oss}		100		pF	
Reverse transfer capacitance	C_{rss}		65		pF	
Turn-on delay time	$t_{d(on)}$		7.5		nS	$V_{GS}=-10V, V_{DS}=-15V, R_{GEN}=3\Omega, R_L=3.65\Omega$
Turn-on rise time	t_r		5.5		nS	
Turn-off delay time	$t_{d(off)}$		19		nS	
Turn-off fall time	t_f		7		nS	
Total gate charge	Q_g		4.6	6	nC	$V_{DS}=-15V, V_{GS}=-4.5V, I_D=-4.1A$
			9.2	11	nC	
Gate-source charge	Q_{gs}		1.6		nC	$V_{DS}=-15V, V_{GS}=-10V, I_D=-4.1A$
Gate-drain charge	Q_{gd}		2.2		nC	
Diode forward voltage	V_{SD}		-0.7	-1	V	$I_S=-1A, V_{GS}=0V$
Diode forward current	I_S			-2	A	
Body Diode Reverse Recovery Time	t_{rr}		11		nS	$I_F=-4.1A, dI/dt=100A/\mu s$
Body Diode Reverse Recovery Charge	Q_{rr}		5.3		nC	

* Pulse test ; Pulse width $\leq 300\mu s$, Duty cycle $\leq 0.5\%$.

LOW VOLTAGE MOSFET (P-CHANNEL)

Typical Characteristics

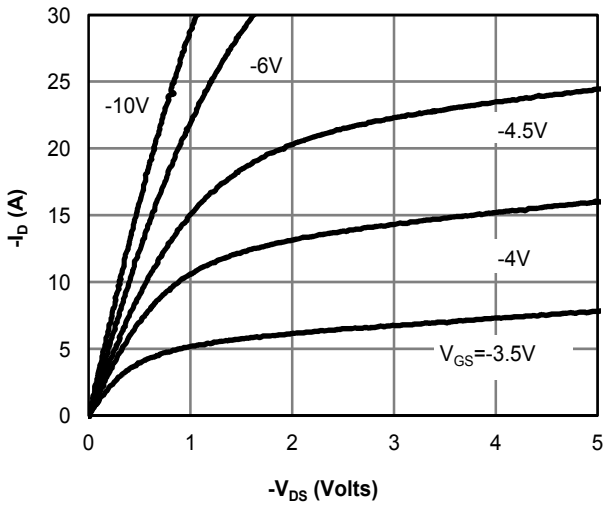

Fig 1: On-Region Characteristics

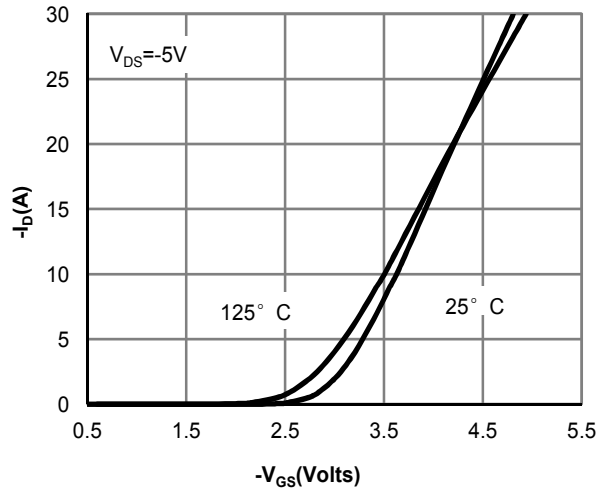

Figure 2: Transfer Characteristics

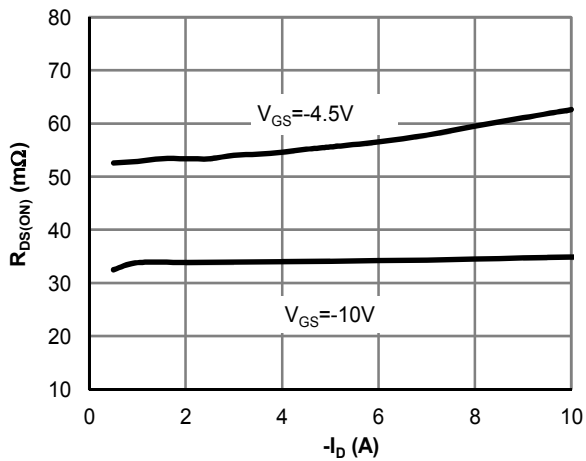

Figure 3: On-Resistance vs. Drain Current and Gate Voltage

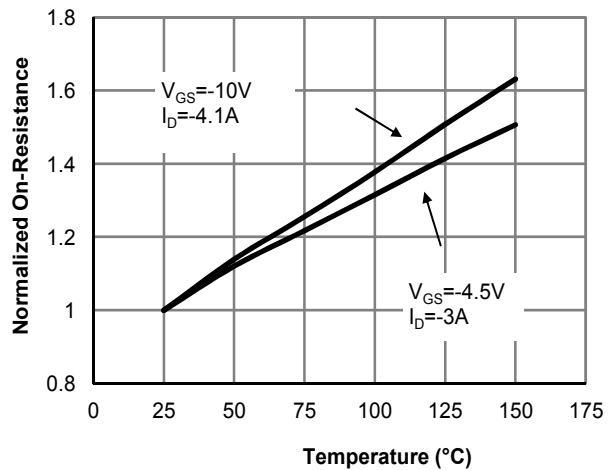

Figure 4: On-Resistance vs. Junction Temperature

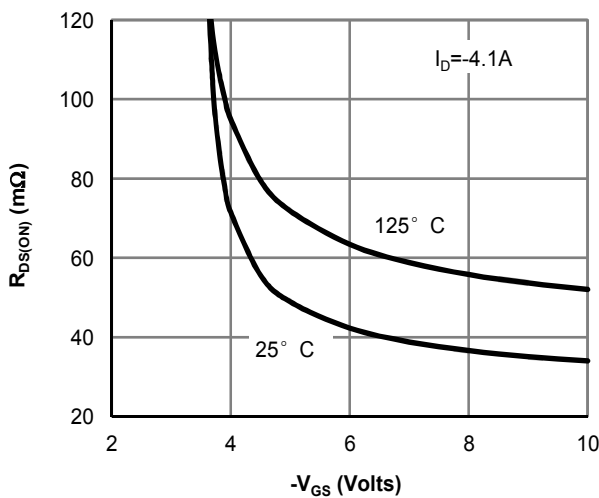

Figure 5: On-Resistance vs. Gate-Source Voltage

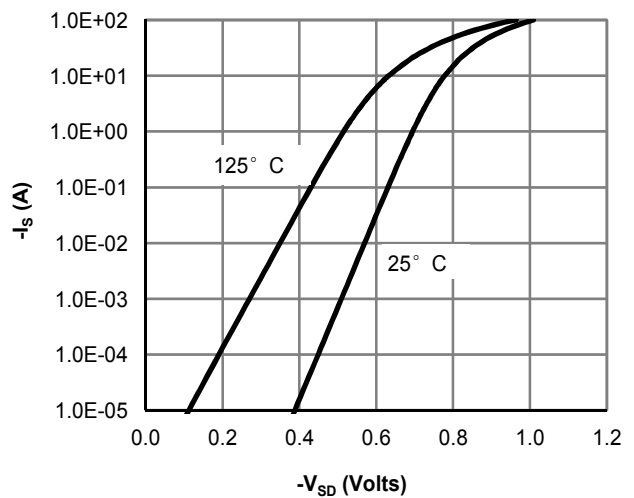

Figure 6: Body-Diode Characteristics

LOW VOLTAGE MOSFET (P-CHANNEL)

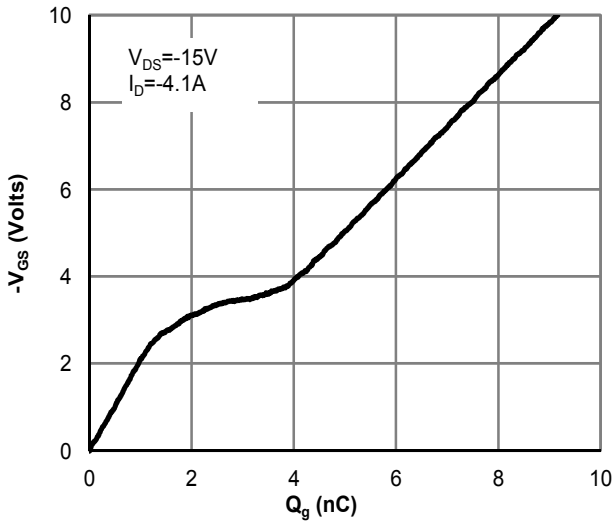

Figure 7: Gate-Charge Characteristics

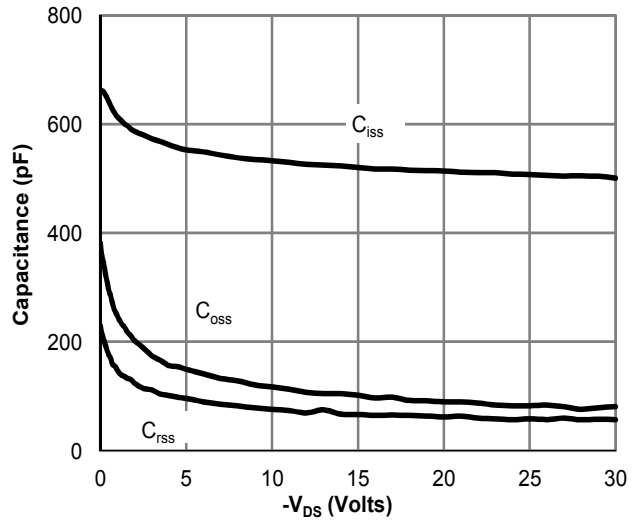

Figure 8: Capacitance Characteristics

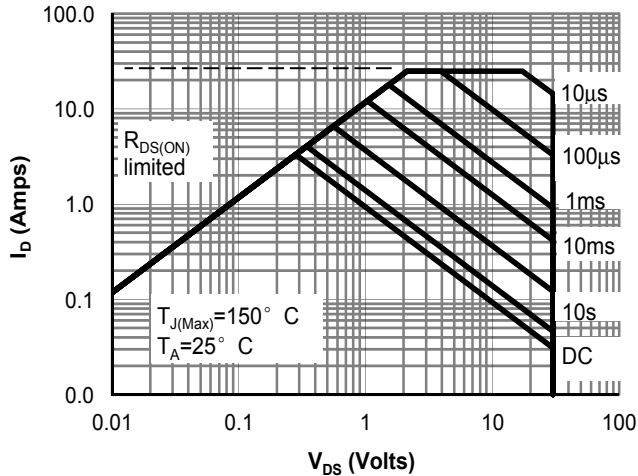

Figure 9: Maximum Forward Biased Safe Operating Area

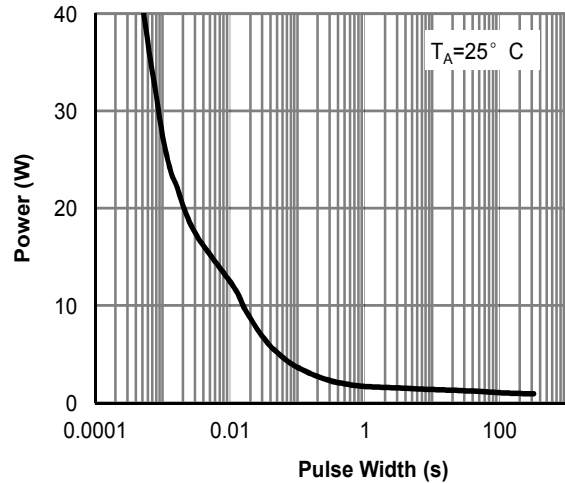

Figure 10: Single Pulse Power Rating Junction-to-Ambient

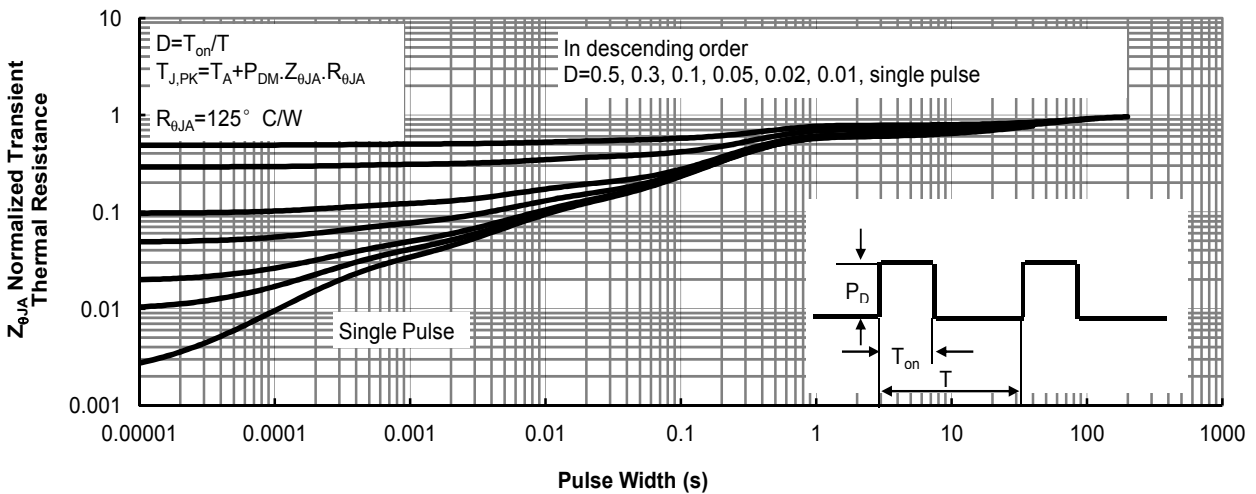
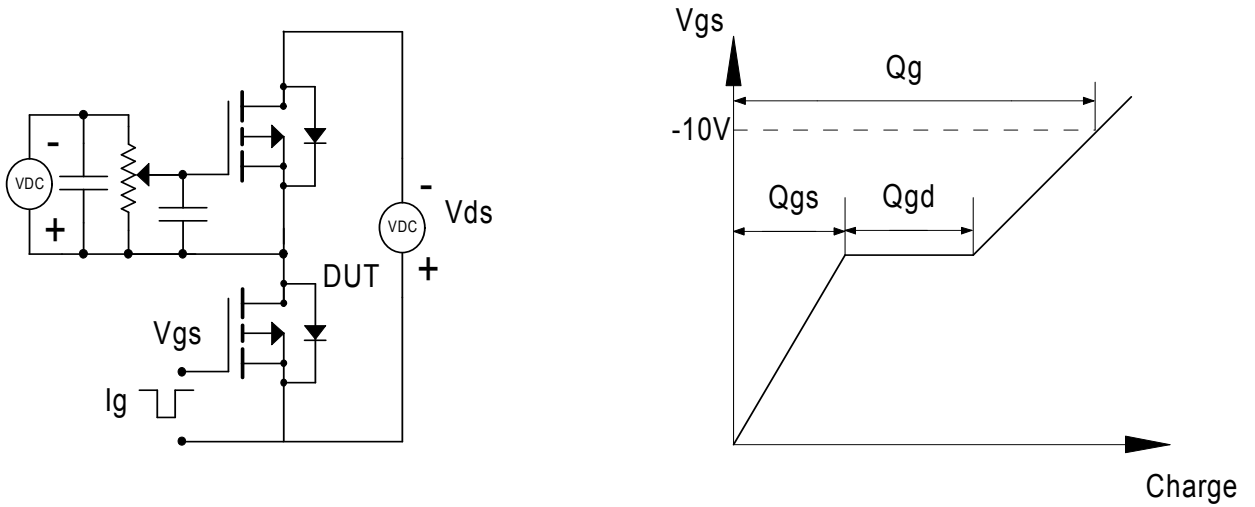

Figure 11: Normalized Maximum Transient Thermal Impedance

LOW VOLTAGE MOSFET (P-CHANNEL)

Gate Charge Test Circuit & Waveform



Resistive Switching Test Circuit & Waveforms

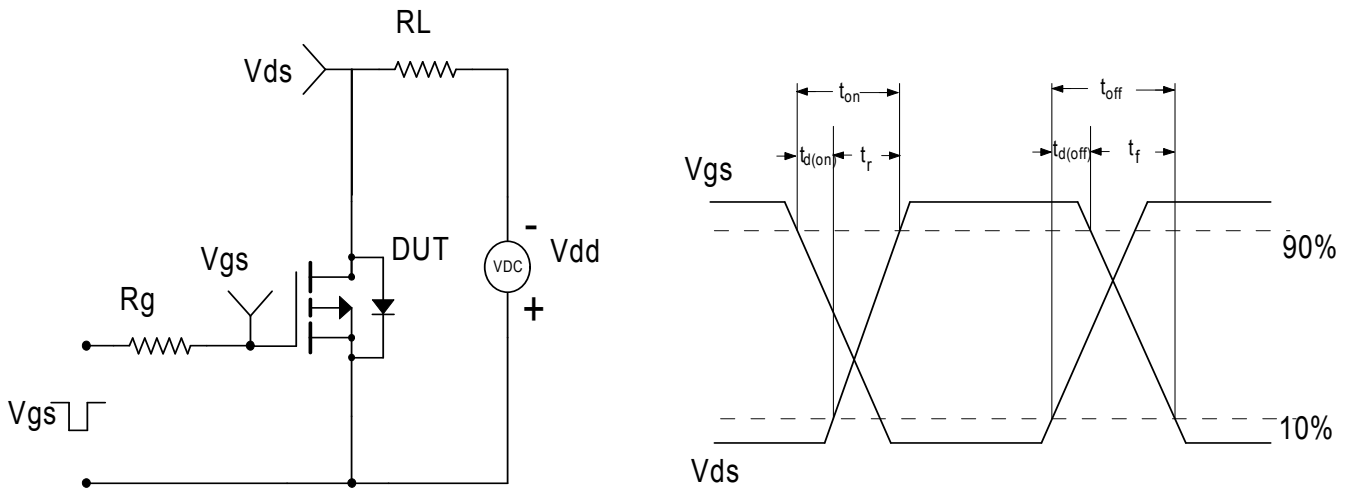

Diode Recovery Test Circuit & Waveforms

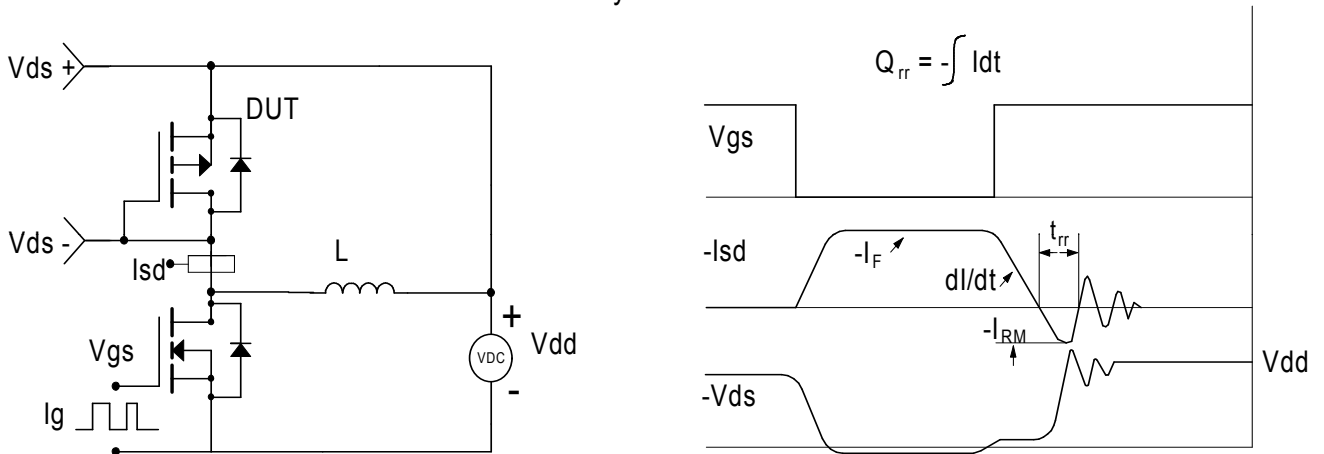

LOW VOLTAGE MOSFET (P-CHANNEL)

SOT-23 Package Outline Dimensions

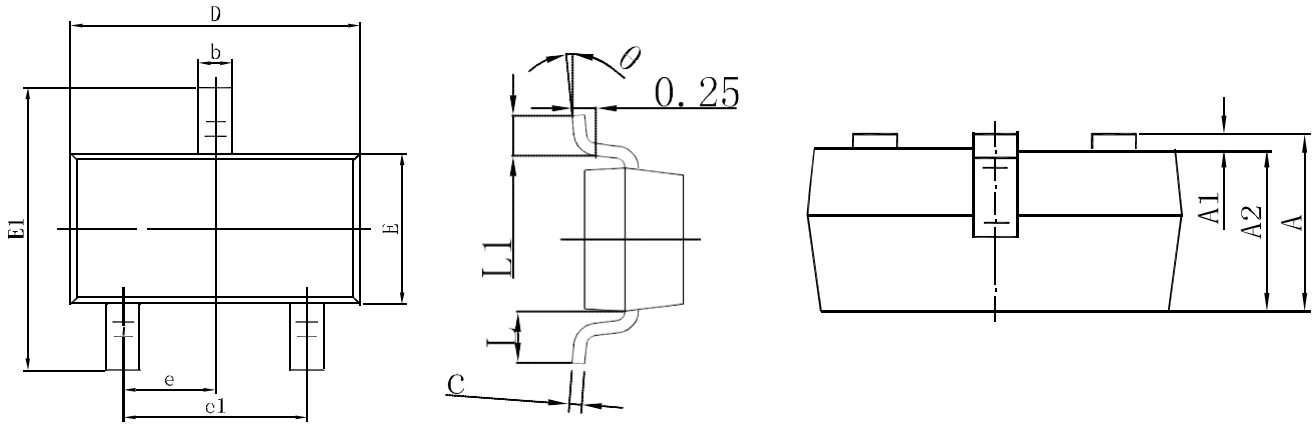

Symbol	Dimensions In Millimeters		Dimensions In Inches	
	Min.	Max.	Min.	Max.
A	0.900	1.150	0.035	0.045
A1	0.000	0.100	0.000	0.004
A2	0.900	1.050	0.035	0.041
b	0.300	0.500	0.012	0.020
c	0.080	0.150	0.003	0.006
D	2.800	3.000	0.110	0.118
E	1.200	1.400	0.047	0.055
E1	2.250	2.550	0.089	0.100
e	0.950 TYP		0.037 TYP	
e1	1.800	2.000	0.071	0.079
L	0.550 REF		0.022 REF	
L1	0.300	0.500	0.012	0.020
θ	0°	8°	0°	8°

SOT-23 Suggested Pad Layout

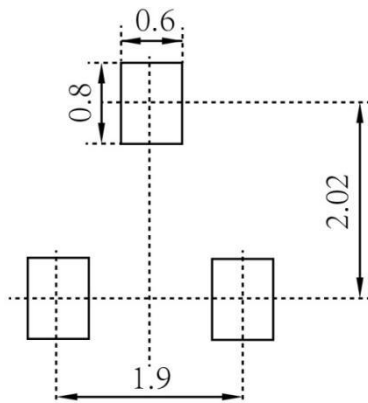

Note:

1. Controlling dimension: in millimeters
2. General tolerance: $\pm 0.05\text{mm}$
3. The pad layout is for reference purposes only

LOW VOLTAGE MOSFET (P-CHANNEL)

SOT-23 Tape and Reel

SOT-23 Embossed Carrier Tape

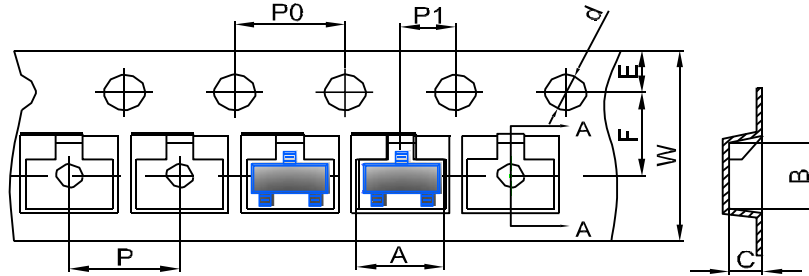

DIMENSIONS ARE IN MILLIMETER										
TYPE	A	B	C	d	E	F	P0	P	P1	W
SOT-23	3.15	2.77	1.22	Ø1.50	1.75	3.50	4.00	4.00	2.00	8.00
TOLERANCE	±0.1	±0.1	±0.1	±0.1	±0.1	±0.1	±0.1	±0.1	±0.1	±0.1

SOT-23 Tape Leader and Trailer

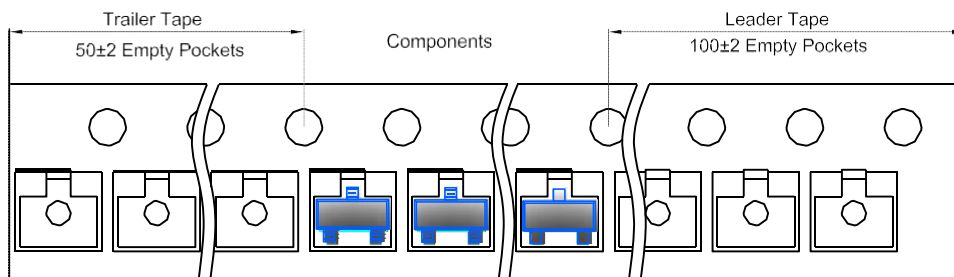

SOT-23 Reel

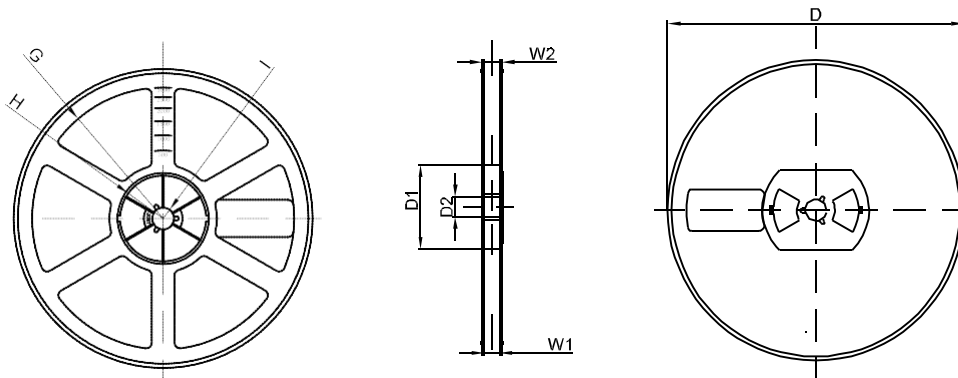

DIMENSIONS ARE IN MILLIMETER								
REEL OPTION	D	D1	D2	G	H	I	W1	W2
7" DIA	Ø178	54.40	13.00	R78	R25.60	R6.50	9.50	12.30
TOLERANCE	±2	±1	±1	±1	±1	±1	±1	±1