



SGM8968-1/SGM8968-2/SGM8968-4

1.6mA, 10MHz, High Precision, Low Noise, Rail-to-Rail I/O, CMOS Operational Amplifiers

GENERAL DESCRIPTION

The SGM8968-1/2/4 are a family of single, dual and quad rail-to-rail input and output operational amplifiers, which are optimized for low voltage, low noise and high precision operation. These devices can operate from 1.8V to 5.5V single supply, while consuming only 1.6mA quiescent current per amplifier at 5.5V.

The SGM8968-1/2/4 feature a 240 μ V maximum input offset. They exhibit a high gain-bandwidth product of 10MHz and a slew rate of 20V/ μ s. These specifications make the operational amplifiers appropriate for various applications.

The SGM8968-1 is available in Green SOT-23-5 and SOIC-8 packages. The SGM8968-2 is available in Green SOIC-8 and MSOP-8 packages. The SGM8968-4 is available in Green SOIC-14 and TSSOP-14 packages. They are specified over the extended industrial temperature range (-40°C to +125°C).

FEATURES

- **Input Offset Voltage: 240 μ V (MAX)**
- **High Gain-Bandwidth Product: 10MHz**
- **High Slew Rate: 20V/ μ s**
- **Settling Time to 0.1% with 2V Step: 280ns**
- **Overload Recovery Time: 100ns**
- **Low Noise: 8nV/ $\sqrt{\text{Hz}}$ at 10kHz**
- **Rail-to-Rail Input and Output**
- **Supply Voltage Range: 1.8V to 5.5V**
- **Input Voltage Range: -0.1V to 5.6V with $V_S = 5.5V$**
- **Low Power: 1.6mA/Amplifier (TYP) Supply Current**
- **-40°C to +125°C Operating Temperature Range**
- **Small Packaging:**
 - SGM8968-1 Available in Green SOT-23-5 and SOIC-8 Packages**
 - SGM8968-2 Available in Green SOIC-8 and MSOP-8 Packages**
 - SGM8968-4 Available in Green SOIC-14 and TSSOP-14 Packages**

APPLICATIONS

Sensor
Audio
Active Filter
A/D Converter
Communication
Test Equipment
Cellular and Cordless Phone
Laptop and PDA
Photodiode Amplification
Battery-Powered Instrumentation

PACKAGE/ORDERING INFORMATION

MODEL	PACKAGE DESCRIPTION	SPECIFIED TEMPERATURE RANGE	ORDERING NUMBER	PACKAGE MARKING	PACKING OPTION
SGM8968-1	SOT-23-5	-40°C to +125°C	SGM8968-1XN5G/TR	MB6XX	Tape and Reel, 3000
	SOIC-8	-40°C to +125°C	SGM8968-1XS8G/TR	SGM 89681XS8 XXXXX	Tape and Reel, 4000
SGM8968-2	SOIC-8	-40°C to +125°C	SGM8968-2XS8G/TR	SGM 89682XS8 XXXXX	Tape and Reel, 4000
	MSOP-8	-40°C to +125°C	SGM8968-2XMS8G/TR	SGM89682 XMS8 XXXXX	Tape and Reel, 4000
SGM8968-4	SOIC-14	-40°C to +125°C	SGM8968-4XS14G/TR	SGM89684XS14 XXXXX	Tape and Reel, 2500
	TSSOP-14	-40°C to +125°C	SGM8968-4XTS14G/TR	SGM89684 XTS14 XXXXX	Tape and Reel, 4000

MARKING INFORMATION

NOTE: XX = Date Code. XXXXX = Date Code, Trace Code and Vendor Code.

SOT-23-5

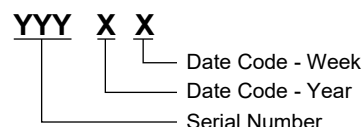

SOIC-8/MSOP-8/SOIC-14/TSSOP-14

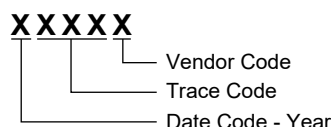

Green (RoHS & HSF): SG Micro Corp defines "Green" to mean Pb-Free (RoHS compatible) and free of halogen substances. If you have additional comments or questions, please contact your SGMICRO representative directly.

ABSOLUTE MAXIMUM RATINGS

- Supply Voltage, +Vs to -Vs.....6V
- Input Common Mode Voltage Range
..... (-Vs) - 0.3V to (+Vs) + 0.3V
- Junction Temperature+150°C
- Storage Temperature Range.....-65°C to +150°C
- Lead Temperature (Soldering, 10s)+260°C
- ESD Susceptibility
- HBM (SGM8968-1/2) 7000V
- HBM (SGM8968-4) 6000V
- CDM 1000V

RECOMMENDED OPERATING CONDITIONS

- Operating Temperature Range-40°C to +125°C

OVERSTRESS CAUTION

Stresses beyond those listed in Absolute Maximum Ratings may cause permanent damage to the device. Exposure to absolute maximum rating conditions for extended periods

may affect reliability. Functional operation of the device at any conditions beyond those indicated in the Recommended Operating Conditions section is not implied.

ESD SENSITIVITY CAUTION

This integrated circuit can be damaged if ESD protections are not considered carefully. SGMICRO recommends that all integrated circuits be handled with appropriate precautions. Failure to observe proper handling and installation procedures can cause damage. ESD damage can range from subtle performance degradation to complete device failure. Precision integrated circuits may be more susceptible to damage because even small parametric changes could cause the device not to meet the published specifications.

DISCLAIMER

SG Micro Corp reserves the right to make any change in circuit design, or specifications without prior notice.

PIN CONFIGURATIONS

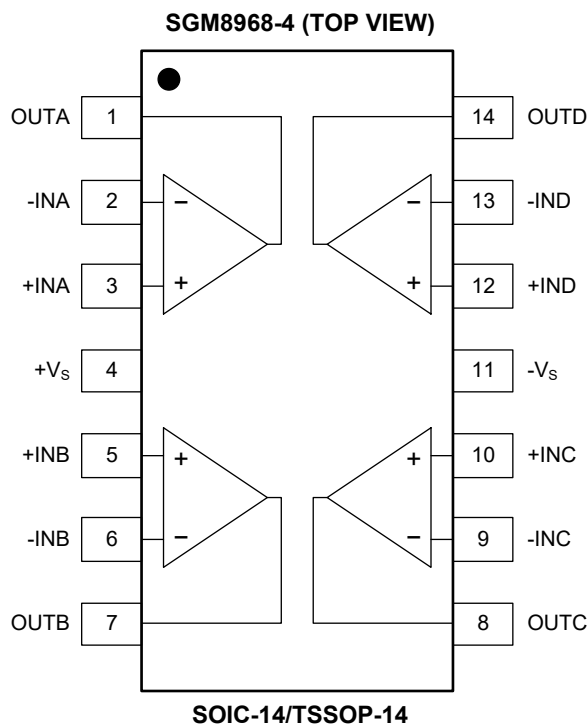
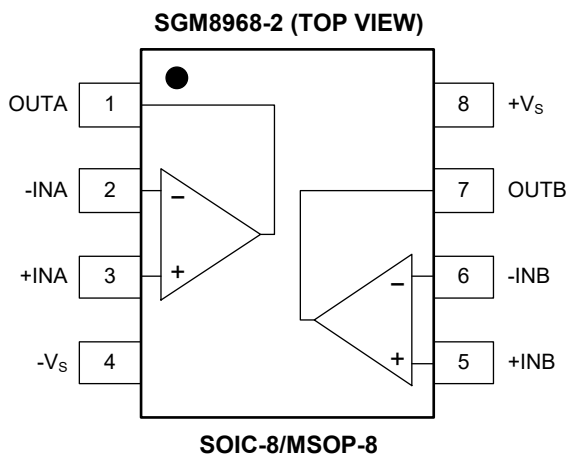
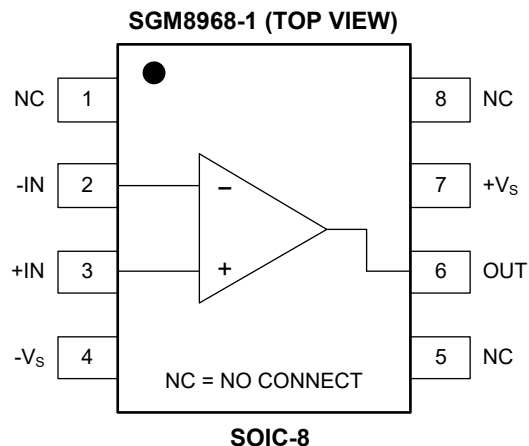
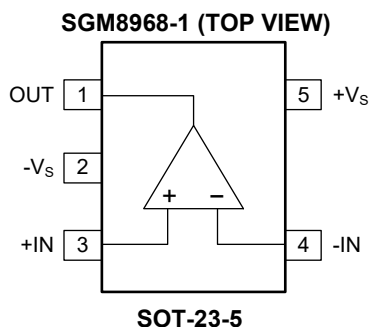

ELECTRICAL CHARACTERISTICS

(At $T_A = +25^\circ\text{C}$, $V_S = 1.8\text{V}$ to 5.5V or $\pm 0.9\text{V}$ to $\pm 2.75\text{V}$, $V_{CM} = V_S/2$ and $R_L = 10\text{k}\Omega$ connected to $V_S/2$, Full = -40°C to $+125^\circ\text{C}$, unless otherwise noted.)

PARAMETER	SYMBOL	CONDITIONS	TEMP	MIN	TYP	MAX	UNITS
Input Characteristics							
Input Offset Voltage	V_{OS}		+25°C		50	240	μV
			Full			700	
Input Offset Voltage Drift	$\Delta V_{OS}/\Delta T$	$V_S = \pm 2.75\text{V}$	Full		1		$\mu\text{V}/^\circ\text{C}$
Input Bias Current	I_B		+25°C		6	120	pA
			Full			6500	
Input Offset Current	I_{OS}		+25°C		6	120	pA
			Full			1500	
Input Common Mode Voltage Range	V_{CM}		Full	$(-V_S) - 0.1$		$(+V_S) + 0.1$	V
Common Mode Rejection Ratio	CMRR	$V_S = 5.5\text{V}$, $V_{CM} = -0.1\text{V}$ to 5.6V	+25°C	84	95		dB
			Full	81			
		$V_S = 1.8\text{V}$, $V_{CM} = -0.1\text{V}$ to 1.9V	+25°C	75	94		
			Full	71			
Open-Loop Voltage Gain	A_{OL}	$V_S = \pm 0.9\text{V}$, $R_L = 1\text{k}\Omega$, $(-V_S) + 0.25\text{V} < V_{OUT} < (+V_S) - 0.25\text{V}$	+25°C	90	117		dB
			Full	87			
		$V_S = \pm 2.75\text{V}$, $R_L = 1\text{k}\Omega$, $(-V_S) + 0.25\text{V} < V_{OUT} < (+V_S) - 0.25\text{V}$	+25°C	102	130		
			Full	99			
		$V_S = \pm 0.9\text{V}$, $R_L = 10\text{k}\Omega$, $(-V_S) + 0.15\text{V} < V_{OUT} < (+V_S) - 0.15\text{V}$	+25°C	93	117		
			Full	90			
		$V_S = \pm 2.75\text{V}$, $R_L = 10\text{k}\Omega$, $(-V_S) + 0.15\text{V} < V_{OUT} < (+V_S) - 0.15\text{V}$	+25°C	102	128		
			Full	99			
Output Characteristics							
Output Voltage Swing from Rail	V_{OUT}	$V_S = 5.5\text{V}$, $R_L = 1\text{k}\Omega$	+25°C		60	80	mV
			Full			88	
		$V_S = 5.5\text{V}$, $R_L = 10\text{k}\Omega$	+25°C		8	13	
			Full			15	
Output Current (I_{OUT})	I_{OUT}	$V_S = 5.5\text{V}$	+25°C	31	80		mA
			Full	19			
Power Supply							
Operating Voltage Range	V_S		Full	1.8		5.5	V
Power Supply Rejection Ratio	PSRR	$V_S = 1.8\text{V}$ to 5.5V , $V_{CM} = (-V_S) + 0.5\text{V}$	+25°C	89	110		dB
			Full	86			
Quiescent Current/Amplifier	I_Q	$I_{OUT} = 0$	+25°C		1.6	2.1	mA
			Full			2.2	
Dynamic Performance							
Gain-Bandwidth Product	GBP	$V_S = 5\text{V}$	+25°C		10		MHz
Phase Margin	ϕ_O	$V_S = 5\text{V}$	+25°C		60		°
Slew Rate	SR	$V_S = 5\text{V}$, $G = +1$, 2V output step	+25°C		20		V/ μs
Settling Time to 0.1%	t_S	$V_S = 5\text{V}$, $G = +1$, 2V output step	+25°C		280		ns
Overload Recovery Time		$V_S = 5\text{V}$, $V_{IN} \times G = V_S$	+25°C		100		ns
Total Harmonic Distortion + Noise	THD+N	$V_{OUT} = 4V_{P-P}$, $G = +1$, $f = 10\text{kHz}$, $BW = 22\text{Hz}$ to 80kHz	+25°C		0.0005		%
Noise Performance							
Input Voltage Noise Density	e_n	$f = 1\text{kHz}$	+25°C		18		$\text{nV}/\sqrt{\text{Hz}}$
		$f = 10\text{kHz}$	+25°C		8		

TYPICAL PERFORMANCE CHARACTERISTICS

At $T_A = +25^\circ\text{C}$, $V_S = \pm 2.75\text{V}$ and $R_L = 10\text{k}\Omega$, unless otherwise noted.

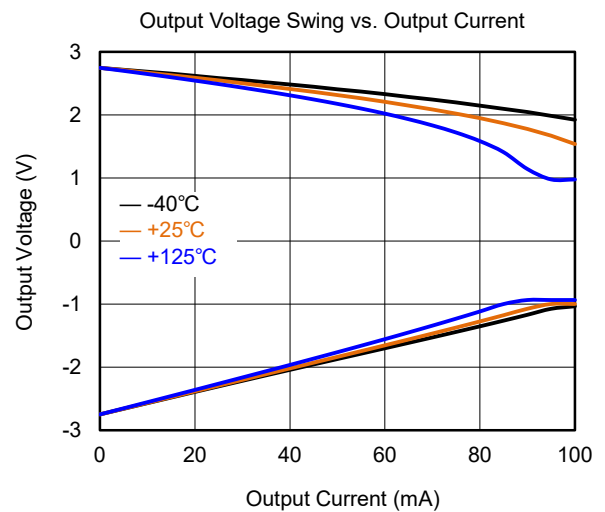
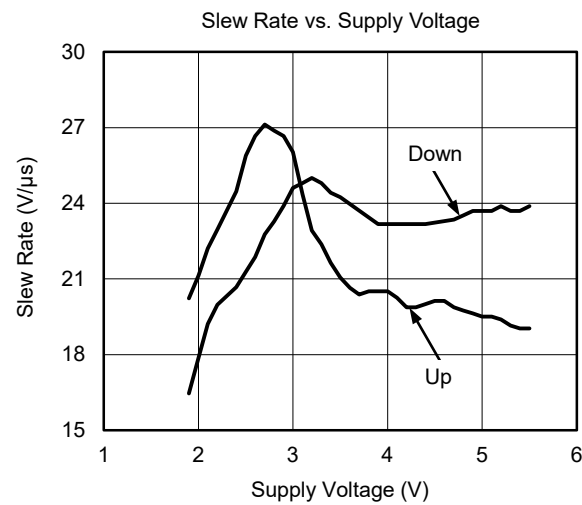
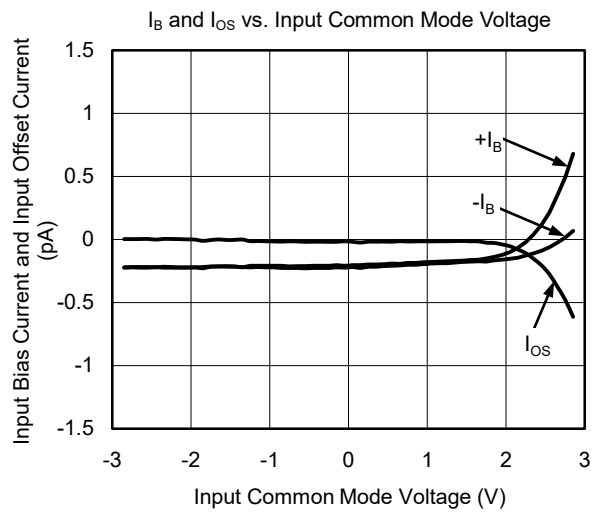
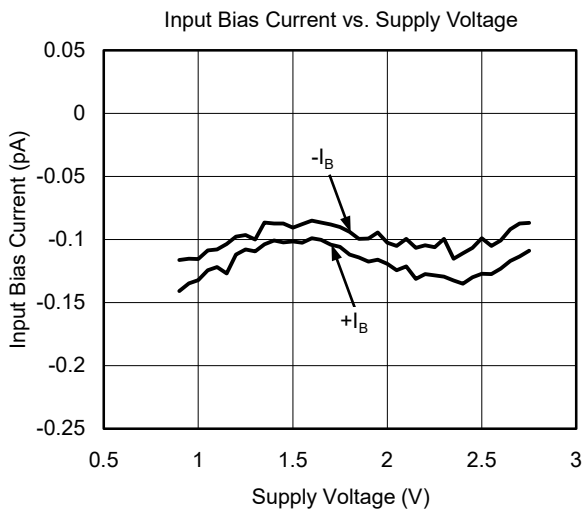
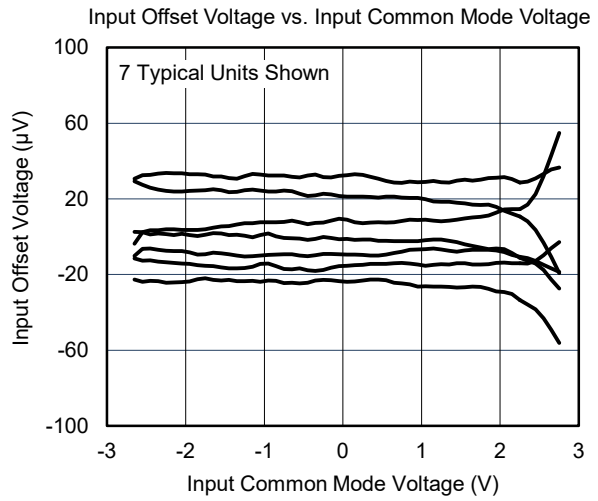
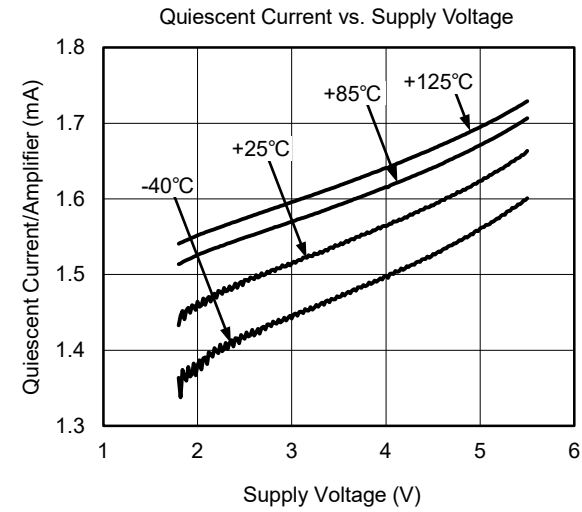

TYPICAL PERFORMANCE CHARACTERISTICS (continued)

At $T_A = +25^\circ\text{C}$, $V_S = \pm 2.75\text{V}$ and $R_L = 10\text{k}\Omega$, unless otherwise noted.

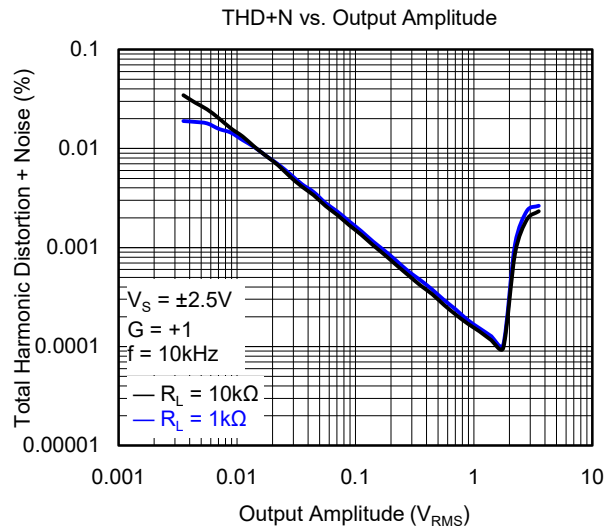
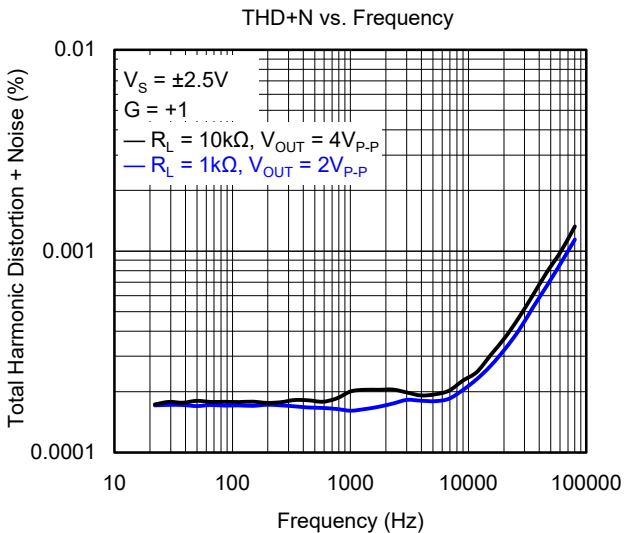
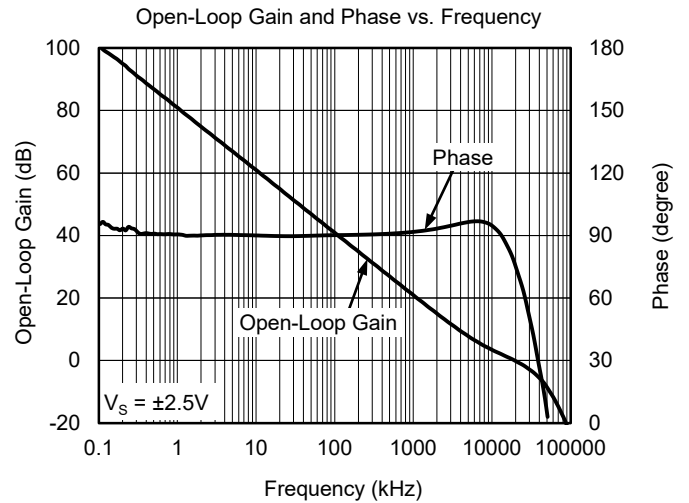
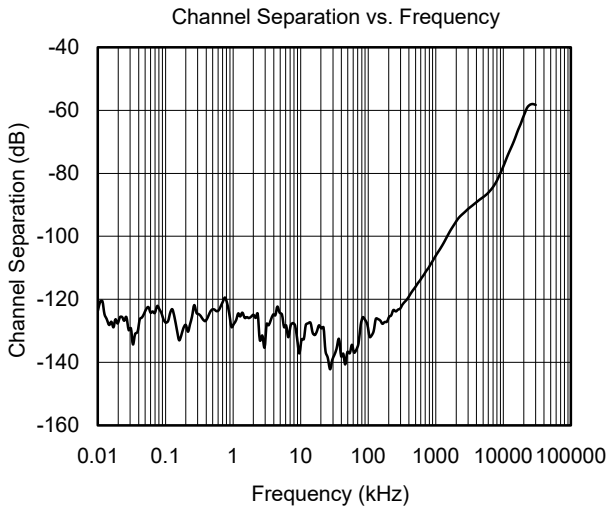
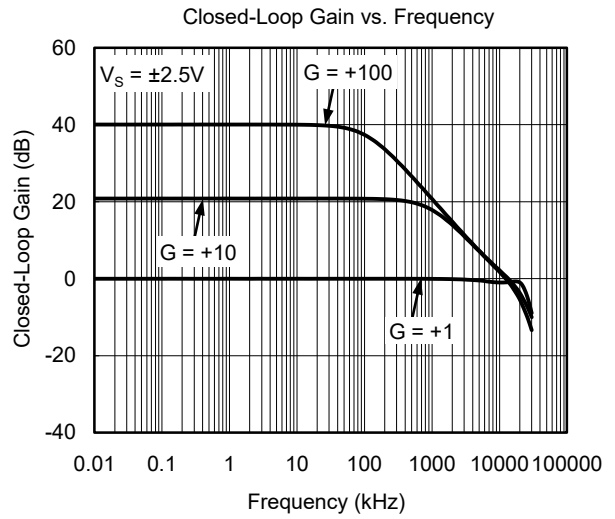
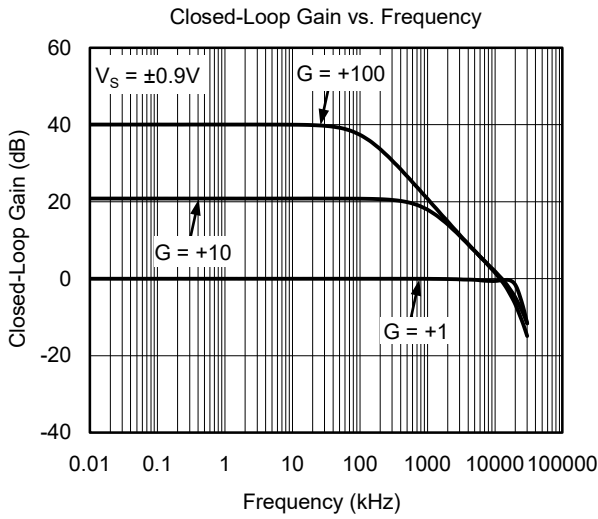

TYPICAL PERFORMANCE CHARACTERISTICS (continued)

At $T_A = +25^\circ\text{C}$, $V_S = \pm 2.75\text{V}$ and $R_L = 10\text{k}\Omega$, unless otherwise noted.

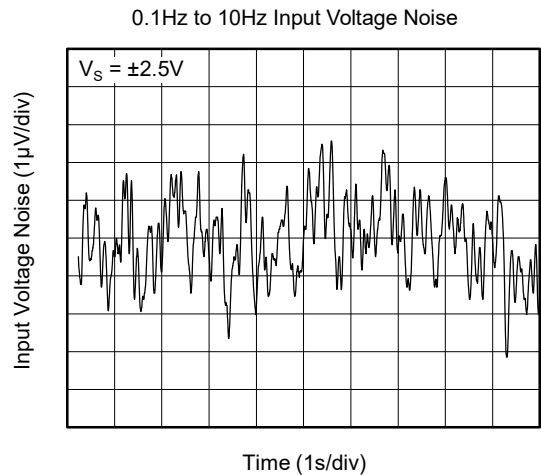
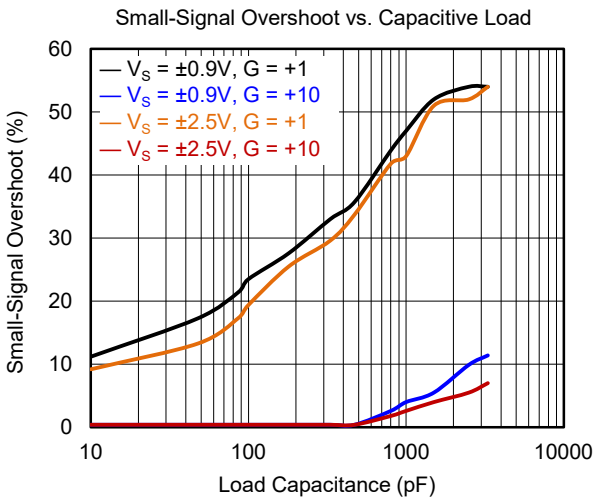
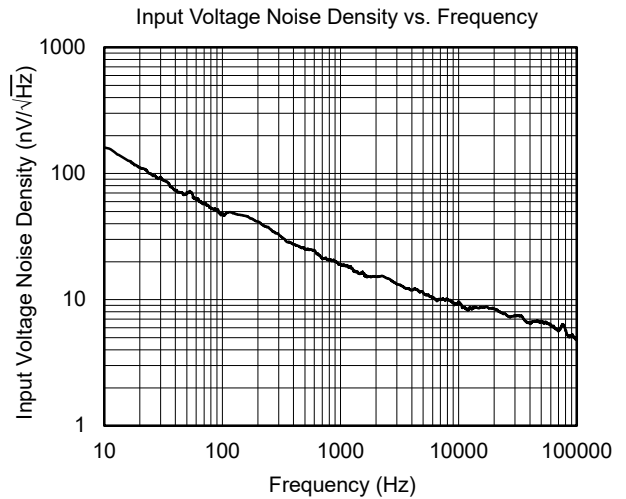
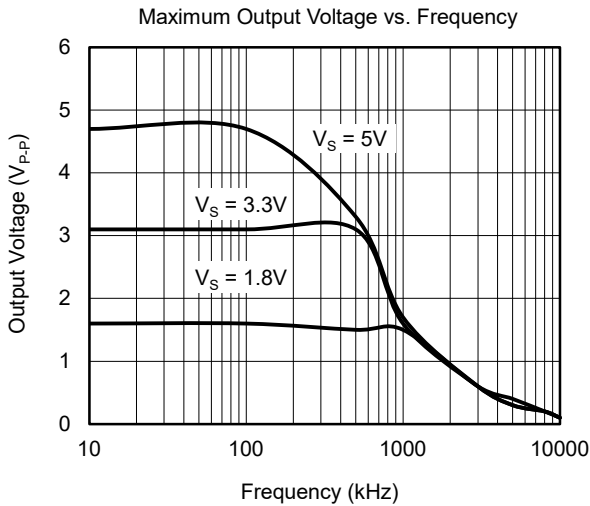
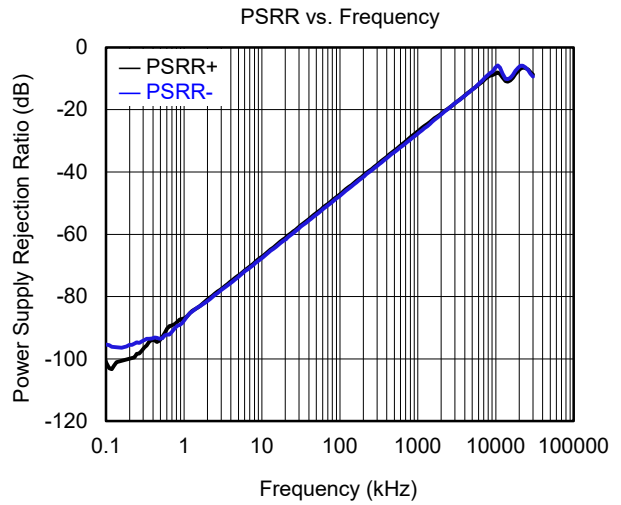
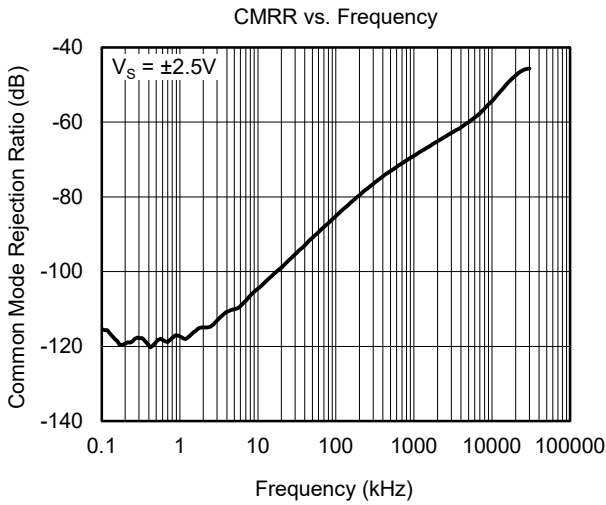

TYPICAL PERFORMANCE CHARACTERISTICS (continued)

At $T_A = +25^\circ\text{C}$, $V_S = \pm 2.75\text{V}$ and $R_L = 10\text{k}\Omega$, unless otherwise noted.

Small-Signal Step Response

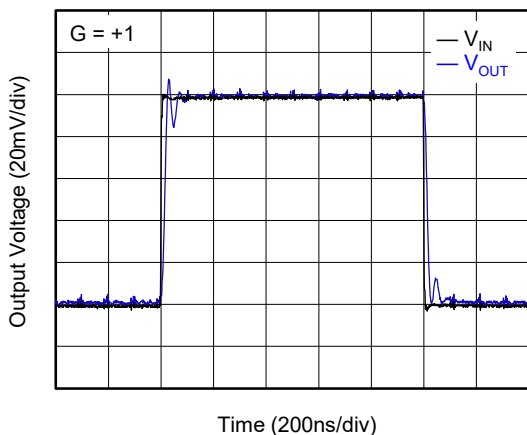

Small-Signal Step Response

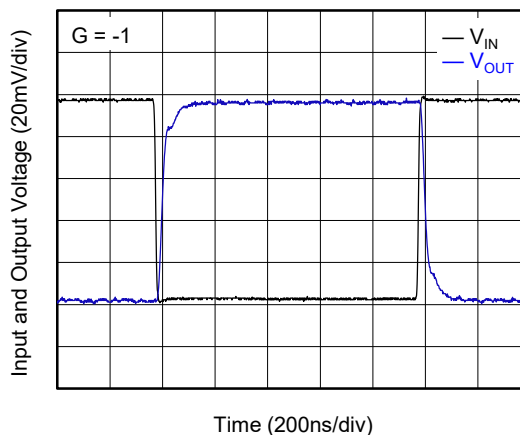

Large-Signal Step Response

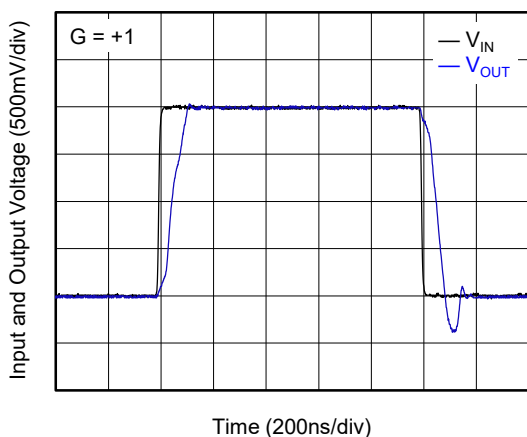

No Phase Reversal

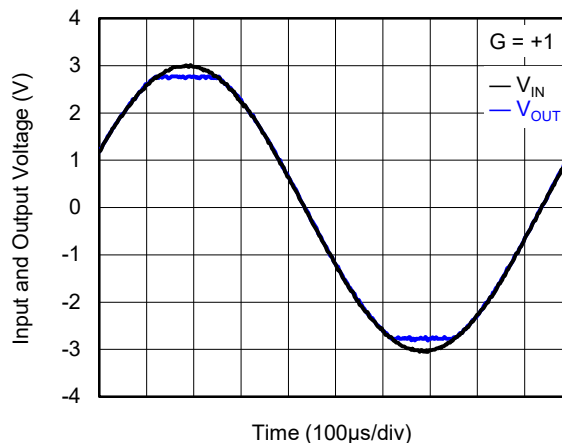

Input Offset Voltage Production Distribution

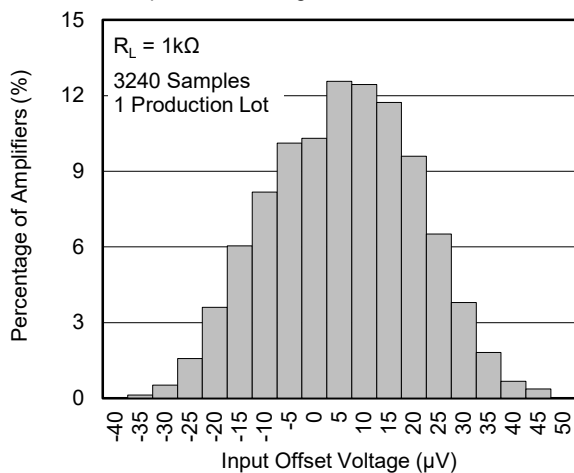

Input Offset Voltage Drift Distribution

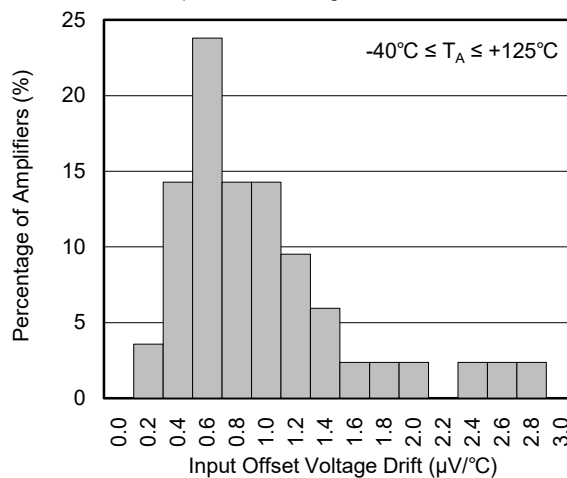

REVISION HISTORY

NOTE: Page numbers for previous revisions may differ from page numbers in the current version.

MAY 2020 – REV.A to REV.A.1	Page
Updated Electrical Characteristics section	4
Updated Typical Performance Characteristics section	8

Changes from Original (DECEMBER 2019) to REV.A	Page
Changed from product preview to production data.....	All

PACKAGE OUTLINE DIMENSIONS

SOT-23-5

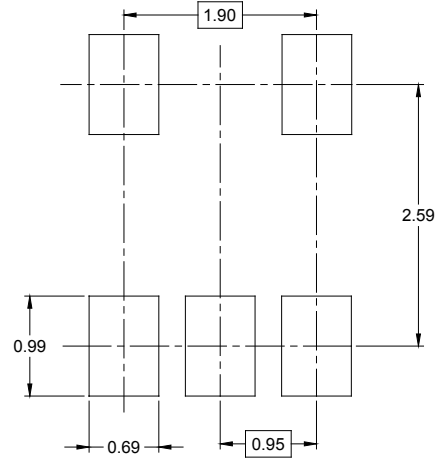
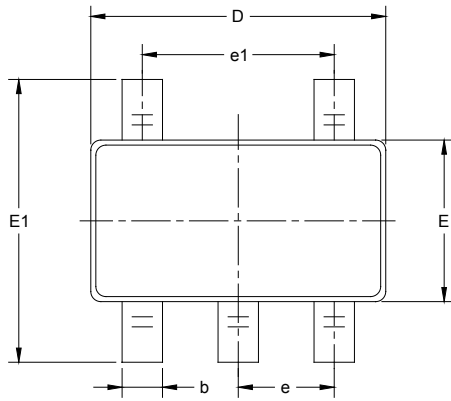

RECOMMENDED LAND PATTERN (Unit: mm)

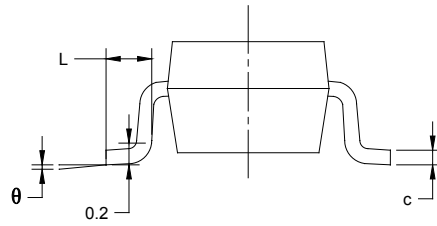
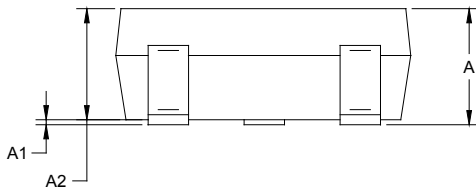

Symbol	Dimensions In Millimeters		Dimensions In Inches	
	MIN	MAX	MIN	MAX
A	1.050	1.250	0.041	0.049
A1	0.000	0.100	0.000	0.004
A2	1.050	1.150	0.041	0.045
b	0.300	0.500	0.012	0.020
c	0.100	0.200	0.004	0.008
D	2.820	3.020	0.111	0.119
E	1.500	1.700	0.059	0.067
E1	2.650	2.950	0.104	0.116
e	0.950 BSC		0.037 BSC	
e1	1.900 BSC		0.075 BSC	
L	0.300	0.600	0.012	0.024
θ	0°	8°	0°	8°

PACKAGE OUTLINE DIMENSIONS

SOIC-8

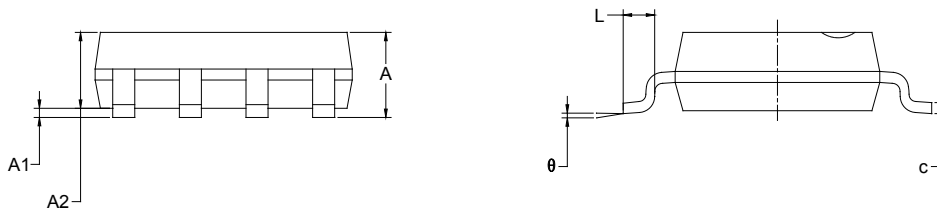
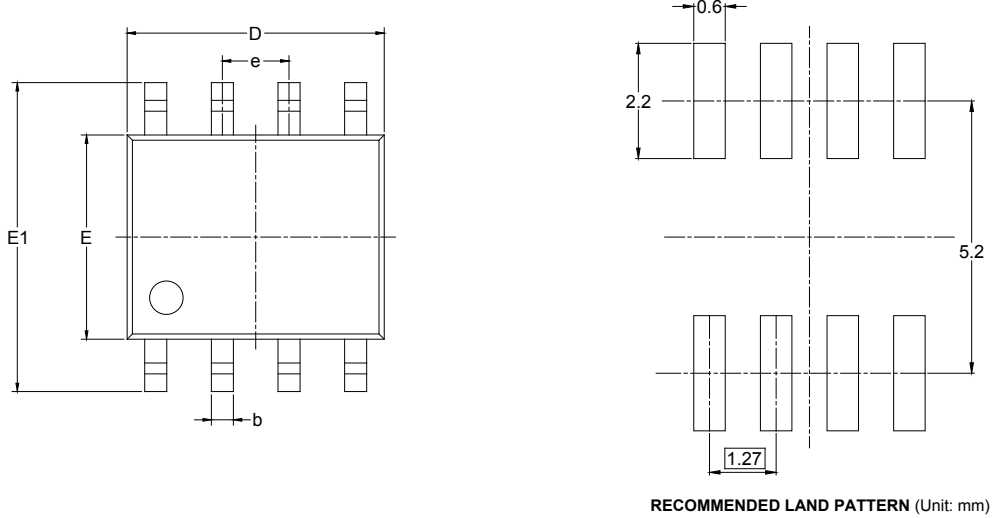

Symbol	Dimensions In Millimeters		Dimensions In Inches	
	MIN	MAX	MIN	MAX
A	1.350	1.750	0.053	0.069
A1	0.100	0.250	0.004	0.010
A2	1.350	1.550	0.053	0.061
b	0.330	0.510	0.013	0.020
c	0.170	0.250	0.006	0.010
D	4.700	5.100	0.185	0.200
E	3.800	4.000	0.150	0.157
E1	5.800	6.200	0.228	0.244
e	1.27 BSC		0.050 BSC	
L	0.400	1.270	0.016	0.050
θ	0°	8°	0°	8°

PACKAGE OUTLINE DIMENSIONS

MSOP-8

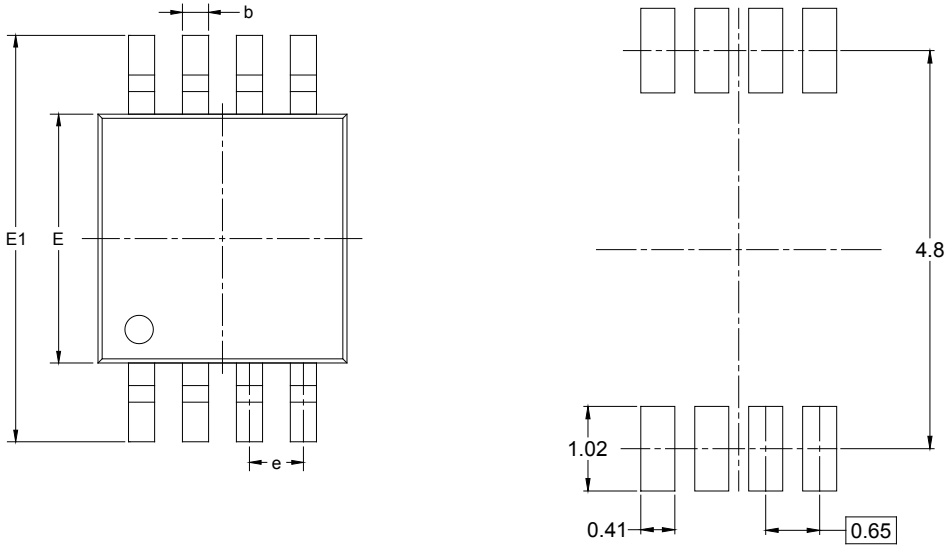

RECOMMENDED LAND PATTERN (Unit: mm)

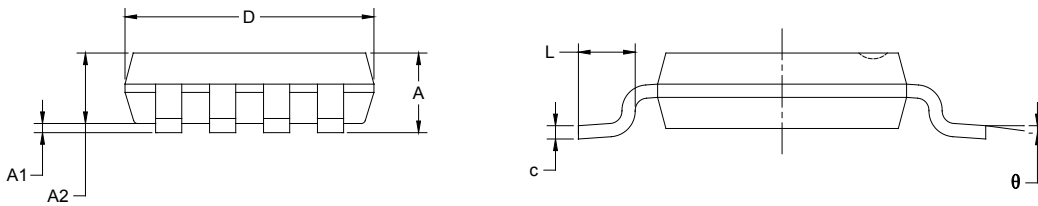

Symbol	Dimensions In Millimeters		Dimensions In Inches	
	MIN	MAX	MIN	MAX
A	0.820	1.100	0.032	0.043
A1	0.020	0.150	0.001	0.006
A2	0.750	0.950	0.030	0.037
b	0.250	0.380	0.010	0.015
c	0.090	0.230	0.004	0.009
D	2.900	3.100	0.114	0.122
E	2.900	3.100	0.114	0.122
E1	4.750	5.050	0.187	0.199
e	0.650 BSC		0.026 BSC	
L	0.400	0.800	0.016	0.031
θ	0°	6°	0°	6°

PACKAGE OUTLINE DIMENSIONS

SOIC-14

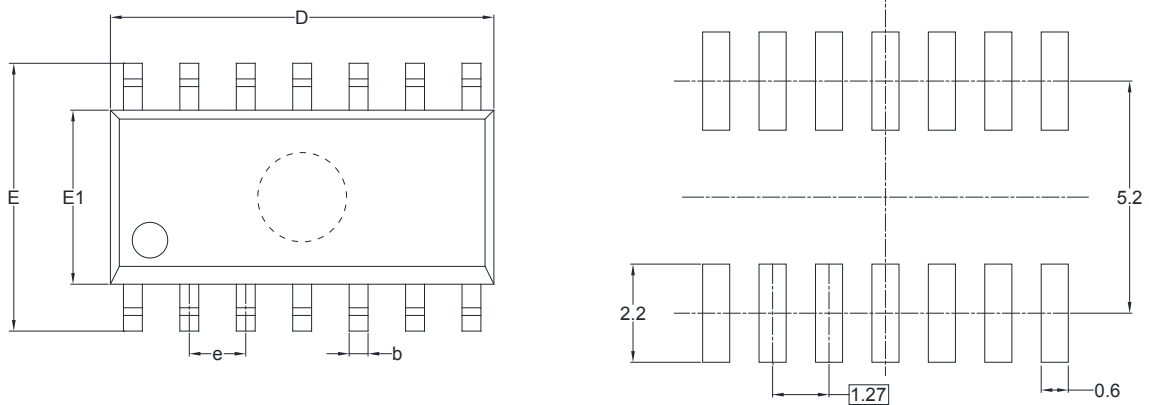

RECOMMENDED LAND PATTERN (Unit: mm)

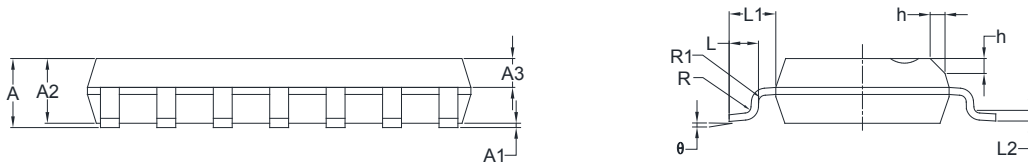

Symbol	Dimensions In Millimeters		Dimensions In Inches	
	MIN	MAX	MIN	MAX
A	1.35	1.75	0.053	0.069
A1	0.10	0.25	0.004	0.010
A2	1.25	1.65	0.049	0.065
A3	0.55	0.75	0.022	0.030
b	0.36	0.49	0.014	0.019
D	8.53	8.73	0.336	0.344
E	5.80	6.20	0.228	0.244
E1	3.80	4.00	0.150	0.157
e	1.27 BSC		0.050 BSC	
L	0.45	0.80	0.018	0.032
L1	1.04 REF		0.040 REF	
L2	0.25 BSC		0.01 BSC	
R	0.07		0.003	
R1	0.07		0.003	
h	0.30	0.50	0.012	0.020
θ	0°	8°	0°	8°

PACKAGE OUTLINE DIMENSIONS

TSSOP-14

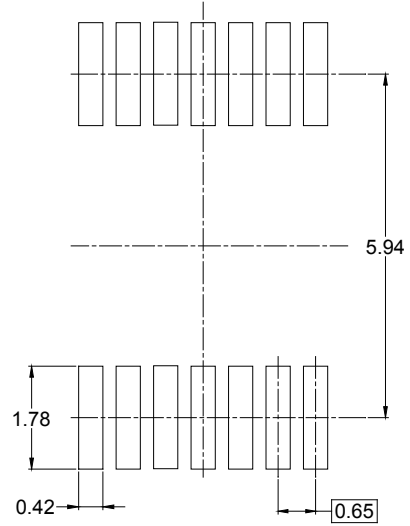
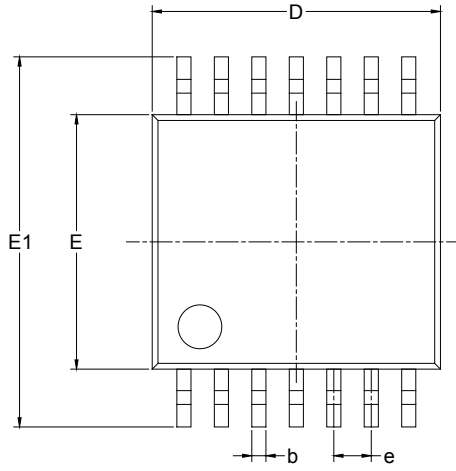

RECOMMENDED LAND PATTERN (Unit: mm)

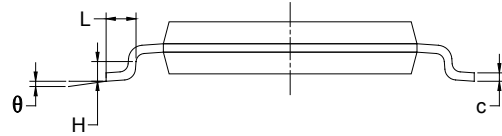
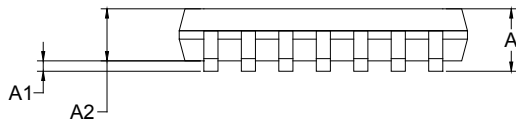

Symbol	Dimensions In Millimeters		Dimensions In Inches	
	MIN	MAX	MIN	MAX
A		1.200		0.047
A1	0.050	0.150	0.002	0.006
A2	0.800	1.050	0.031	0.041
b	0.190	0.300	0.007	0.012
c	0.090	0.200	0.004	0.008
D	4.860	5.100	0.191	0.201
E	4.300	4.500	0.169	0.177
E1	6.250	6.550	0.246	0.258
e	0.650 BSC		0.026 BSC	
L	0.500	0.700	0.02	0.028
H	0.25 TYP		0.01 TYP	
θ	1°	7°	1°	7°

PACKAGE INFORMATION

TAPE AND REEL INFORMATION

REEL DIMENSIONS



TAPE DIMENSIONS



NOTE: The picture is only for reference. Please make the object as the standard.

KEY PARAMETER LIST OF TAPE AND REEL

Package Type	Reel Diameter	Reel Width W1 (mm)	A0 (mm)	B0 (mm)	K0 (mm)	P0 (mm)	P1 (mm)	P2 (mm)	W (mm)	Pin1 Quadrant
SOT-23-5	7"	9.5	3.20	3.20	1.40	4.0	4.0	2.0	8.0	Q3
SOIC-8	13"	12.4	6.40	5.40	2.10	4.0	8.0	2.0	12.0	Q1
MSOP-8	13"	12.4	5.20	3.30	1.50	4.0	8.0	2.0	12.0	Q1
SOIC-14	13"	16.4	6.60	9.30	2.10	4.0	8.0	2.0	16.0	Q1
TSSOP-14	13"	12.4	6.95	5.60	1.20	4.0	8.0	2.0	12.0	Q1

D20001

PACKAGE INFORMATION

CARTON BOX DIMENSIONS



NOTE: The picture is only for reference. Please make the object as the standard.

KEY PARAMETER LIST OF CARTON BOX

Reel Type	Length (mm)	Width (mm)	Height (mm)	Pizza/Carton
7" (Option)	368	227	224	8
7"	442	410	224	18
13"	386	280	370	5

DD0002