

## N-Channel 30-V(D-S) MOSFET

$V_{(BR)DSS}$	$R_{DS(on)MAX}$	$I_D$
30V	0.025Ω@10V	5.8A
	0.035Ω@4.5V	

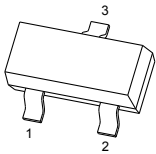
### General FEATURE

- TrenchFET Power MOSFET
- Lead free product is acquired
- Surface mount package

### APPLICATION

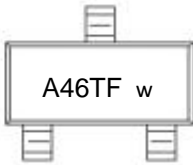
- Load Switch for Portable Devices
- DC/DC Converter

**SOT-23**



1.GATE  
2.SOURCE  
3.DRAIN

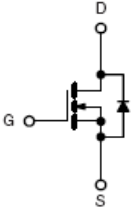
**MARKING**



A46TF w

\*w: week code

**Equivalent Circuit**



### Maximum ratings ( $T_a=25^{\circ}\text{C}$ unless otherwise noted)

Parameter	Symbol	Value	Unit
Drain-Source Voltage	$V_{DS}$	30	V
Gate-Source Voltage	$V_{GS}$	±20	
Continuous Drain Current	$I_D$	5.8	A
Pulsed Drain Current*1	$I_{DM}$	20	
Continuous Source-Drain Diode Current	$I_S$	1.0	
Maximum Power Dissipation	$P_D$	1.4	W
Thermal Resistance from Junction to Ambient( $t \leq 10\text{s}$ )	$R_{\theta JA}$	89	$^{\circ}\text{C/W}$
Junction Temperature	$T_J$	-55 ~+150	$^{\circ}\text{C}$
Storage Temperature	$T_{stg}$	-55 ~+150	

Note :

\*1. Pulse Width  $\leq 300\mu\text{s}$ , Duty cycle  $\leq 2\%$

## MOSFET ELECTRICAL CHARACTERISTICS

T<sub>a</sub> =25 °C unless otherwise specified

Parameter	Symbol	Test Condition	Min	Typ	Max	Units
<b>Static</b>						
Drain-source breakdown voltage	V <sub>(BR)DSS</sub>	V <sub>GS</sub> = 0V, I <sub>D</sub> = 250μA	30	-	-	V
Gate-source threshold voltage	V <sub>GS(th)</sub>	V <sub>DS</sub> =V <sub>GS</sub> , I <sub>D</sub> = 250μA	1.2	1.6	2.4	
Gate-source leakage	I <sub>GSS</sub>	V <sub>DS</sub> =0V, V <sub>GS</sub> =±20V	-	-	±100	nA
Zero gate voltage drain current	I <sub>DSS</sub>	V <sub>DS</sub> =24V, V <sub>GS</sub> =0V	-	-	100	nA
Drain-source on-state resistance <sup>a</sup>	R <sub>DS(on)</sub>	V <sub>GS</sub> =10V, I <sub>D</sub> =5.8A	-	0.023	0.025	Ω
		V <sub>GS</sub> =4.5V, I <sub>D</sub> =5A	-	0.032	0.035	
Forward transconductance <sup>a</sup>	g <sub>fs</sub>	V <sub>DS</sub> =5V, I <sub>D</sub> =5A	-	15	-	S
<b>Dynamic<sup>b</sup></b>						
Input capacitance	C <sub>iss</sub>	V <sub>DS</sub> =15V, V <sub>GS</sub> =0V, f =1MHz	-	255	-	pF
Output capacitance	C <sub>oss</sub>		-	45	-	
Reverse transfer capacitance	C <sub>rss</sub>		-	35	-	
Total gate charge	Q <sub>g</sub>	V <sub>DS</sub> =15V, V <sub>GS</sub> =10V, I <sub>D</sub> =5.0A	-	5.2	-	nC
Gate-source charge	Q <sub>gs</sub>		-	0.85	-	
Gate-drain charge	Q <sub>gd</sub>		-	1.3	-	
Turn-on delay time	t <sub>d(on)</sub>	V <sub>DD</sub> =15V, R <sub>L</sub> =3Ω V <sub>GS</sub> =10V, R <sub>gen</sub> =3Ω	-	4.5	-	ns
Rise time	t <sub>r</sub>		-	2.5	-	
Turn-off delay time	t <sub>d(off)</sub>		-	14.5	-	
Fall time	t <sub>f</sub>		-	3.5	-	
<b>Drain-source body diode characteristics</b>						
Continuous source-drain diode current	I <sub>S</sub>	T <sub>C</sub> =25°C	-	-	2.5	A
Body diode voltage	V <sub>SD</sub>	I <sub>S</sub> =1.0A	-	0.7	1.0	V

### Notes :

a.Pulse Test : Pulse Width < 300μs, Duty Cycle ≤2%.

b.Guaranteed by design, not subject to production testing.

## Typical Electrical and Thermal Characteristics

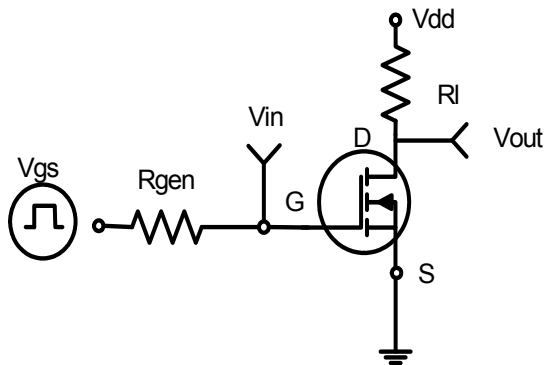


Figure 1: Switching Test Circuit

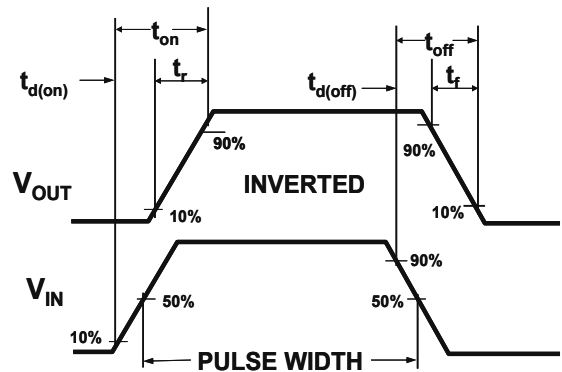


Figure 2: Switching Waveforms

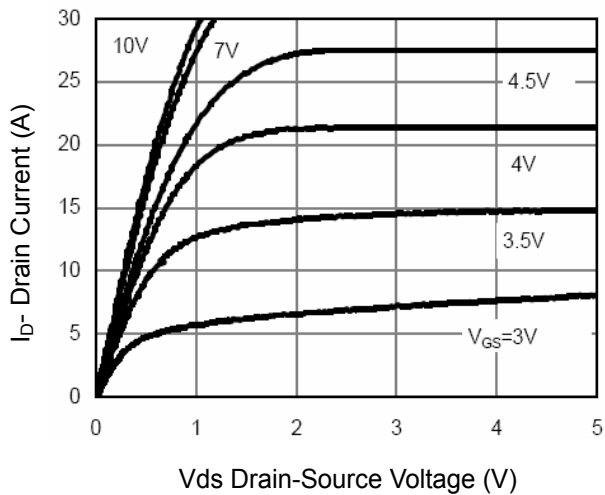


Figure 3 Output Characteristics

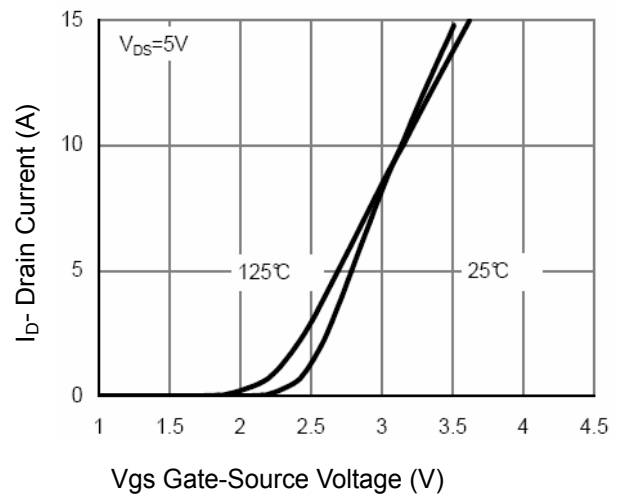


Figure 4 Transfer Characteristics

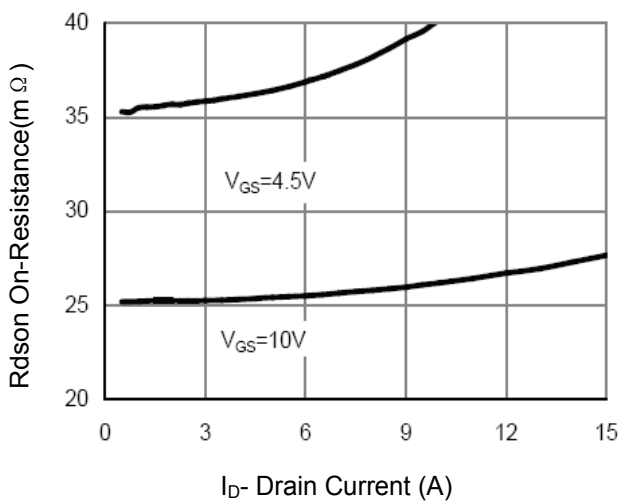


Figure 5 Drain-Source On-Resistance

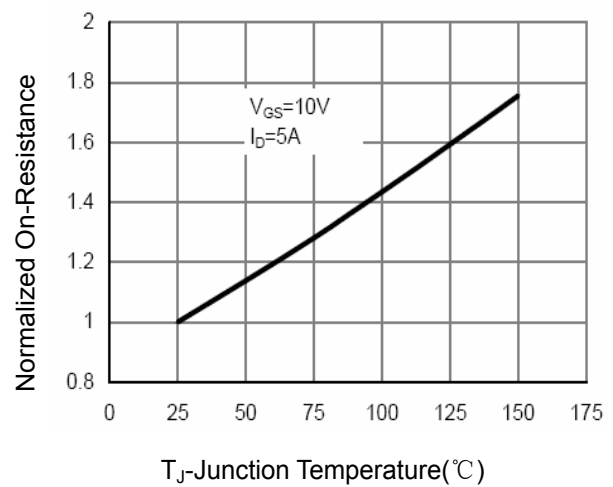
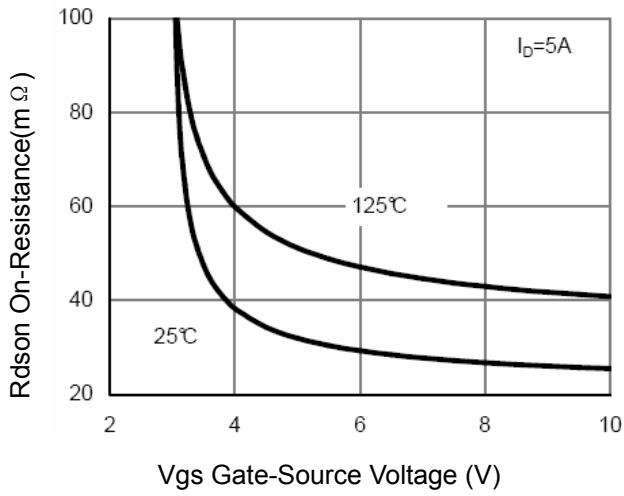
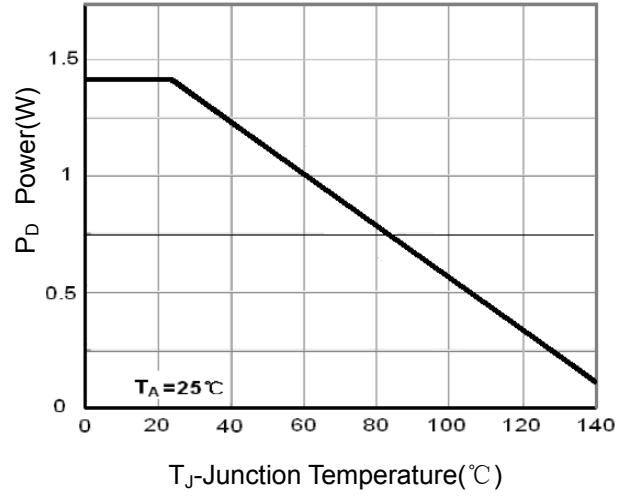


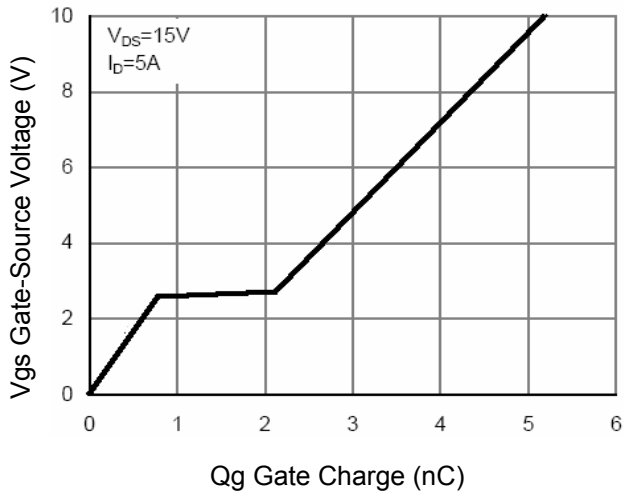
Figure 6 Drain-Source On-Resistance



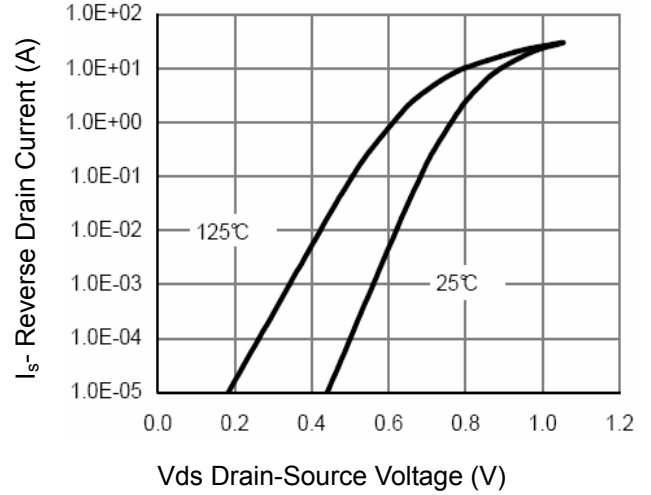
**Figure 7 Rdson vs Vgs**



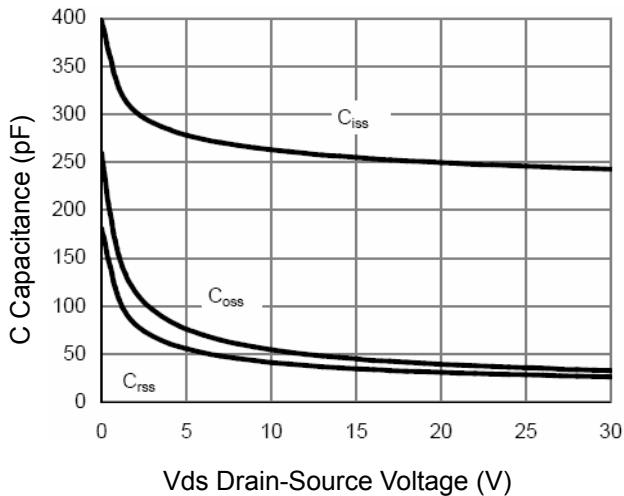
**Figure 8 Power Dissipation**



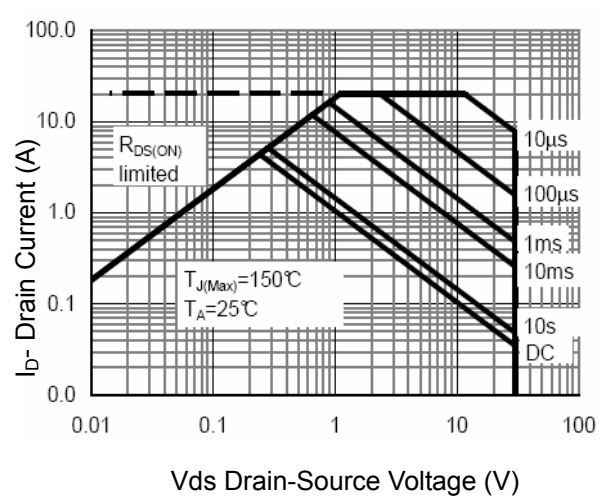
**Figure 9 Gate Charge**



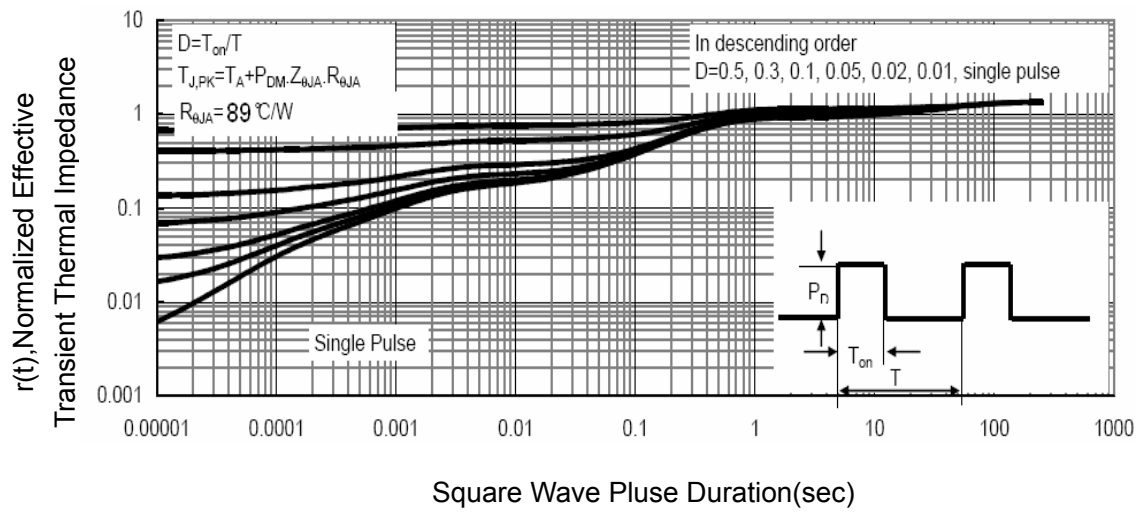
**Figure 10 Source- Drain Diode Forward**



**Figure 11 Capacitance vs Vds**

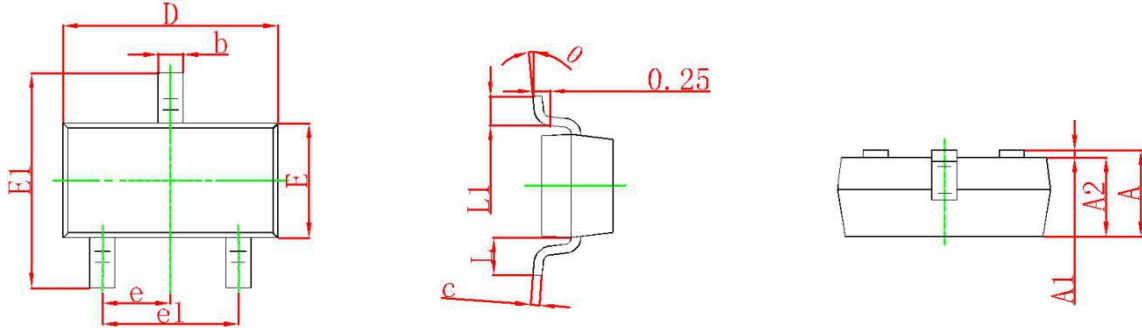


**Figure 12 Safe Operation Area**



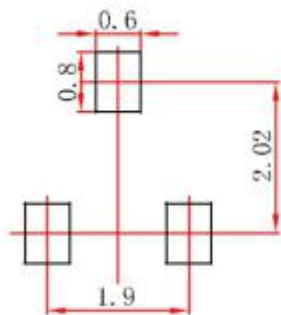
**Figure 13 Normalized Maximum Transient Thermal Impedance**

## SOT-23 Package Outline Dimensions



Symbol	Dimensions In Millimeters		Dimensions In Inches	
	Min	Max	Min	Max
A	0.900	1.150	0.035	0.045
A1	0.000	0.100	0.000	0.004
A2	0.900	1.050	0.035	0.041
b	0.300	0.500	0.012	0.020
c	0.080	0.150	0.003	0.006
D	2.800	3.000	0.110	0.118
E	1.200	1.400	0.047	0.055
E1	2.250	2.550	0.089	0.100
e	0.950 TYP		0.037 TYP	
e1	1.800	2.000	0.071	0.079
L	0.550 REF		0.022 REF	
L1	0.300	0.500	0.012	0.020
θ	0°	8°	0°	8°

## SOT-23 Suggested Pad Layout



- Note:
1. Controlling dimension: in millimeters.
  2. General tolerance:  $\pm 0.05\text{mm}$ .
  3. The pad layout is for reference purposes only.