

DIN 43589-1

Euro Battery Connector / Euro-Batteriestecker
Connectors for Industrial Vehicles / Stecker Für Industriefahrzeuge

- 80 Amps - 160 Amps - 320 Amps • Meets or Exceeds EN1175-1 • RoHS Compliant
- Acid & Impact Resistant • Industrial Applications
- 80 A - 160 A - 320 A • Erfüllt oder übertrifft EN1175-1 • RoHS-konform
- Säure-und schlagfest • Industrieanwendungen



APP
Anderson Power Products®

An **IDEAL** Company

Euro Battery Connector

The Anderson™ family of Euro Battery Connectors (EBC) are expertly designed for ease of use and incorporate an innovative contact carrier to simplify assembly. The EBC connectors include the industry standard 80, 160, and 320 sizes, all in accordance with DIN 43589-1. Design and materials offer performance that meets or exceeds all the requirements of EN1175-1. All Materials chosen are RoHS compliant and selected to ensure years of reliability in adverse industrial environments. These attributes make the EBC DIN connectors the ideal choice for a wide range of industrial applications in Material Handling, Battery Charging, Utility Vehicles, Motive Power, and Sweepers/ Scrubbers amongst many others.



Key Attributes

Safety Agency Approvals - UL, CSA, and EN1175-1:1998 (Abr. EN1175-1)



Meets DIN 43589-1- Offers interface compatibility for housings, contacts and air tubes.

Voltage Keying - EBC connectors offer keys for Dry-Cell, Wet-Cell, and Universal applications coded for 24/36/48/72/80 and 96 volts DC applications.

Sturdy Advanced Polymer Housings - Provide superior resistance to impact, acid and temperature extremes.

Silver Plated Copper Contacts - Provide excellent conductivity and superior mating cycle performance.

©2019 Anderson Power Products, Inc. All rights reserved. APP®, Anderson Power Products®, SB®, SBE®, SBX®, SBS® and the APP Logo are registered trademarks of Anderson Power Products, Inc. Anderson™ is a trademark of Anderson Power Products, Inc.

Anderson will use reasonable efforts to include accurate and up-to-date content in the catalog. All product information contained in the catalog including ordering information, illustrations, specifications, and dimensions, are believed to be reliable as of the date of publishing, but is subject to change without notice. Anderson makes no warranty or representation as to its accuracy. Content in the catalog may contain technical inaccuracies, typographical errors and may be changed or updated without notice. Anderson may also make improvements and/or changes to the products and/or to the programs described in the content at any time without notice. Current sales drawings and specifications are available upon request.

Neither Anderson nor any party involved in creating, producing, or delivering this catalog shall be liable for any direct, incidental, consequential, indirect, or punitive damages arising out of your use of this catalog or any errors or omissions in its content.

Specifications

Electrical

Current Ratings (Amperes)

Wire Size:	EBC 80			EBC 160			EBC 320		
	EN1175*	CSA**	UL***	EN1175*	CSA**	UL***	EN1175*	CSA**	UL***
10 mm ²	95	70	90	N/A	N/A	N/A	N/A	N/A	N/A
16 mm ²	125	90	120	115	90	120	N/A	N/A	N/A
25 mm ²	145	110	140	160	120	160	N/A	N/A	N/A
35 mm ²	165	120	160	185	140	180	N/A	N/A	N/A
50 mm ²	N/A	N/A	N/A	225	160	220	225	165	220
75 mm ²	N/A	N/A	N/A	N/A	N/A	N/A	260	200	260
95 mm ²	N/A	N/A	N/A	N/A	N/A	N/A	350	260	340

* EN1175:1998 allows for maximum temperature rise = 65°C (above 20±5°C ambient)

** CSA allows for maximum temperature rise = 30°C

*** UL allows for total temperature (based on min. 25°C ambient) = 75°C

Voltage Ratings

	EBC 80			EBC 160			EBC 320		
	EN1175	CSA	UL	EN1175	CSA	UL	EN1175	CSA	UL
AC / DC	150V	600V	600V	150V	600V	600V	150V	600V	600V
DWV (AC)	2000	2200		2000	2200		2000	2200	

Wire Range

	EBC 80		EBC 160		EBC 320	
	mm ²	AWG	mm ²	AWG	mm ²	AWG
Power - Min.	10	#8	16	#6	50	1/0
Power - Max.	35	#2	50	1/0	95	3/0
Upper Aux. - Min.	1.5	#18	4	#12	4	#12
Upper Aux. - Max.	2.5	#14	4	#12	4	#12
Lower Pilot Aux. - Min.	1.5	#18	6	#10	6	#10
Lower Pilot Aux. - Max.	2.5	#14	6	#10	6	#10

Average Initial Contact Resistance Across Mated Connector- micro-ohms

	EBC 80	EBC 160	EBC 320
Avg. Contact Resistance - Power	176	95	77
Avg. Contact Resistance - Aux.	1100	920	1000

Operating Temperature (all Series): -25 to 75°C

Mechanical

Life Cycle - Per EN1175-1

	EBC 80	EBC 160	EBC 320
No Load	>5000	>5000	>5000
Under Load (Hot Plug at 96V)	5 at 200A	5 at 400A	5 at 800A

Misc. Data

	EBC 80	EBC 160	EBC 320
Avg. Mating Force N (lb)	68 (15.3)	170 (38.2)	71 (16.0)
Contact Retention N (lb)	134(30) min	445(100) min	445(100) min
Degree of Protection	IP23	IP23	IP23
Acid Resistance (1.40g/cm ³ at 20°C)	16 hours	16 hours	16 hours
Air Tube Max Pressure Bar (PSI)	0.8 (11.6)	0.8 (11.6)	0.8 (11.6)

Materials

	EBC 80 - EBC 160 - EBC 320
Housings	PBT/PC Blend
Contacts	Copper Alloy
Contact Plating - Power (min.)	Silver Plating - 6 microns
Contact Plating - Auxiliary (min.)	Silver Plating - 6 microns
Hardware	Steel, Zn Chromate

Temperature Charts

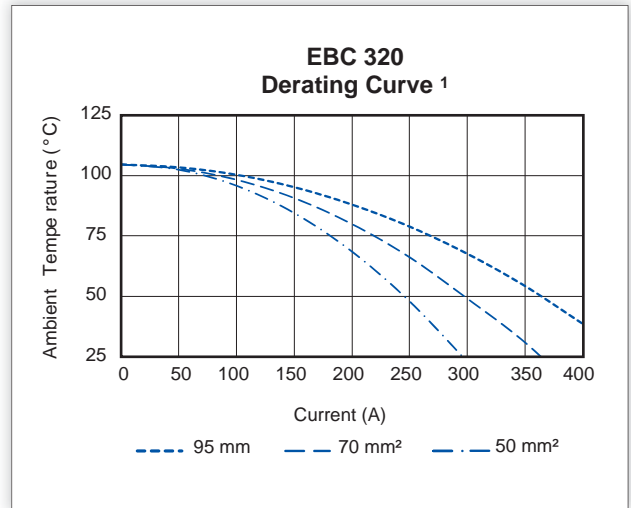
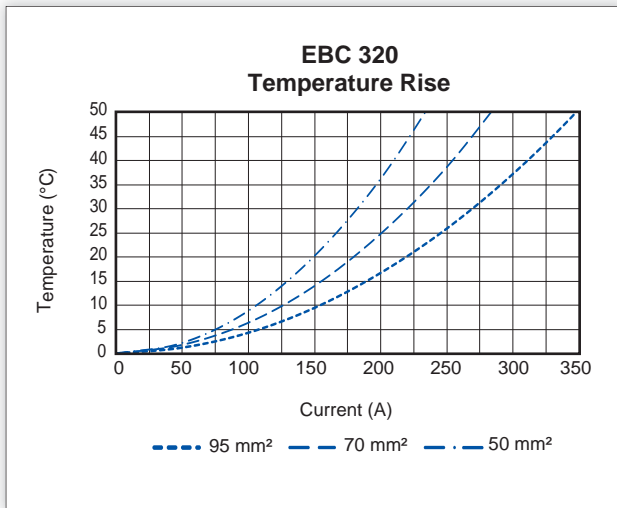
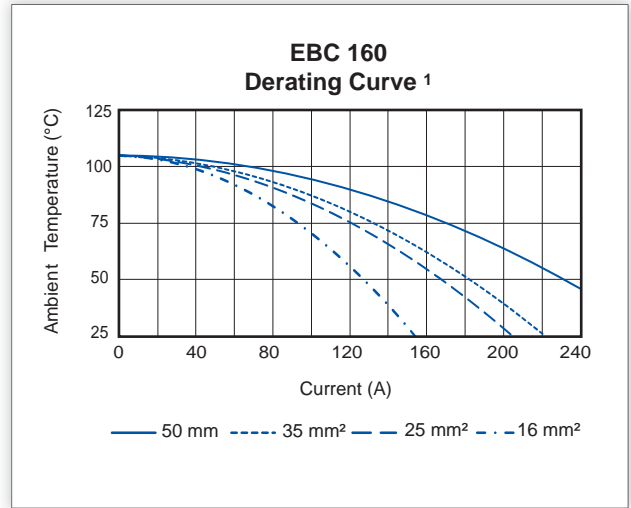
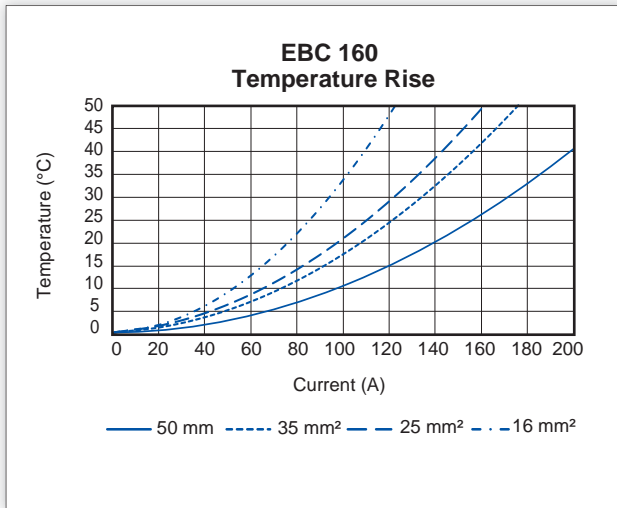
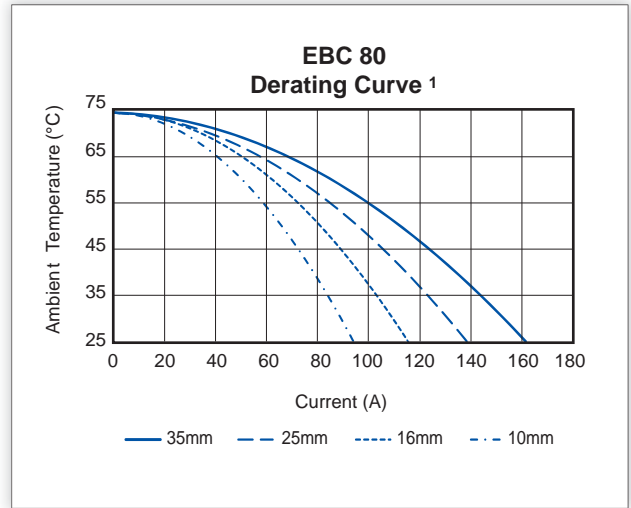
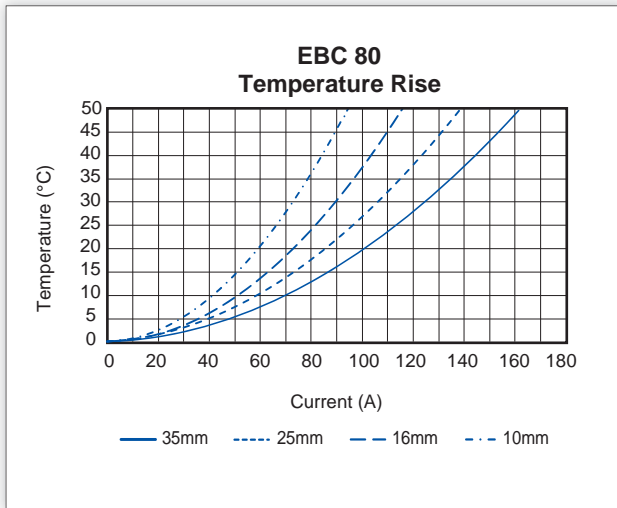

¹ 0.8 Derating per IEC 60512-3

NOTE 1: Temperature ratings based on power contacts energized only.

NOTE 2: Temperature rise charts are based on a 25°C ambient temperature.

Ordering Information

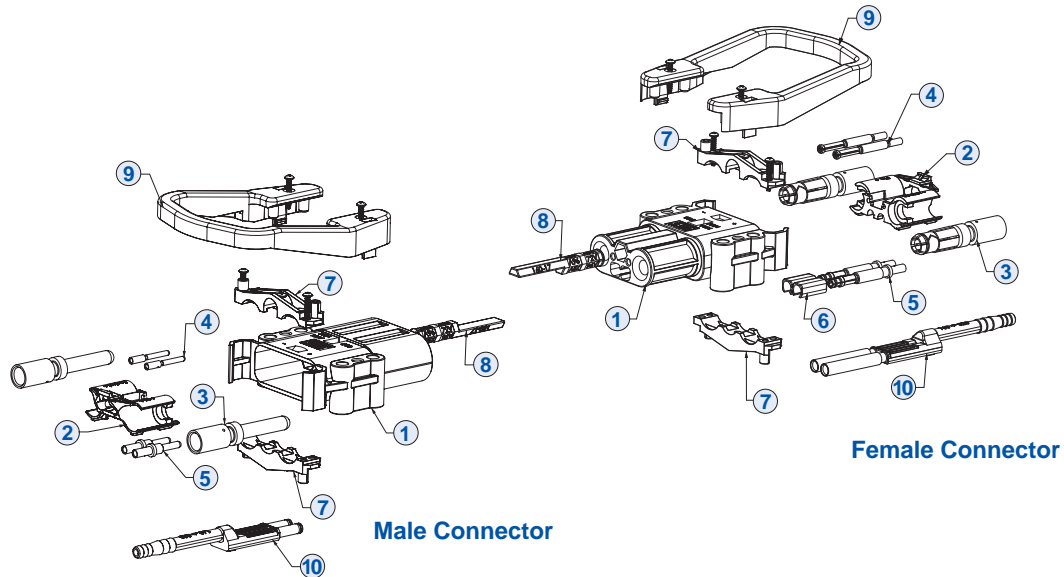

Components							
Item Number	Description - mm (AWG)	EBC 80		EBC 160		EBC 320	
		Male	Female	Male	Female	Male	Female
3	Power Contacts						
	Power Contact 10 mm ² (8 AWG)	80-1010	80-1110	N/A	N/A	N/A	N/A
	Power Contact 16 mm ² (6 AWG)	80-1016	80-1116	160-1016	160-1116	N/A	N/A
	Power Contact 25 mm ² (4 AWG)	80-1025	80-1125	160-1025	160-1125	N/A	N/A
	Power Contact 35 mm ² (2 AWG)	80-1035	80-1135	160-1035	160-1135	N/A	N/A
	Power Contact 50 mm ² (1 AWG to 1/0)	N/A	N/A	160-1050	160-1150	320-1050	320-1150
	Power Contact 70 mm ² (2/0 to 3/0)	N/A	N/A	N/A	N/A	320-1070	320-1170
	Power Contact 95 mm ² (3/0 to 4/0)	N/A	N/A	N/A	N/A	320-1095	320-1195
4	Upper Auxiliary Contact	E80-32	E80-33	E160-32	E160-33	E320-34	E320-35
5	* Lower Pilot Auxiliary Contact	E80-30	E80-31	160-12	160-13	160-12	160-13
8	Voltage Coding Pins						
	Grey Coding Pin - wet (160 and 320 use same Coding Pins)	80-9	80-9	160-9	160-9	160-9	160-9
	Green Coding Pin - dry (160 and 320 use same Coding Pins)	80-17	80-17	160-17	160-17	160-17	160-17
	** Yellow Coding Pin - univ (160 and 320 use same Coding Pins)	80-19	Not Used	160-19	Not Used	160-19	Not Used
9	*** Handle - High Profile w/screws	N/A	N/A	E320-89	E320-89	E320-89	E320-89
	*** Handle - Low Profile w/screws	E80-89	E80-89	E160-89	E160-89	E160-89	E160-89
	Handle Red - Low profile w/screws	80-8-R	80-8-R	N/A	N/A	N/A	N/A
10	* Air Tube	E80-20	E80-21	E160-20	E160-21	E320-20	E320-21
1	Housing Only	EP80-1	EP80-2	EP160-1	EP160-2	EP320-1	EP320-2
2	Contact Holder	80-5B	80-5B	EP160-5	EP160-5	EP320-5	EP320-5
6	Supplemental Lower Pilot Aux Holder	Not Used	Not Used	Not Used	EP320-38	Not Used	EP320-38
7	Cable Clamps with Screws	EP80-67	EP80-67	EP160-67	EP160-67	EP320-67	EP320-67
1+2+7+ 8	Male Housing with Contact Holder and Cable Clamp with Screws (Gray Key) - Individual Pack	E80400-0009		E16400-0009		E32400-0009	
1+2+6+7+8	Female Housing with Contact Holder, **** Lower Pilot aux Holder, Cable Clamps with Screws - (Gray Key) - Individual Pack		E80500-0009		E16500-0009		E32500-0009
1+2+7+ 8	Male Housing with Contact Holder and Cable Clamp with Screws (Green Key) - Individual Pack	E80400-0209		E16400-0209		E32400-0209	
1+2+6+7+8	Female Housing with Contact Holder, **** Lower Pilot aux Holder, Cable Clamps with Screws - (Green Key) - Individual Pack		E80500-0209		E16500-0209		E32500-0209
1+2+7+ 8	Male Housing with Contact Holder and Cable Clamp with Screws (Yellow Key) - Individual Pack	E80400-0309		E16403-0309		E32400-0309	

* Lower pilot auxiliary contacts use the same housing location as air tubes so they can not be used together

** Universal yellow coding key is only used on male connectors

*** EBC 160 and EBC 320 handles work with both the EBC 160 and EBC 320 series connectors

**** No lower pilot auxiliary holder required on EBC 80 size connectors

Part Number Configurator

EBC 80 Connector Part Number Selection

Series	Gender	Main Contact	Handle	Coding Key	Auxiliary Contacts & Air Tubes	Packing	
E80	4 or 5	25	- 1	0	2	9	
4	Male					9 Individual	
5	Female					8 Bulk	
00	None - Order Separately					0 None	
10	10 mm ² (#8 AWG)					1 (2) Lower Pilot Auxiliary Contacts	
16	16 mm ² (#6 AWG)					2 (2) Upper Auxiliary Contacts	
25	25 mm ² (#4 AWG)					4 (2) Lower Pilot Auxiliary Contacts & (2) Upper Auxiliary Contacts	
35	35 mm ² (#2 AWG)					5 Air Tube	
0	No		0	Grey, Wet Cell	6 Air Tube & (2) Upper Auxiliary Contacts		
1	Black		2	Green, Dry Cell			
2	Red		3	Yellow, Universal (use with male housing only)			



EBC 160 Connector Part Number Selection

Series	Gender	Main Contact	Handle	Coding Key	Auxiliary Contacts & Air Tubes	Packing	
E16	4 or 5	25	- 1	0	2	9	
4	Male					9 Individual	
5	Female					8 Bulk	
00	None - Order Separately					0 None	
16	16 mm ² (#6 AWG)					1 (2) Lower Pilot Auxiliary Contacts	
25	25 mm ² (#4 AWG)					2 (2) Upper Auxiliary Contacts	
35	35 mm ² (#2 AWG)					4 (2) Lower Pilot Auxiliary Contacts & (2) Upper Auxiliary Contacts	
50	50 mm ² (1/0 AWG to #1 AWG)					5 Air Tube	
0	No		0	Grey, Wet Cell	6 Air Tube & (2) Upper Auxiliary Contacts		
1	Black		2	Green, Dry Cell			
			3	Yellow, Universal (use with male housing only)			



EBC 320 Connector Part Number Selection

Series	Gender	Main Contact	Handle	Coding Key	Auxiliary Contacts & Air Tubes	Packing	
E32	4 or 5	50	- 1	0	2	9	
4	Male					9 Individual	
5	Female					8 Bulk	
00	None - Order Separately					0 None	
50	50 mm ² (1/0 AWG to #1 AWG)					1 (2) Lower Pilot Auxiliary Contacts	
70	70 mm ² (2/0 AWG to 3/0 AWG)					2 (2) Upper Auxiliary Contacts	
95	95 mm ² (3/0 AWG to 4/0 AWG)					4 (2) Lower Pilot Auxiliary Contacts & (2) Upper Auxiliary Contacts	
0	No				5 Air Tube		
1	Black		0	Grey, Wet Cell	6 Air Tube & (2) Upper Auxiliary Contacts		
			2	Green, Dry Cell			
			3	Yellow, Universal (use with male housing only)			



Packaging:

Individual (Kits) - all components for a complete connector are packaged together in individual bags within one box

Bulk (Kits) - all components required are packaged separately by part number selected in one bag/box

Handles:

EBC 80 comes with the low profile T handle • EBC 160 come with the low profile handle • EBC 320 come with the high profile handle.

Drawings



Housing Dimensions							
		EBC 80		EBC 160		EBC 320	
		mm	in	mm	in	mm	in
Male Housings	A	68.0	2.68	83.5	3.29	89.5	3.52
	B	74.4	2.93	103.8	4.09	123.5	4.86
	C	26.1	1.03	33.4	1.31	40.8	1.61
Female Housings	A	68.0	2.68	83.5	3.29	89.5	3.52
	B	73.8	2.91	104.0	4.09	117.0	4.61
	C	26.1	1.03	32.6	1.28	37.6	1.48

Male Front View

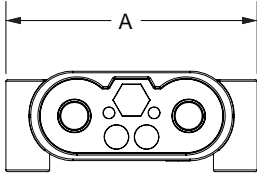

Male Top View

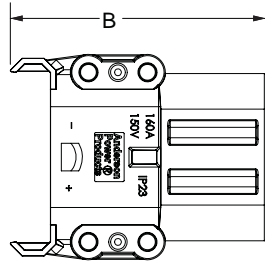

Male Side View

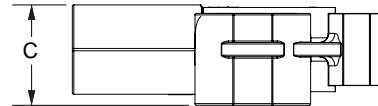

Female Front View

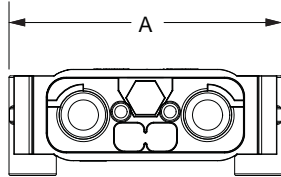

Female Top View

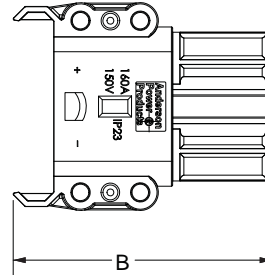

Female Side View

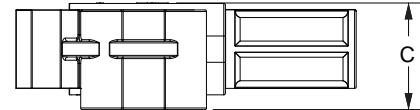

Dimensions of Housings With Handles

		EBC 80	
		mm	in
Male Housings	D	68.0	2.68
	E	41.2	1.62
	F	110.6	4.35
Female Housings	D	70.0	2.76
	E	41.2	1.62
	F	110.6	4.35

EBC 80 Male Housing with Handle

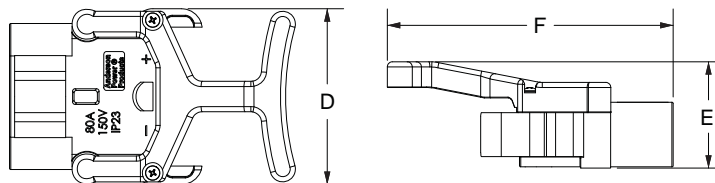

EBC 80 Female Housing with Handle

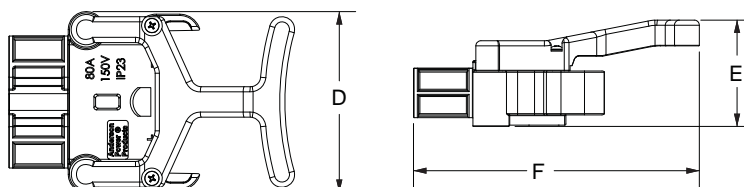

EBC 160 Handles											
		Low Profile		High Profile				Low Profile		High Profile	
		mm	in	mm	in			mm	in	mm	in
Male Housings	D	101	4.0	106	4.2	Female Housings	D	101	4.0	106	4.2
	E	46	1.8	64	2.5		E	46	1.8	64	2.5
	F	168	6.6	167	6.6		F	173	6.8	172	6.8

**Male Housing
Low Profile Handle**

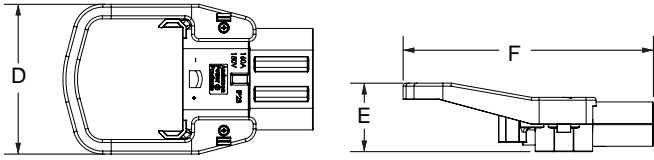

**Male Housing
High Profile Handle**

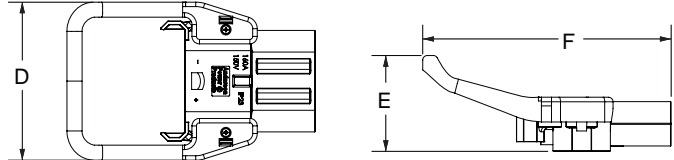

**Female Housing
Low Profile Handle**

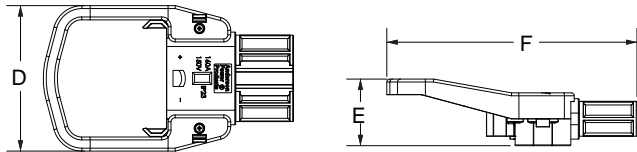

**Female Housing
High Profile Handle**

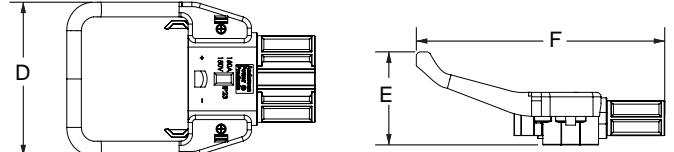

EBC 320 Handles											
		Low Profile		High Profile				Low Profile		High Profile	
		mm	in	mm	in			mm	in	mm	in
Male Housings	D	101	4.0	106	4.2	Female Housings	D	101	4.0	106	4.2
	E	54	2.1	72	2.8		E	53	2.1	71	2.8
	F	175	6.9	174	6.9		F	71	2.8	173	6.8

**Male Housing
Low Profile Handle**

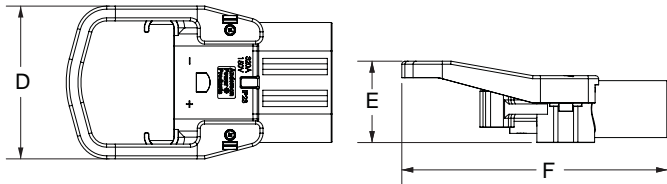

**Male Housing
High Profile Handle**

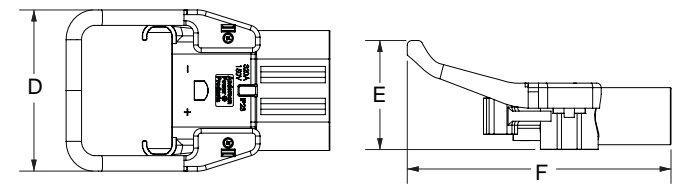

**Female Housing
Low Profile Handle**

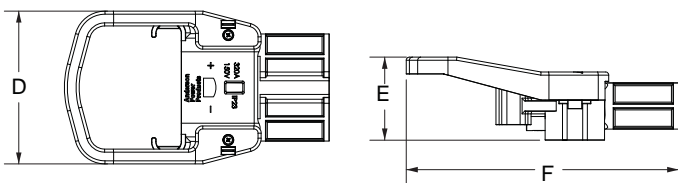

**Female Housing
High Profile Handle**

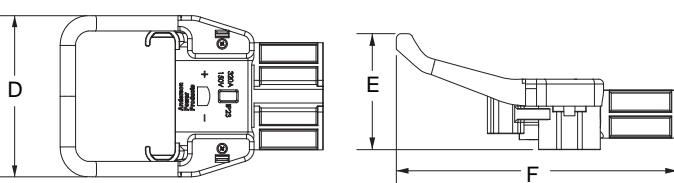

Latch Plate 160 & 320
P/N: A320-LP

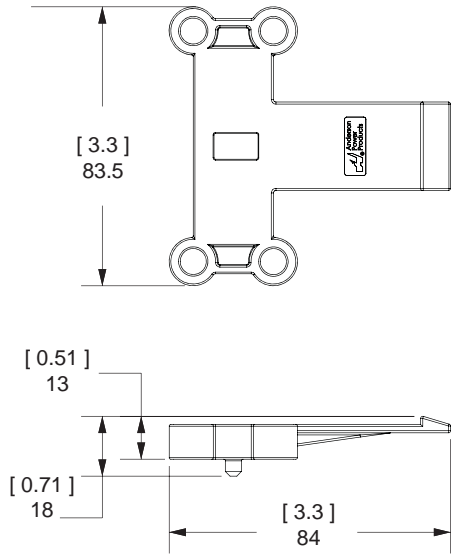

Latch Plate on
EBC 160 & 320 Male Housing

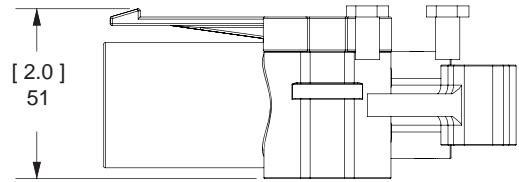

Handle & Lever Assembly
on EBC 160 & 320 Female Housing:
P/N: A320HL

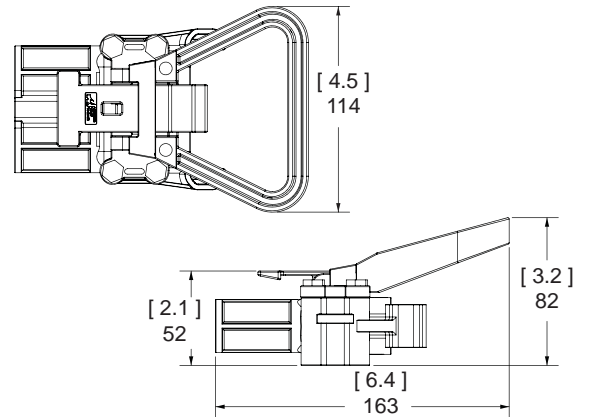

Manual Release for EBC 160 & 320
P/N: 994G4

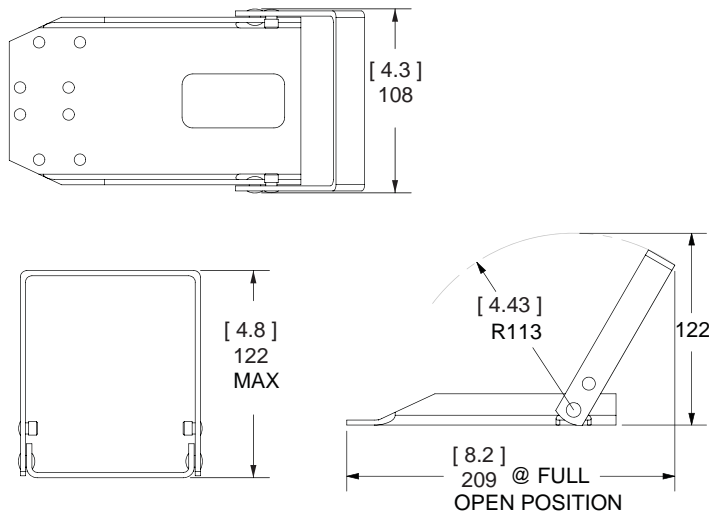

Battery Bracket - P/N: 993G4

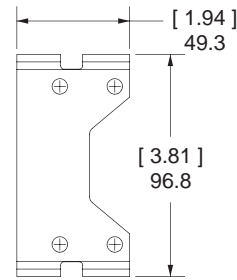

Manual Release with Connectors

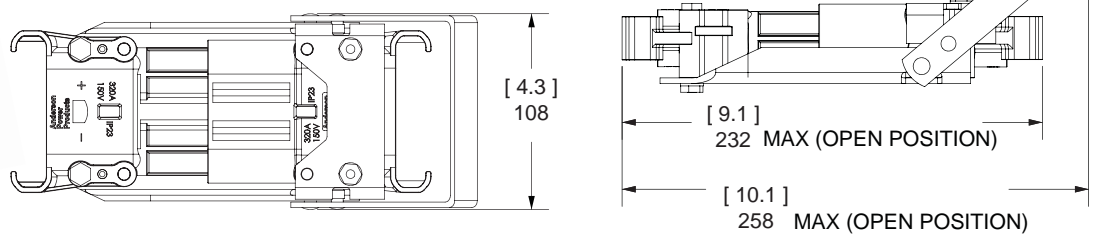

Contacts						
Series	Wire Size		OD		ID	
	Metric	AWG	mm	in	mm	in
EBC 80	10 mm ²	#6 to 8	6.0	0.24	4.5	0.18
EBC 80 / 160	16 mm ²	#4 to 6	8.4	0.33	6.0	0.24
	25 mm ²	#2 to 4	11.0	0.43	8.0	0.31
	35 mm ²	#1 to 2	12.5	0.49	9.0	0.35
EBC 160 / 320	50 mm ²	#1 to 1/0	14.5	0.57	11.0	0.43
EBC 320	70 mm ²	2/0 to 3/0	17.0	0.67	13.0	0.51
	95 mm ²	3/0 to 4/0	19.8	0.78	15.0	0.59



Male Power Contact

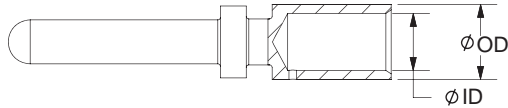

Female Power Contact

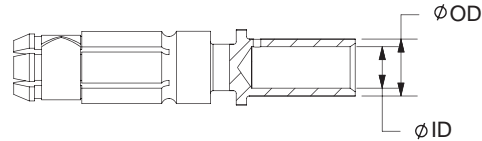

Upper Auxiliaries						Lower Pilot Auxiliaries						
Series	Wire Size		OD		ID		Wire Size	AWG	OD		ID	
	mm ²	AWG	mm	in	mm	in			mm ²	AWG	mm	in
EBC 80	2.5	#14 to #18	3.9	0.15	2.2	0.09	2.5	#14-18	3.9	0.15	2.2	0.09
EBC 160 / 320	4	#12	4.1	0.16	2.9	0.11	6.0	#10	5.0	0.20	3.9	0.15

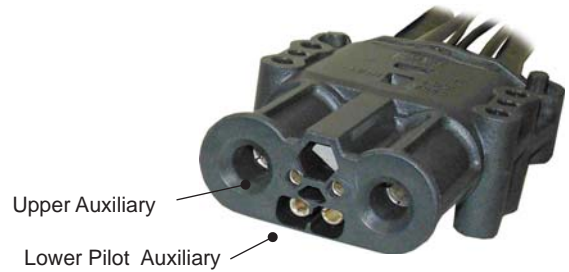

Upper Auxiliary Pin

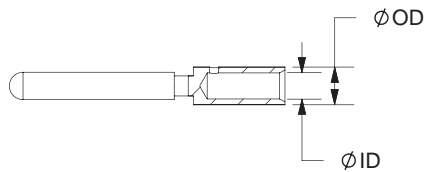

Upper Auxiliary Socket

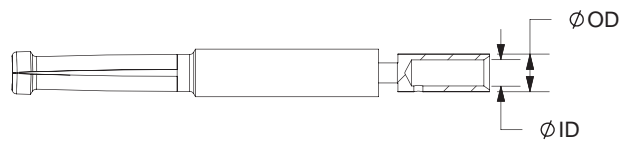

Lower Pilot Auxiliary Pin

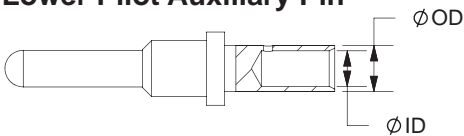

Lower Pilot Auxiliary Socket



Female Twin Air Tube							Male Twin Air Tube					
Series	G		H		J		G		H		J	
	mm	in	mm	in	mm	in	mm	in	mm	in	mm	in
EBC 80	102	4.0	15.8	0.62	13.0	0.51	87	3.4	15.8	0.62	13.0	0.51
EBC 160 / 320	154	6.1	17.8	0.70	13.9	0.55	125	4.9	17.8	0.70	14.0	0.55

Female Air Tube

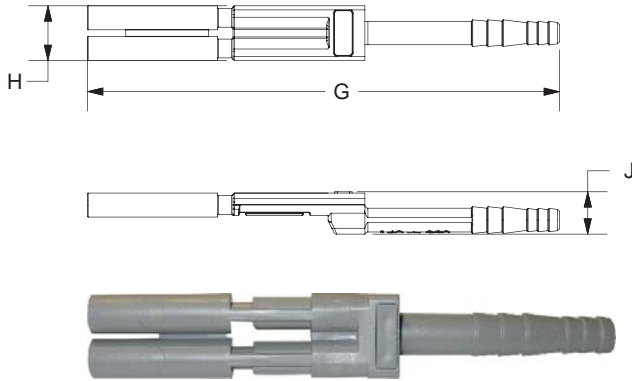

Male Air Tube

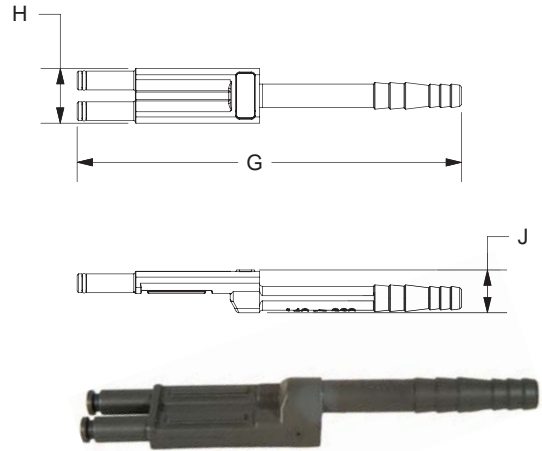

Wet / Dry Voltage Key					Universal Voltage Key			
Series	K		L		K		L	
	mm	in	mm	in	mm	in	mm	in
EBC 80	8.0	0.31	45	1.77	8.0	0.31	46	1.8
EBC 160 / 320	9.3	0.37	69	2.72	11.8	0.46	69	2.7

Wet / Dry Voltage Key - Grey or Green

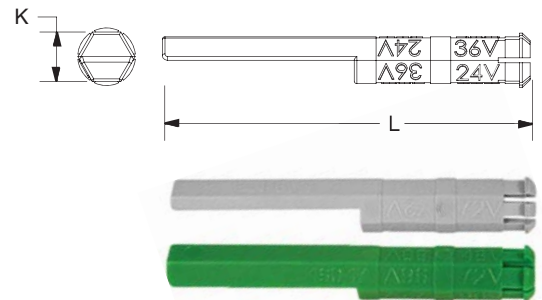

Keying Plug	Identification	Assembled In
	Used for Wet Cell Battery /Charger - Color Grey	Battery Receptacle and Charging Plug
	Used for Dry Cell Battery/Charger - Color Green	Battery Receptacle and Charging Plug
	Used for Vehicle only - Yellow (Universal)	Vehicle Plug only - used when vehicle may use wet or dry cell batteries.

Universal Voltage Key - Yellow

(use with male housing only)

Universal (Yellow) voltage keys are to be used exclusively at the vehicle side to permit both the use of wet-cell and dry-cell batteries.

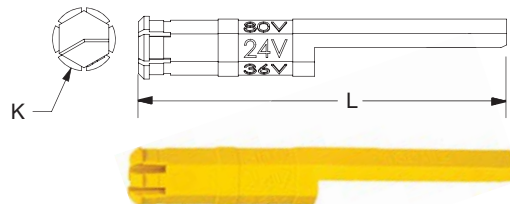

Tooling Information

EBC 80A, 160A, & 320A (DIN) Pneumatic Tooling

Wire Size		Part Numbers		Loose Piece Contact Crimp Tools								
mm ²	AWG	Power Contact	Pneumatic Bench Tool	+	Die	+	Locator (Single Crimp)					
10 mm ²	#8 to #6	80-1010	TBD		TBD		TBD					
		80-1110										
16 mm ²	#6 to #4	80-1016										
		80-1116										
25 mm ²	#4 to #2	80-1025										
		80-1125										
35 mm ²	#2 to #1	80-1035										
		80-1135										
mm ²	AWG	Power Contact						Pneumatic Bench Tool	+	Die	+	Locator (Double Crimp)
16 mm ²	#6 to #4	160-1016						1387G2		1303G14		1304G21 Socket 1304G20 Pin
		160-1116										
25 mm ²	#4 to #2	160-1025										
		160-1125										
35 mm ²	#2 to #1	160-1035										
		160-1135										
50 mm ²	#1 to 1/0	160-1050										
		160-1150										
50 mm ²	#1 to 1/0	320-1050	1387G2		1303G8		1304G29 Pin					
		320-1150										
70 mm ²	2/0 AWG 3/0 AWG	320-1070										
		320-1170										
95 mm ²	3/0 AWG 4/0 AWG	320-1095										
		320-1195										
Pilot/Auxiliary Contacts												
ALL		All Crimp Pins All Crimp Sockets			SOLDER ONLY							



1387G1 & 1387G2



1370G1 & 1387G3

EBC 80A, 160A, & 320A (DIN) Hydraulic Tooling

Wire Size		Part Numbers		Loose Piece Contact Crimp Tools							
mm ²	AWG	Power Contact	Hydraulic Hand Tool	+	Die	OR	Hydraulic Hand Tool				
10 mm ²	#8 to #6	80-1010	1387G3 OR 1370G1		1322G16		N/A				
		80-1110									
16 mm ²	#6 to #4	80-1016									
		80-1116									
25 mm ²	#4 to #2	80-1025									
		80-1125									
35 mm ²	#2 to #1	80-1035			N/A			N/A	N/A	N/A	
		80-1135									
16 mm ²	#6 to #4	160-1016			1387G3 OR 1370G1				1322G9		1368 Series
		160-1116									
25 mm ²	#4 to #2	160-1025									
		160-1125									
35 mm ²	#2 to #1	160-1035									
		160-1135									
50 mm ²	#1 to 1/0	160-1050									
		160-1150									
50 mm ²	#1 to 1/0	320-1050	1387G3 OR 1370G1			1322G4			1368 Series		
		320-1150									
70 mm ²	2/0 AWG 3/0 AWG	320-1070									
		320-1170									
95 mm ²	3/0 AWG 4/0 AWG	320-1095									
		320-1195									
Pilot/Auxiliary Contacts											
ALL		Pins Sockets			SOLDER ONLY						



1368



1368-NL



1368-B

* Use 1322G3 with K stranded wire only.

Euro-Batteriestecker

Die Euro-Batteriestecker (Euro Battery Connectors, EBC) der Anderson™-Familie wurden fachkundig mit dem Ziel der einfachen Bedienbarkeit konzipiert und weisen einen innovativen Kontaktträger auf, der die Montage vereinfacht. Die EBC-Stecker liegen in den industriellen Standardgrößen 80, 160 und 320 vor, die alle der Norm DIN 43589-1 entsprechen. Design und Materialien bieten Leistungsmerkmale, die alle Anforderungen der Norm EN1175-1 erfüllen oder übertreffen. Alle ausgewählten Materialien sind RoHS-konform und wurden so ausgewählt, dass jahrelange Zuverlässigkeit in schwierigen Industrieumgebungen gewährleistet wird. Dank dieser Attribute sind die EBC-DIN-Stecker die richtige Wahl für eine breite Palette an industriellen Einsatzmöglichkeiten bei Materialhandhabung, Batterieaufladung, Nutzfahrzeugen, Antriebstechnik, Kehrmaschinen und vielen weiteren Anwendungen.



Hauptmerkmale

Sicherheitszertifizierungen – UL, CSA und EN1175-1:1998 (Abr. EN1175-1)

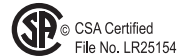

Erfüllt DIN 43589-1 – Bietet Schnittstellenkompatibilität für die Gehäuse, die Kontakte und die Luftadapter.

Spannungscodierstifte – EBC-Stecker bieten Codierstifte für Trockenzellen-, Nasszellen und universelle Anwendungen, die für DC-Anwendungen mit 24/36/48/72/80 und 96 Volt codiert sind.

Stabile, moderne Polymer-Gehäuse – Bieten überragenden Widerstand bei Schlag-, Säure- und Temperaturbelastungen.

Versilberte Kupferkontakte – Bieten hervorragende Leitfähigkeit und überragende Steckzyklen.

© 2019 Anderson Power Products, Inc. Alle Rechte vorbehalten. APP®, Anderson Power Products®, SB®, SBE®, SBX®, SBS® und das APP-Logo sind registrierte Warenzeichen von Anderson Power Products, Inc. Anderson™ ist ein Warenzeichen von Anderson Power Products, Inc.

Anderson wird angemessene Anstrengungen unternehmen, um genaue und aktuelle Inhalte in den Katalog aufzunehmen. Alle im Katalog enthaltenen Produktinformationen einschließlich der Bestellinformationen, Abbildungen, Spezifikationen und Abmessungen gelten zum Zeitpunkt der Veröffentlichung als zuverlässig, können sich jedoch ohne vorherige Ankündigung ändern. Anderson übernimmt keine Garantie oder Gewährleistung für die Richtigkeit. Der Inhalt des Katalogs kann technische Ungenauigkeiten und typografische Fehler enthalten und kann ohne vorherige Ankündigung geändert oder aktualisiert werden. Anderson kann außerdem jederzeit und ohne vorherige Ankündigung Verbesserungen und / oder Änderungen an den in den Inhalten beschriebenen Produkten und / oder Programmen vornehmen. Aktuelle Zeichnungen/Datenblätter und Spezifikationen sind auf Anfrage erhältlich.

Weder Anderson noch eine Partei, die an der Erstellung, Produktion oder Lieferung dieses Katalogs beteiligt ist, haften für direkte, zufällige, indirekte oder strafbare Folgen Schäden, die durch die Verwendung dieses Katalogs oder durch Fehler oder Auslassungen in seinem Inhalt entstehen.

Spezifikationen

Elektrische Werte

Stromstärke (Ampere)

Kabelquerschnitt:	EBC 80			EBC 160			EBC 320		
	EN1175*	CSA**	UL***	EN1175*	CSA**	UL***	EN1175*	CSA**	UL***
10 mm ²	95	70	90	N/V	N/V	N/V	N/V	N/V	N/V
16 mm ²	125	90	120	115	90	120	N/V	N/V	N/V
25 mm ²	145	110	140	160	120	160	N/V	N/V	N/V
35 mm ²	165	120	160	185	140	180	N/V	N/V	N/V
50 mm ²	N/V	N/V	N/V	225	160	220	225	165	220
75 mm ²	N/V	N/V	N/V	N/V	N/V	N/V	260	200	260
95 mm ²	N/V	N/V	N/V	N/V	N/V	N/V	350	260	340

* EN1175:1998 erlaubt einen maximalen Temperaturanstieg von 65 °C (über 20±5 °C der Umgebungstemperatur)

** CSA erlaubt einen maximalen Temperaturanstieg von 30 °C

*** UL erlaubt eine Temperatur insgesamt (basierend auf min. 25 °C Umgebungstemperatur) von 75 °C

Betriebsspannung

	EBC 80			EBC 160			EBC 320		
	EN1175	CSA	UL	EN1175	CSA	UL	EN1175	CSA	UL
AC/DC	150 V	600 V	600 V	150 V	600 V	600 V	150 V	600 V	600 V
DWV (AC)	2000	2200	2200	2200	2200	2000	2200	2200	2200

Kabelbereich

	EBC 80		EBC 160		EBC 320	
	mm ²	AWG	mm ²	AWG	mm ²	AWG
Strom – Min.	10	Nr. 8	16	Nr. 6	50	1/0
Strom – Max.	35	Nr. 2	50	1/0	95	3/0
Oberer Hilfs. – Min.	1,5	Nr. 18	4	Nr. 12	4	Nr. 12
Oberer Hilfs. – Max.	2,5	Nr. 14	4	Nr. 12	4	Nr. 12
Unterer Führungs-/Hilfs. – Min.	1,5	Nr. 18	6	Nr. 10	6	Nr. 10
Unterer Führungs-/Hilfs. – Max.	2,5	Nr. 14	6	Nr. 10	6	Nr. 10

Durchschnittlicher Anfangskontaktwiderstand in zusammengefügem Steckeranschluss – Mikrohm

	EBC 80	EBC 160	EBC 320
Durchschn. Kontaktwiderstand – Strom	176	95	77
Durchschn. Kontaktwiderstand – Hilfs.	1100	920	1000

Betriebstemperatur (alle Serien): -25 bis 75 °C

Mechanische Werte

Lebenszyklus - Für EN1175-1

	EBC 80	EBC 160	EBC 320
Keine Belastung	> 5000	> 5000	> 5000
Unter Belastung (Hot-Plugging bei 96 V)	5 bei 200 A	5 bei 400 A	5 bei 800 A

Versch. Daten

	EBC 80	EBC 160	EBC 320
Durchschn. Steckkraft N (lb)	68 (15,3)	170 (38,2)	71 (16,0)
Kontakthaltung N (lb)	134 (30) min	445 (100) min	445 (100) min
Schutzgrad	IP23	IP23	IP23
Säurewiderstand (1,40 g/cm ³ bei 20 °C)	16 Stunden	16 Stunden	16 Stunden
Max. Druckbelastung in Bar (PSI) Luftadapter	0,8 (11,6)	0,8 (11,6)	0,8 (11,6)

Materialien

	EBC 80 - EBC 160 - EBC 320
Gehäuse	PBT/PC-Blend
Kontakte	Kupferlegierung
Kontaktbeschichtung – Strom (min.)	Versilbert – 6 Micron
Kontaktbeschichtung – Hilfs. (min.)	Versilbert – 6 Micron
Hardware	Stahl, Zinkchromat

Temperaturtabellen

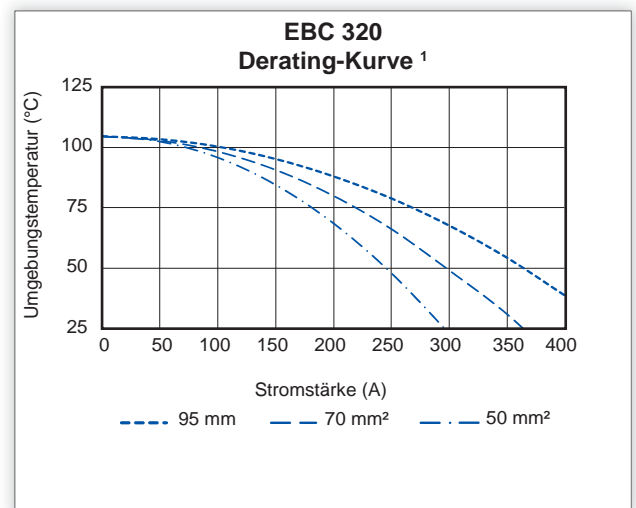
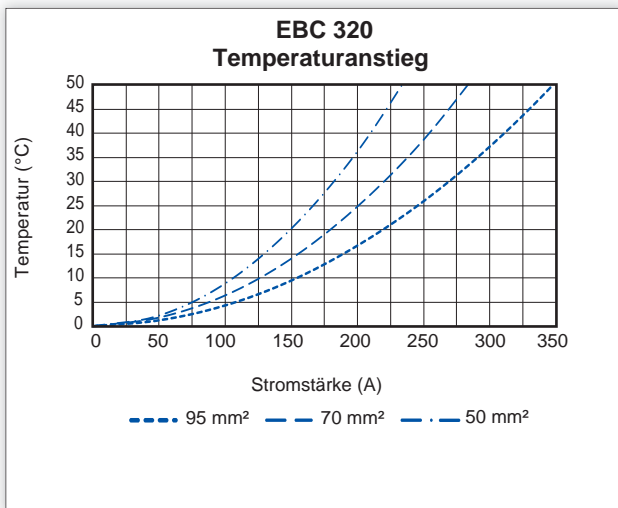
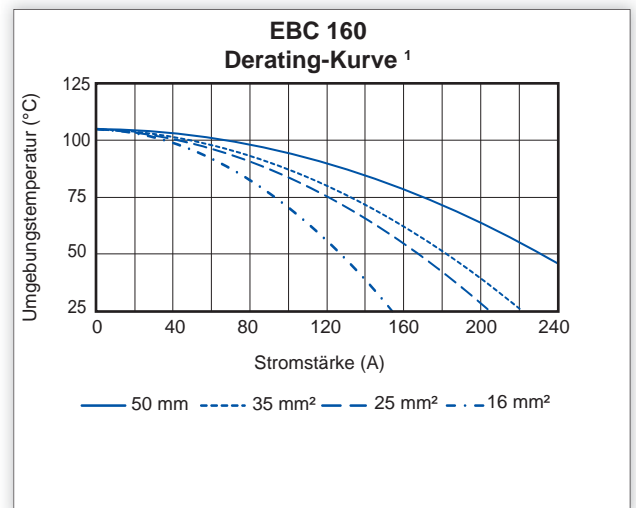
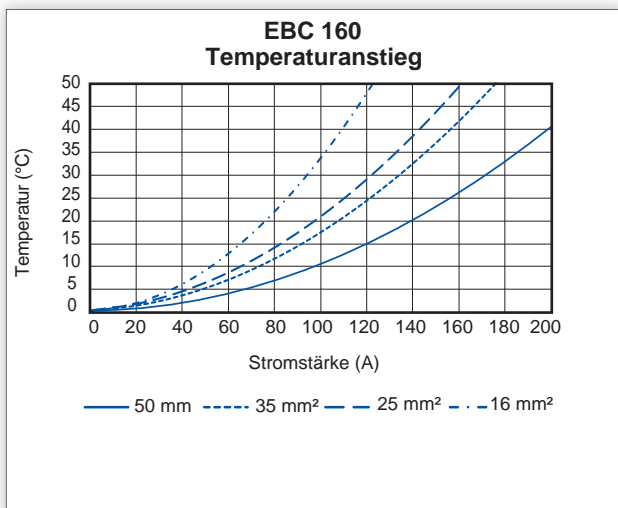
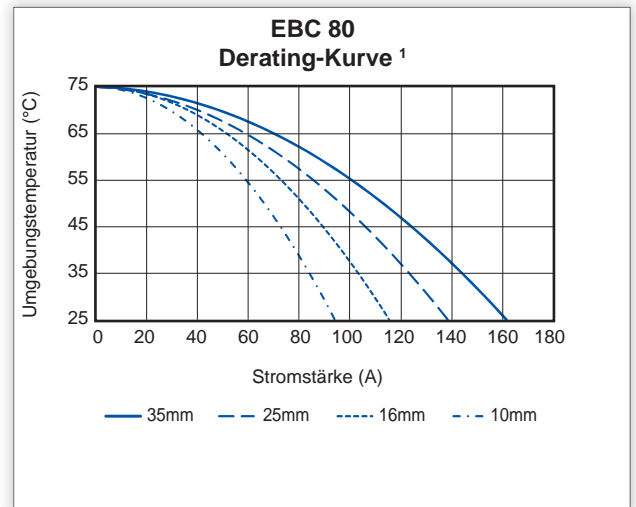
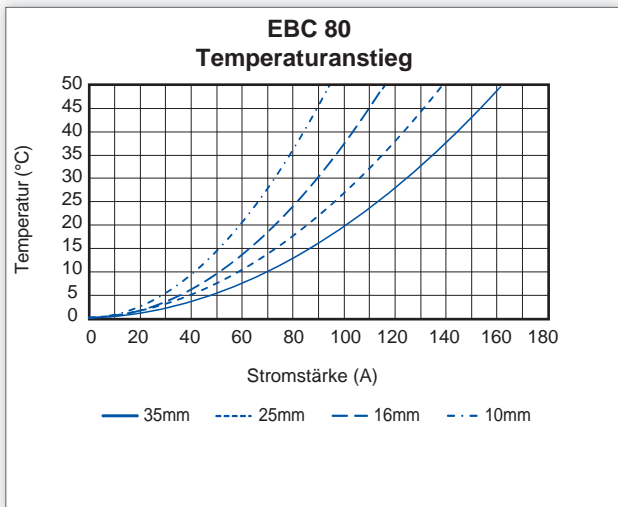

¹ 0,8 Derating pro IEC 60512-3

HINWEIS 1: Temperaturwerte basieren nur auf Kontakten mit eingeschalteter Spannungsversorgung.

HINWEIS 2: Temperaturanstiegsdiagramme basieren auf einer Umgebungstemperatur von 25 ° C.

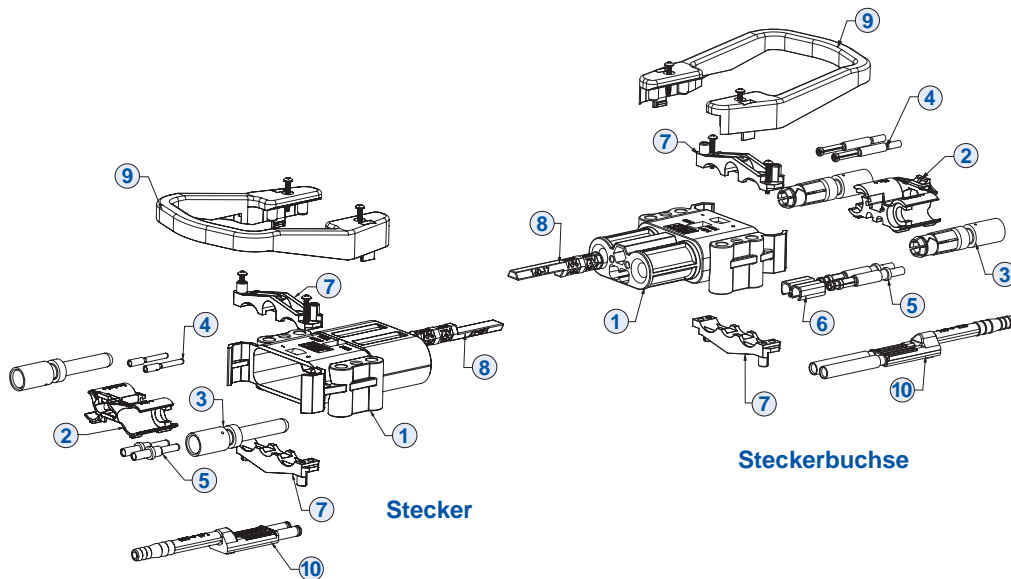

Komponenten

Teilenummer	Beschreibung - mm (AWG)	EBC 80		EBC 160		EBC 320	
		Stecker	Buchse	Stecker	Buchse	Stecker	Buchse
3	Stromkontakte						
	Stromkontakt 10 mm ² (8 AWG)	80-1010	80-1110	N/V	N/V	N/V	N/V
	Stromkontakt 16 mm ² (6 AWG)	80-1016	80-1116	160-1016	160-1116	N/V	N/V
	Stromkontakt 25 mm ² (4 AWG)	80-1025	80-1125	160-1025	160-1125	N/V	N/V
	Stromkontakt 35 mm ² (2 AWG)	80-1035	80-1135	160-1035	160-1135	N/V	N/V
	Stromkontakt 50 mm ² (1 AWG bis 1/0)	N/V	N/V	160-1050	160-1150	320-1050	320-1150
	Stromkontakt 70 mm ² (2/0 bis 3/0)	N/V	N/V	N/V	N/V	320-1070	320-1170
	Stromkontakt 95 mm ² (3/0 bis 4/0)	N/V	N/V	N/V	N/V	320-1095	320-1195
4	Oberer Hilfskontakt	E80-32	E80-33	E160-32	E160-33	E320-34	E320-35
5	* Unterer Führungs-/Hilfskontakt	E80-30	E80-31	160-12	160-13	160-12	160-13
8	Spannungscodierstifte						
	Grauer Codierstift – Nasszelle (160 und 320 verwenden dieselben Codierstifte)	80-9	80-9	160-9	160-9	160-9	160-9
	Grüner Codierstift – Trockenzelle (160 und 320 verwenden dieselben Codierstifte)	80-17	80-17	160-17	160-17	160-17	160-17
	** Gelber Codierstift (160 und 320 verwenden dieselben Codierstifte)	80-19	Nicht verwendet	160-19	Nicht verwendet	160-19	Nicht verwendet
9	*** Griff – hohes Profil m/Schrauben	N/V	N/V	E320-89	E320-89	E320-89	E320-89
	*** Griff – flaches Profil m/Schrauben	E80-89	E80-89	E160-89	E160-89	E160-89	E160-89
	Roter Griff – flaches Profil m/Schrauben	80-8-R	80-8-R	N/V	N/V	N/V	N/V
10	* Luftadapter	E80-20	E80-21	E160-20	E160-21	E320-20	E320-21
1	Nur Gehäuse	EP80-1	EP80-2	EP160-1	EP160-2	EP320-1	EP320-2
2	Kontakthalter	80-5B	80-5B	EP160-5	EP160-5	EP320-5	EP320-5
6	Zusätzlicher unterer Führungs-/Hilfshalter	Nicht verwendet	Nicht verwendet	Nicht verwendet	EP320-38	Nicht verwendet	EP320-38
7	Kabelklemmen mit Schrauben	EP80-67	EP80-67	EP160-67	EP160-67	EP320-67	EP320-67
1+2+7+ 8	Steckergehäuse mit Kontakthalter und Kabelklemme mit Schrauben (grauer Codierstift) – Einzelpackung	E80400-0009		E16400-0009		E32400-0009	
1+2+6+7+8	Buchsengehäuse mit Kontakthalter, **** unterer Führungs-/Hilfshalter, Kabelklemmen mit Schrauben – (grauer Codierstift) – Einzelpackung	E80500-0009		E16500-0009		E32500-0009	
1+2+7+ 8	Steckergehäuse mit Kontakthalter und Kabelklemme mit Schrauben (grüner Codierstift) – Einzelpackung	E80400-0209		E16400-0209		E32400-0209	
1+2+6+7+8	Buchsengehäuse mit Kontakthalter, **** unterer Führungs-/Hilfshalter, Kabelklemmen mit Schrauben – (grüner Codierstift) – Einzelpackung	E80500-0209		E16500-0209		E32500-0209	
1+2+7+ 8	Steckergehäuse mit Kontakthalter und Kabelklemme mit Schrauben (gelber Codierstift) – Einzelpackung	E80400-0309		E16403-0309		E32400-0309	

* Untere Führungs-/Hilfskontakte verwenden dieselbe Gehäuseposition wie Luftadapter. Daher können sie nicht zusammen verwendet werden.

** Der universelle gelbe Codierstift wird nur bei Steckeranschlüssen verwendet.

*** EBC 160- und EBC 320-Griffe können mit den Anschlüssen der EBC 160- und EBC 320-Serie verwendet werden.

**** Für Anschlüsse der Größe EBC 80 sind keine Führungs-/Hilfshalter erforderlich

Konfiguration für Teilenummern

Auswahl der Teilenummer für EBC 80-Stecker

Serie	Geschlecht	Hauptkontakt	Griff	Codierstift	Hilfskontakte & Luftadapter		Verpackung
E80	4 oder 5	25	-	1	0	2	9
4	Stecker						9 Einzelpackung
5	Buchse						8 Großverpackung
00	Keine – Separat bestellen					0	Keine
10	10 mm ² (Nr. 8 AWG)					1	(2) Untere Führungs-/Hilfskontakte
16	16 mm ² (Nr. 6 AWG)					2	(2) Obere Hilfskontakte
25	25 mm ² (Nr. 4 AWG)					4	(2) Untere Führungs-/Hilfskontakte & (2) Obere Hilfskontakte
35	35 mm ² (Nr. 2 AWG)						
0	Nein				0	0	Grau, Nasszelle
1	Schwarz				2	0	Grün, Trockenzelle
2	Rot				3	0	Gelb, universell (Verwendung nur mit Steckergehäuse)



Auswahl der Teilenummer für EBC 160-Stecker

Serie	Geschlecht	Hauptkontakt	Griff	Codierstift	Hilfskontakte & Luftadapter		Verpackung
E16	4 oder 5	25	-	1	0	2	9
4	Stecker						9 Einzelpackung
5	Buchse						8 Großverpackung
00	Keine – Separat bestellen					0	Keine
16	16 mm ² (Nr. 6 AWG)					1	(2) Untere Führungs-/Hilfskontakte
25	25 mm ² (Nr. 4 AWG)					2	(2) Obere Hilfskontakte
35	35 mm ² (Nr. 2 AWG)					4	(2) Untere Führungs-/Hilfskontakte & (2) Obere Hilfskontakte
50	50 mm ² (Nr. 1/0 AWG bis #1 AWG)						
0	Nein				0	0	Grau, Nasszelle
1	Schwarz				2	0	Grün, Trockenzelle
					3	0	Gelb, universell (Verwendung nur mit Steckergehäuse)



Auswahl der Teilenummer für EBC 320-Stecker

Serie	Geschlecht	Hauptkontakt	Griff	Codierstift	Hilfskontakte & Luftadapter		Verpackung
E32	4 oder 5	50	-	1	0	2	9
4	Stecker						9 Einzelpackung
5	Buchse						8 Großverpackung
00	Keine – Separat bestellen					0	Keine
50	50 mm ² (Nr. 1/0 AWG bis #1 AWG)					1	(2) Untere Führungs-/Hilfskontakte
70	70 mm ² (Nr. 2/0 AWG bis 3/0 AWG)					2	(2) Obere Hilfskontakte
95	95 mm ² (Nr. 3/0 AWG bis 4/0 AWG)					4	(2) Untere Führungs-/Hilfskontakte & (2) Obere Hilfskontakte
0	Nein					5	Luftadapter
1	Schwarz				0	0	Grau, Nasszelle
					2	0	Grün, Trockenzelle
					3	0	Gelb, universell (Verwendung nur mit Steckergehäuse)



Verpackung:

Einzelpackung (Kits) – alle Komponenten für einen vollständigen Anschluss werden zusammen in Einzelpackungen in einer Schachtel verpackt.
 Großverpackung (Kits) – alle erforderlichen Komponenten werden nach Teilenummer getrennt in einer Schachtel/Kiste verpackt.

Griffe:

EBC 80 wird mit dem flachen T-Griff geliefert • EBC 160 wird mit dem flachen Griff geliefert • EBC 320 wird mit dem hohen Griff geliefert.



Gehäuseabmessungen

		EBC 80		EBC 160		EBC 320	
		mm	Zoll	mm	Zoll	mm	Zoll
Stecker-gehäuse	A	68,0	2,68	83,5	3,29	89,5	3,52
	B	74,4	2,93	103,8	4,09	123,5	4,86
	C	26,1	1,03	33,4	1,31	40,8	1,61
Buchsen-gehäuse	A	68,0	2,68	83,5	3,29	89,5	3,52
	B	73,8	2,91	104,0	4,09	117,0	4,61
	C	26,1	1,03	32,6	1,28	37,6	1,48

Stecker-Vorderansicht

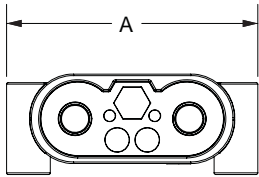

Stecker-Aufsicht

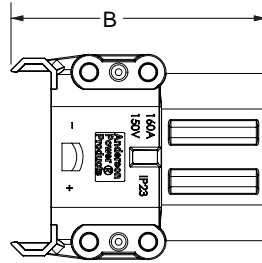

Stecker-Seitenansicht

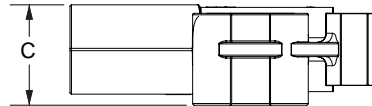

Gehäuse-Vorderansicht

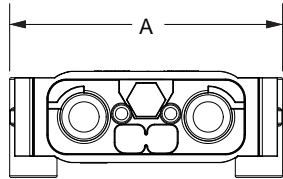

Gehäuse-Aufsicht

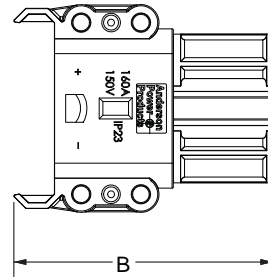

Gehäuse-Seitenansicht

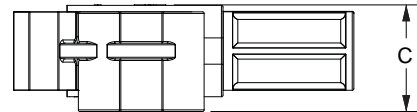

Abmessungen der Gehäuse mit Griffen

		EBC 80	
		mm	Zoll
Stecker-gehäuse	D	68,0	2,68
	E	41,2	1,62
	F	110,6	4,35
Buchsen-gehäuse	D	70,0	2,76
	E	41,2	1,62
	F	110,6	4,35

EBC 80 Steckergehäuse mit Griff

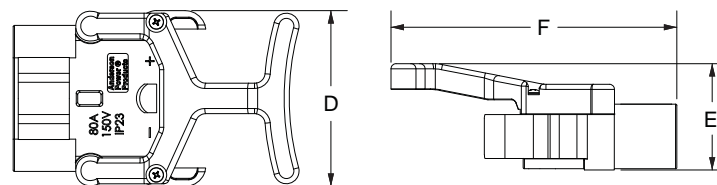

EBC 80 Buchsengehäuse mit Griff

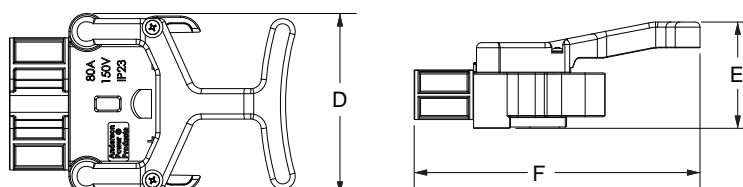

EBC 160-Griffe

		Flaches Profil		Hohes Profil				Flaches Profil		Hohes Profil	
		mm	Zoll	mm	Zoll			mm	Zoll	mm	Zoll
Steckergehäuse	D	101	4,0	106	4,2	Buchsengehäuse	D	101	4,0	106	4,2
	E	46	1,8	64	2,5		E	46	1,8	64	2,5
	F	168	6,6	167	6,6		F	173	6,6	172	6,8

**Steckergehäuse,
Griff mit flachem Profil**

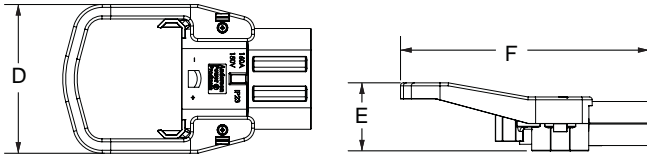

**Steckergehäuse,
Griff mit hohem Profil**

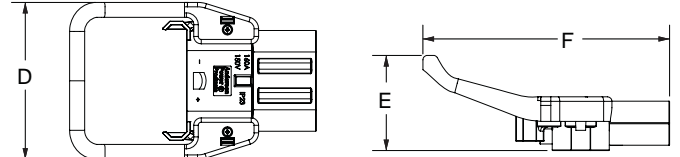

**Buchsengehäuse,
Griff mit flachem Profil**

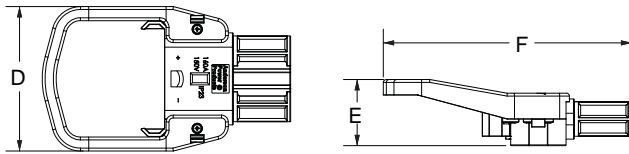

**Buchsengehäuse,
Griff mit hohem Profil**

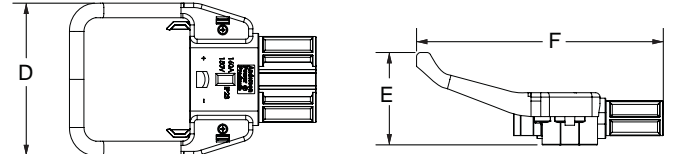

EBC 320-Griffe

		Flaches Profil		Hohes Profil				Flaches Profil		Hohes Profil	
		mm	Zoll	mm	Zoll			mm	Zoll	mm	Zoll
Steckergehäuse	D	101	4,0	106	4,2	Buchsengehäuse	D	101	4,0	106	4,2
	E	54	2,1	72	2,8		E	53	2,1	71	2,8
	F	175	6,9	174	6,9		F	71	2,8	173	6,8

**Steckergehäuse,
Griff mit flachem Profil**

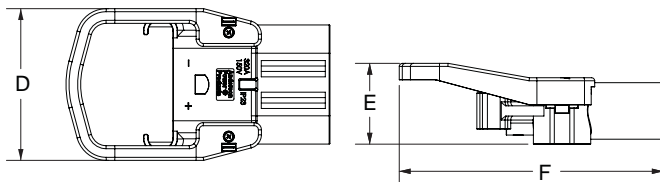

**Steckergehäuse,
Griff mit hohem Profil**

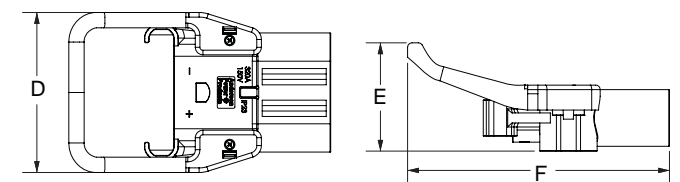

**Buchsengehäuse,
Griff mit flachem Profil**

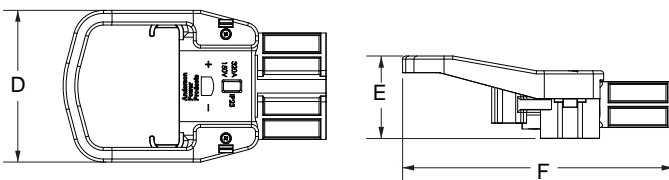

**Buchsengehäuse,
Griff mit hohem Profil**

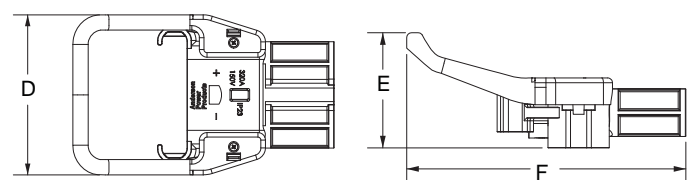

Steckzunge 160 & 320
Artikelnummer: A320-LP

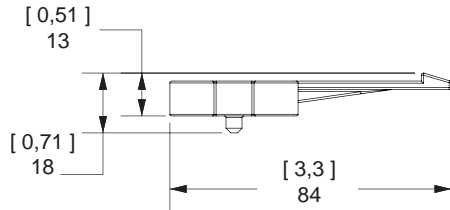
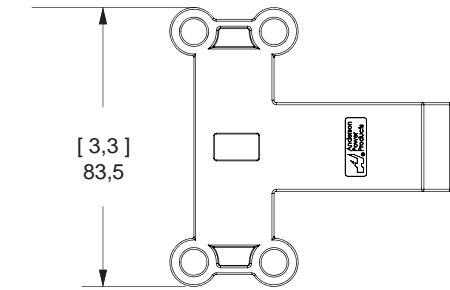

Steckzunge auf
EBC 160 & 320-Steckergehäuse

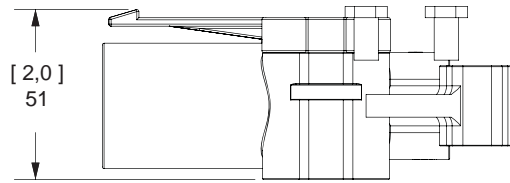

Griff- und Hebelmontage auf
Buchsengehäuse von EBC 160 & 320
Artikelnummer: A320HL

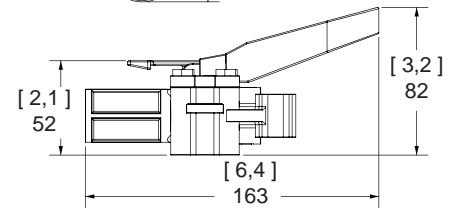
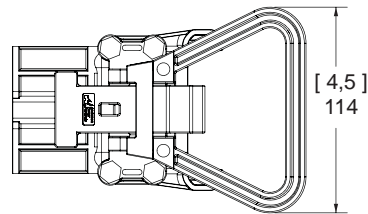

Manuelle Entriegelung für EBC 160 & 320
Artikelnummer: 994G4

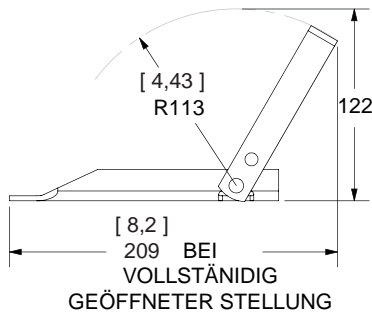
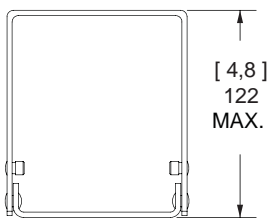
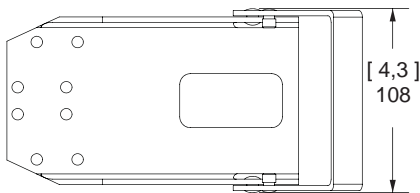

Batteriehalterung
Artikelnummer: 993G4

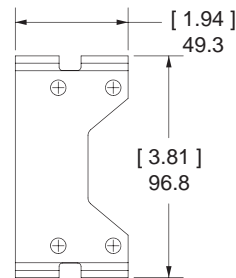

Manuelle Entriegelung mit Steckern

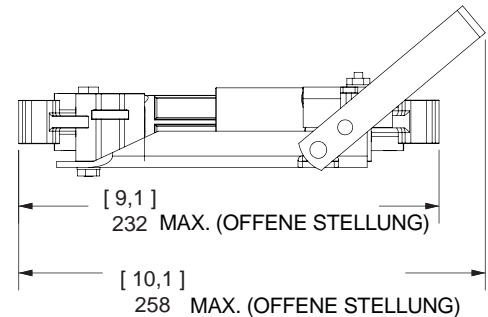
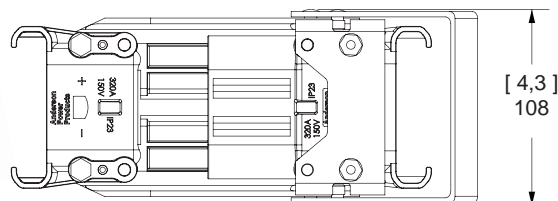

Kontakte						
Serie	Kabelquerschnitt		Flaches Profil		Hohes Profil	
	Metrisch	AWG	mm	Zoll	mm	Zoll
EBC 80	10 mm ²	Nr. 6 bis 8	6,0	0,24	4,5	0,18
EBC 80 / 160	16 mm ²	Nr. 4 bis 6	8,4	0,33	6,0	0,24
	25 mm ²	Nr. 2 bis 4	11,0	0,43	8,0	0,31
	35 mm ²	Nr. 1 bis 2	12,5	0,49	9,0	0,35
EBC 160 / 320	50 mm ²	Nr. 1 bis 1/0	14,5	0,57	11,0	0,43
EBC 320	70 mm ²	Nr. 2/0 bis 3/0	17,0	0,67	13,0	0,51
	95 mm ²	Nr. 3/0 bis 4/0	19,8	0,78	15,0	0,59



Stromkontaktstecker

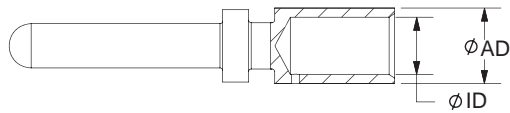

Stromkontaktbuchse

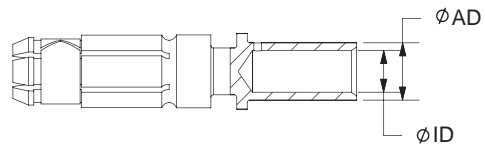

Obere Hilfsstecker							Untere Führungs-/Hilfsstecker					
Serie	Kabelquerschnitt		AD		ID		Kabelquerschnitt	AD		ID		
	mm ²	AWG	mm	Zoll	mm	Zoll		mm ²	AWG	mm	Zoll	mm
EBC 80	2,5	Nr. 14 bis 18	3,9	0,15	2,2	0,09	2,5	Nr. 14 bis 18	3,9	0,15	2,2	0,09
EBC 160 / 320	4	Nr. 12	4,1	0,16	2,9	0,11	6,0	Nr. 10	5,0	0,20	3,9	0,15

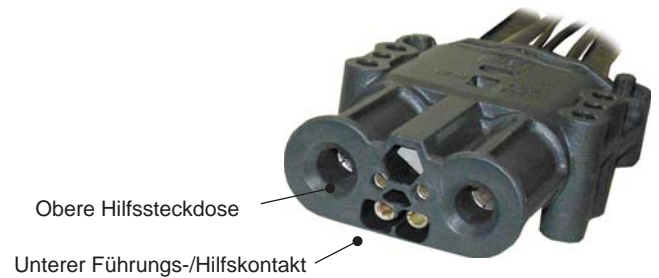

Oberer Hilfsstecker

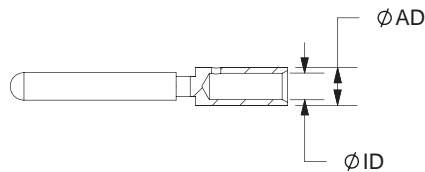

Oberer Hilfsbuchse

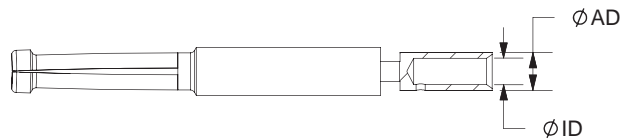

Unterer Führungs-/Hilfsstecker

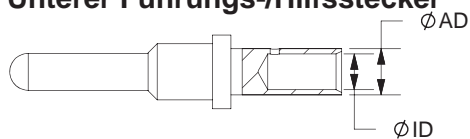

Untere Führungs-/Hilfsbuchse

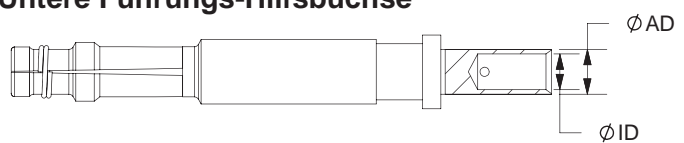

Gehäuse-Zwillingsluftadapter							Stecker-Zwillingsluftadapter					
Serie	G		H		J		G		H		J	
	mm	Zoll	mm	Zoll	mm	Zoll	mm	Zoll	mm	Zoll	mm	Zoll
EBC 80	102	4,0	15,8	0,62	13,0	0,51	87	3,4	15,8	0,62	13,0	0,51
EBC 160 / 320	154	6,1	17,8	0,70	13,9	0,55	125	4,9	17,8	0,70	14,0	0,55

Gehäuse-Luftadapter

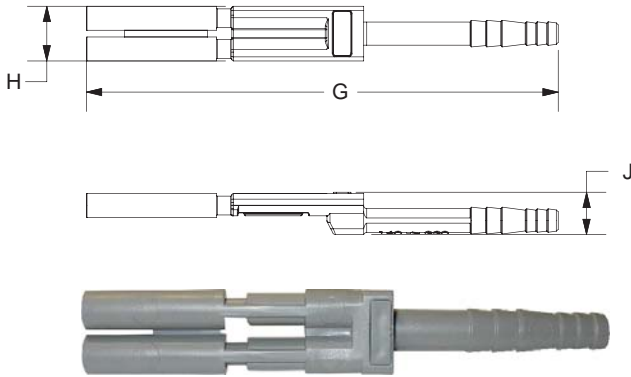

Stecker-Luftadapter

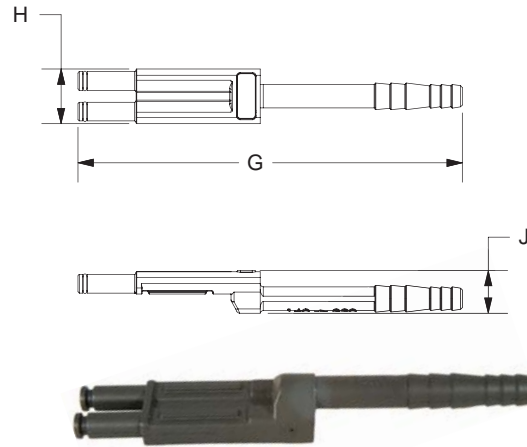

Spannungscodierstift für Nass-/Trockenzellen					Universeller Spannungscodierstift			
Serie	K		L		K		L	
	mm	Zoll	mm	Zoll	mm	Zoll	mm	Zoll
EBC 80	8,0	0,31	45	1,77	8,0	0,31	46	1,8
EBC 160 / 320	9,3	0,37	69	2,72	11,8	0,46	69	2,7

Spannungscodierstift für Nass-/Trockenzelle – Grau oder Grün

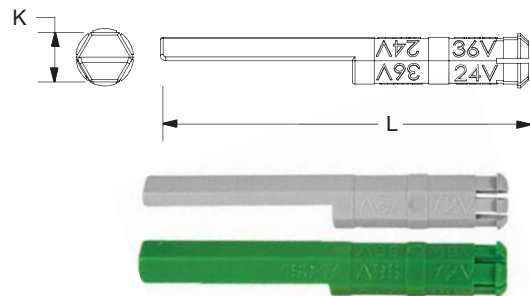

Codierstecker	Identifikation	Montiert in
	Verwendet für Nasszellenbatterie/ Ladegerät – Farbe Grau	Batterieanschlussbuchse und Ladestecker
	Verwendet für Trockenzellenbatterie/ Ladegerät – Farbe Grün	Batterieanschlussbuchse und Ladestecker
	Nur für Fahrzeug – Gelb (Universell)	Nur Fahrzeugstecker – wird verwendet, wenn im Fahrzeug Nass- oder Trockenzellenbatterien eingesetzt werden können.

Universeller Spannungscodierstift – Gelb (Verwendung nur mit Steckergehäuse)

Universelle (gelbe) Spannungscodierstift dürfen nur auf der Fahrzeugseite verwendet werden, um die Verwendung mit Trocken- und Nasszellenbatterien zu ermöglichen.

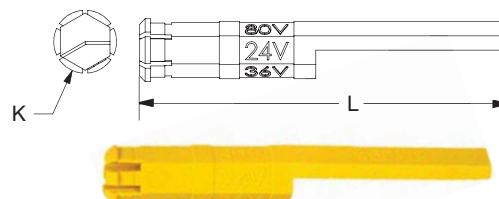

Werkzeuginformationen

EBC 80A, 160A, & 320A (DIN) – Pneumatische Werkzeuge												
Kabelquerschnitt		Teilenummern		Crimpwerkzeuge für lose Kontakte								
mm ²	AWG	Stromkontakt	Pneumatisches Tischwerkzeug	+	DIE	+	Locator (Einzel-Crimp)					
10 mm ²	Nr. 8 bis Nr. 6	80-1010 80-1110	Noch offen		Noch offen		Noch offen					
16 mm ²	Nr. 6 bis Nr. 4	80-1016 80-1116										
25 mm ²	Nr. 4 bis Nr. 2	80-1025 80-1125										
35 mm ²	Nr. 2 bis Nr. 1	80-1035 80-1135										
mm ²	AWG	Stromkontakt						Pneumatisches Tischwerkzeug	+	Die	+	Locator (Doppel-Crimp)
16 mm ²	Nr. 6 bis Nr. 4	160-1016 160-1116						1387G2		1303G14		1304G21 Buchse 1304G20 Stecker
25 mm ²	Nr. 4 bis Nr. 2	160-1025 160-1125								1303G13		
35 mm ²	Nr. 2 bis Nr. 1	160-1035 160-1135								1303G8		
50 mm ²	Nr. 1 bis 1/0	160-1050 160-1150	1303G8	1304G29 Stecker								
50 mm ²	Nr. 1 bis 1/0 AWG	320-1050 320-1150	1303G11									
70 mm ²	2/0 AWG bis 3/0 AWG	320-1070 320-1170	1303G3		1304G18 Buchse							
95 mm ²	3/0 AWG bis 4/0 AWG	320-1095 320-1195										
Führungs-/Hilfskontakte												
ALLE		Alle Crimpstecker Alle Crimpbuchsen	NUR LÖTMASCHINE									



1387G1 & 1387G2



1370G1 & 1387G3

EBC 80A, 160A, & 320A (DIN) – Hydraulische Werkzeuge								
Kabelquerschnitt		Teilenummern		Crimpwerkzeuge für lose Kontakte				
mm ²	AWG	Stromkontakt	Hydraulisches Handwerkzeug	+	DIE	ODER	Hydraulisches Handwerkzeug	
10 mm ²	Nr. 8 bis Nr. 6	80-1010 80-1110	1387G3 ODER 1370G1		1322G16		N/V	
	Nr. 6 bis	80-1016 80-1116			1322G9			
16 mm ²		80-1016 80-1116			1322G10			
25 mm ²	Nr. 4 bis Nr. 2	80-1025 80-1125			1322G15			
35 mm ²	Nr. 2 bis Nr. 1	80-1035 80-1135	N/V		N/V			
16 mm ²	Nr. 6 bis Nr. 4	160-1016 160-1116	1387G2		1322G9		1368 Serie	
25 mm ²	Nr. 4 bis Nr. 2	160-1025 160-1125			1322G12			
35 mm ²	Nr. 2 bis Nr. 1	160-1035 160-1135			1322G7			
50 mm ²	1/0 AWG	160-1050 160-1150			1322G4			
50 mm ²	Nr. 1 bis 1/0 AWG	320-1050 320-1150			1322G4			1322G3 (K)* 1322G2
70 mm ²	2/0 AWG bis 3/0 AWG	320-1070 320-1170						
95 mm ²	3/0 AWG bis 4/0 AWG	320-1095 320-1195			1322G1			
Führungs-/Hilfskontakte								
ALLE		Stecker Buchsen	NUR LÖTMASCHINE					



1368



1368-NL



1368-B

* 1322G3 nur mit K-Litze verwenden.

ADDITIONAL PRODUCTS FOR INDUSTRIAL VEHICLES



SBE®320 & SBX®350 - up to 550 Amps

- Touch Safe
- EN1175-1
- Up to 8 Auxiliaries



SB® - up to 450 Amps

- Genderless Housings
- Hot Plugging AC or DC
- Keyed Housings



SBS®75X - up to 110 Amps

- Wire-to-Wire / Wire-to-Board
- Touch Safe Interface
- Ground or Auxiliary Positions



HEADQUARTERS

Anderson Power Products®
13 Pratts Junction Road
Sterling, MA 01564-2305 USA
T: 978-422-3600
F: 978-422-0128

EUROPE

Anderson Power Products® Ltd.
Unit 3 Europa Court
Europa Boulevard
Westbrook, Warrington
Cheshire, WA5 7TN United Kingdom
T: +44 (0) 1925 428390
F: +44 (0) 1925 520203

ASIA / PACIFIC

IDEAL Anderson Asia Pacific Ltd.
Unit 922-928, Topsail Plaza
11 On Sum Street
Shatin N.T., Hong Kong
T: +(852) 2636 0836
F: +(852) 2635 9036

CHINA

IDEAL Anderson Technologies (Shenzhen) Ltd.
Block A8, Tantou Western Industrial Park
Songgang, Baoan District
Shenzhen, P.R. China 518105
T: +(86) 755 2768 2118/3393 2388
F: +(86) 755 2768 2218

TAIWAN

IDEAL Anderson Asia Pacific Ltd.
Taiwan Branch, 4F-2, No.116
Dadun 20th St., Situn District
Taichung City 407, Taiwan (R.O.C.)
T: +(886) 4 2310 6451
F: +(886) 4 2310 6460

