



AMP | AMP Twin-Leaf

TE Internal #: 583853-3

Socket Contact, Gold, Locking Lance Contact Retention, 24 – 20
AWG Wire Size, .2 – .6 mm² Wire Size, 404 – 1020 CMA Wire Size,
Crimp, AMP Twin-Leaf

[View on TE.com >](#)

Connectors > Contacts > Connector Contacts

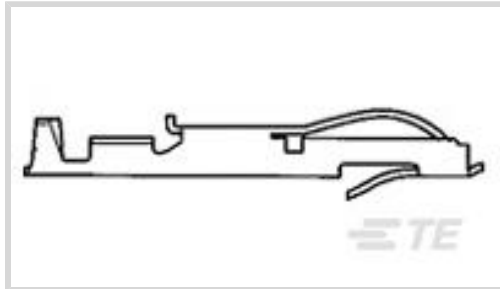
Contact Type: **Socket**Contact Mating Area Plating Material: **Gold**Wire Contact Termination Area Plating Material: **Tin-Lead**Contact Retention Within Housing: **With**Contact Retention Type Within Housing: **Locking Lance****Features****Contact Features**

PCB Contact Termination Area Plating Material	Nickel
Contact Type	Socket
Contact Mating Area Plating Material	Gold
Wire Contact Termination Area Plating Material	Tin-Lead
Contact Retention Within Housing	With
Contact Base Material	Phosphor Bronze
Contact Current Rating (Max)	5 A

Termination Features

Termination Method to Wire & Cable	Crimp
Product Terminates To	Wire & Cable

Mechanical Attachment

Contact Retention Type Within Housing	Locking Lance
---------------------------------------	---------------

Dimensions

Compatible Insulation Diameter Range	1.22 – 1.52 mm [.048 – .06 in]
Wire Size	404 – 1020 CMA

Usage Conditions

Operating Temperature Range	-40 – 85 °C [-40 – 185 °F]
-----------------------------	----------------------------

Operation/Application



Circuit Application	Power & Signal
---------------------	----------------

Identification Marking

Contact Color Code	Green
--------------------	-------

Packaging Features

Packaging Quantity	7000
--------------------	------

Packaging Method	Strip
------------------	-------

Product Compliance

[For compliance documentation, visit the product page on TE.com>](#)

EU RoHS Directive 2011/65/EU	Not Compliant
------------------------------	---------------

EU ELV Directive 2000/53/EC	Compliant with Exemptions
-----------------------------	---------------------------

China RoHS 2 Directive MIIT Order No 32, 2016	Restricted Materials Above Threshold
---	--------------------------------------

EU REACH Regulation (EC) No. 1907/2006	<p>Current ECHA Candidate List: JUNE 2024 (241)</p> <p>Candidate List Declared Against: JUNE 2024 (241)</p> <p>SVHC > Threshold:</p> <p>Pb (13% in Component Part)</p>
--	---

Article Safe Usage Statements:
Do not eat, drink or smoke when using this product. Wash thoroughly after handling. Recycle if possible and dispose of the article by following all applicable governmental regulations relevant to your geographic location.

Halogen Content	Low Halogen - Br, Cl, F, I < 900 ppm per homogenous material. Also BFR/CFR/PVC Free
-----------------	---

Solder Process Capability	Not applicable for solder process capability
---------------------------	--

Product Compliance Disclaimer

This information is provided based on reasonable inquiry of our suppliers and represents our current actual knowledge based on the information they provided. This information is subject to change. The part numbers that TE has identified as EU RoHS compliant have a maximum concentration of 0.1% by weight in homogenous materials for lead, hexavalent chromium, mercury, PBB, PBDE, DBP, BBP, DEHP, DIBP, and 0.01% for cadmium, or qualify for an exemption to these limits as defined in the Annexes of Directive 2011/65/EU (RoHS2). Finished electrical and electronic equipment products will be CE marked as required by Directive 2011/65/EU. Components may not be CE marked. Additionally, the part numbers that TE has identified as EU ELV compliant have a maximum concentration of 0.1% by weight in homogenous materials for lead, hexavalent chromium, and mercury, and 0.01% for cadmium, or qualify for an exemption to these limits as defined in the Annexes of Directive 2000/53/EC (ELV). Regarding the REACH Regulation, the information TE provides on SVHC in articles for this part number is based on the latest European Chemicals Agency (ECHA) 'Guidance on requirements for substances in articles' posted at this URL: <https://echa.europa.eu/guidance-documents/guidance-on-reach>

Compatible Parts

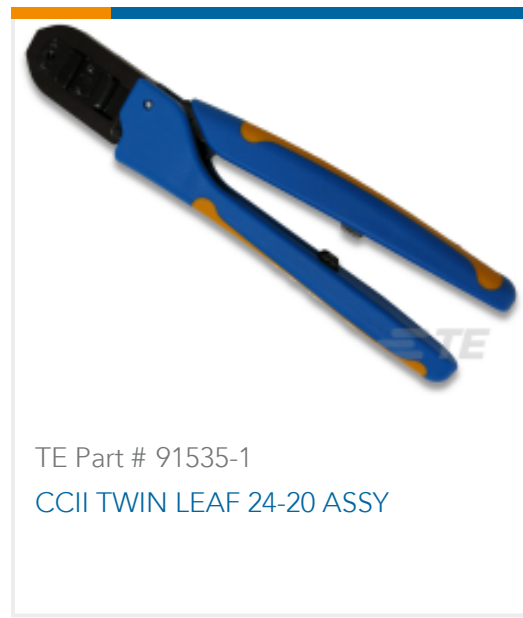
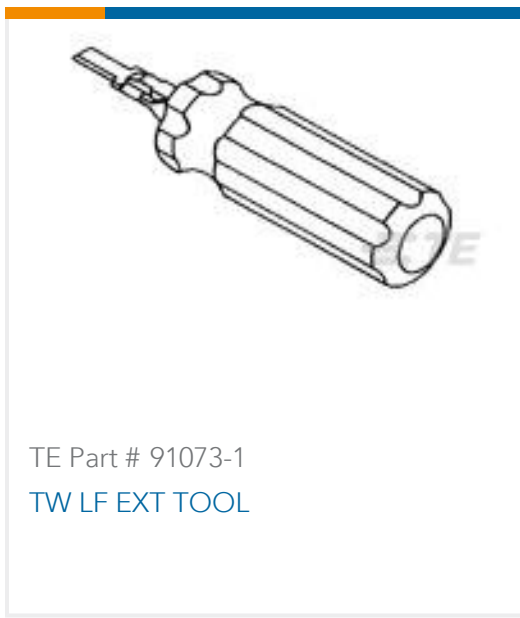

Also in the Series | AMP Twin-Leaf

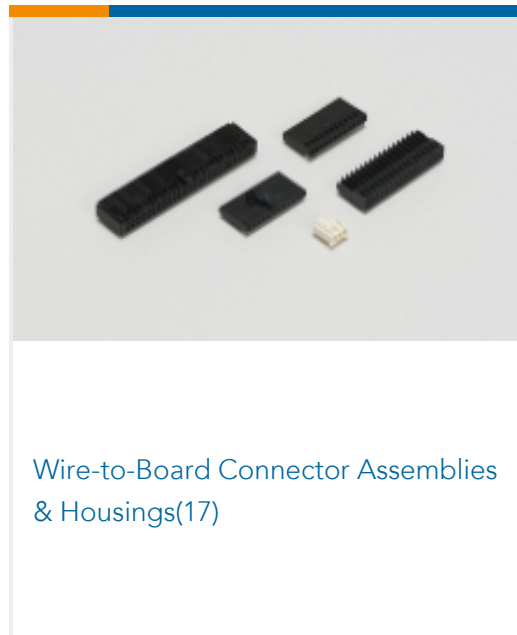
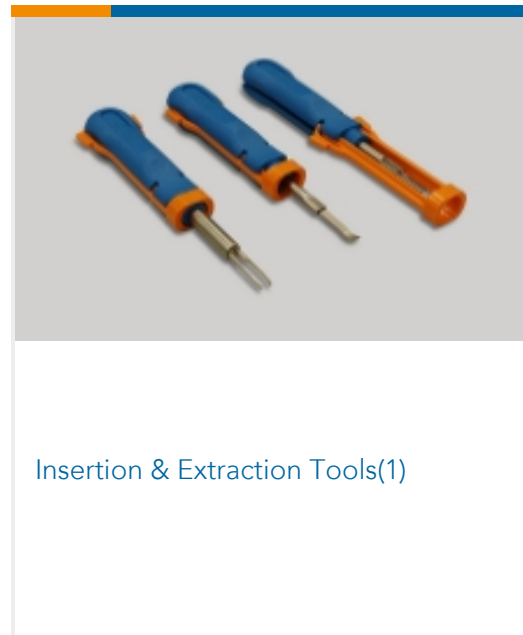
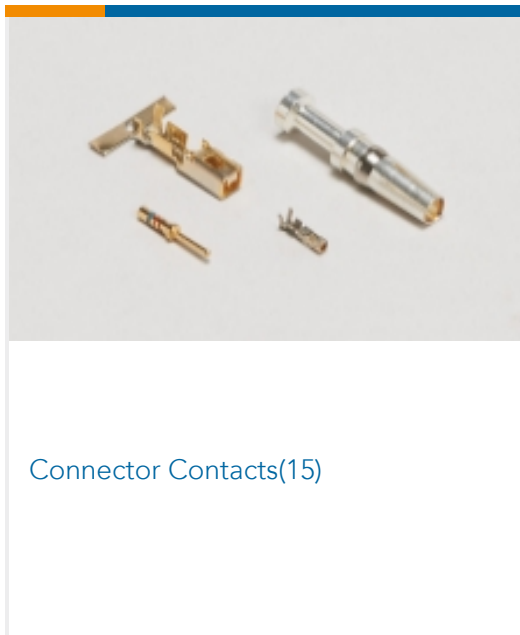

Customers Also Bought

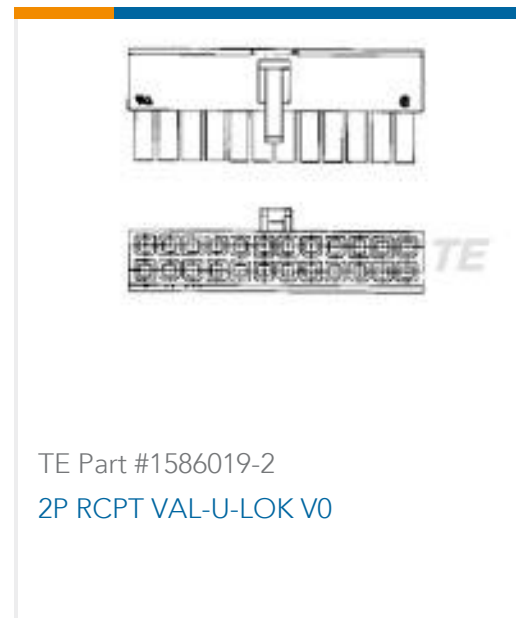

Documents

Product Drawings

TWIN LEAF TERM. STRIP CSTL

English

CAD Files

3D PDF

3D



Customer View Model

[ENG_CVM_CVM_583853-3_BR.2d_dxf.zip](#)

English

Customer View Model

[ENG_CVM_CVM_583853-3_BR.3d_igs.zip](#)

English

Customer View Model

[ENG_CVM_CVM_583853-3_BR.3d_stp.zip](#)

English

Customer View Model

[ENG_CVM_583853-3_V1.3d_igs.zip](#)

English

Customer View Model

[ENG_CVM_583853-3_V1.3d_stp.zip](#)

English

3D PDF

English

Customer View Model

[ENG_CVM_583853-3_V1.2d_dxf.zip](#)

English

By downloading the CAD file I accept and agree to the [Terms and Conditions](#) of use.

Product Specifications

[Application Specification](#)

English