

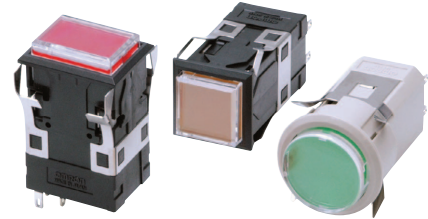

## Large Rectangular-bodied Indicators

- Excellent illumination with even surface brightness.
- Three-color models (green, orange, red; chameleon lighting) included in lineup.



 Refer to *Safety Precautions for All Pushbutton Switches/ Indicators* and *Safety Precautions of A3P*.

### List of Models

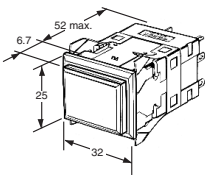
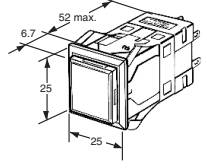
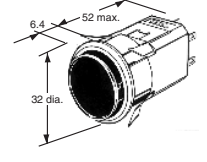
| Model                 | Appearance  |
|-----------------------|---|
| M2PJ<br>(Rectangular) |   |
| M2PA<br>(Square)      |  |
| M2PT<br>(Round)       |  |

■ Panel cutout dimensions: Refer to page 12.      ■ Dimensions: Refer to page 11.  
 ■ Accessories, replacements, and tools: Refer to the A3P.      ■ Specifications: Refer to the A3P.

## Model Number Structure

**Model Number Legend** ..... The model numbers used to order sets of Units are illustrated below. One set comprises the Display, Lamp, and Socket.

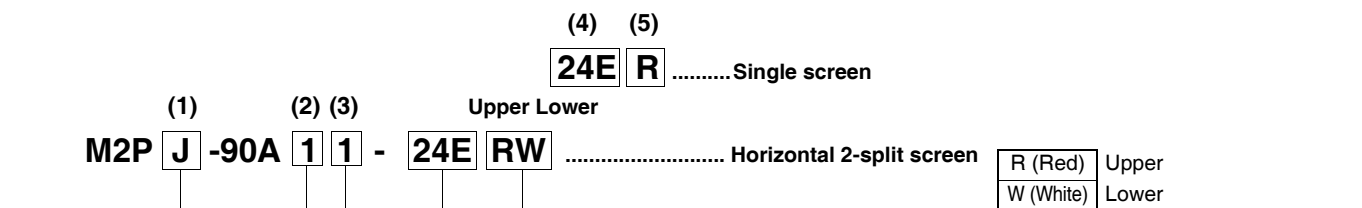

For information on combinations, refer to *Ordering Information*.



### (1) Shape of Display

| Symbol | Shape       |
|--------|-------------|
| J      | Rectangular |
| A      | Square      |
| T      | Round       |

### (2) Screen Pattern

| Illumination-only models |   |
|--------------------------|---|
| Symbol                   | Screen pattern  |
| 1                        | Single screen<br>  |
| 2                        | 2-split screen<br>   |
| G                        | Chameleon *1<br><br>Note: The chameleon screen pattern is not available with M2PT models. The chameleon screen pattern is only available with 12 or 24-VDC models. |

\*1. With chameleon models, the whole screen lights red, green, or orange. When not lit, the display is white.

• The available rectangular models are shown below. Select from among the individual products shown on page 7.

Vertical 2-split screen models      4-split screen models



Horizontal 3-split screen models      Vertical 3-split screen models



The above diagrams show the Sockets with the "OMRON" mark facing down.

► Colored-illumination models up to the 4-split screen models are available as individual Units. Refer to page 7.

► "Colored-illumination" models operate in the way shown below:

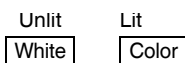

The built-in LED is colored.

### (3) Case Color

| Symbol | Color      |
|--------|------------|
| 1      | Black      |
| 2      | Light gray |

Note: M2PT model is available in light gray only.

### (4) Lighting Method LED-lighted Models (M2PJ and M2PA Only)

| Symbol | Rated voltage |
|--------|---------------|
| 05E    | 5 VDC         |
| 12E    | 12 VAC/VDC    |
| 24E    | 24 VAC/VDC    |

Note: DC rated voltage only for 2-split screen models.

### LED Lamp-lighted Models (M2PT Only)

| Symbol | Rated voltage |
|--------|---------------|
| 05C    | 5 VDC         |
| 12C    | 12 VDC        |
| 24C    | 24 VDC        |

Note: M2PJ and M2PA can also be ordered separately. Refer to page 7 for details.

### Incandescent Lamp lighted Models

| Symbol | Rated voltage |
|--------|---------------|
| 06     | 6 VAC/VDC     |
| 14     | 14 VAC/VDC    |
| 28     | 28 VAC/VDC    |

### (5) Color of Display For LED

| Symbol | Color     |
|--------|-----------|
| R      | Red       |
| O      | Orange    |
| G      | Green     |
| W      | White     |
| K      | Chameleon |

- The chameleon screen pattern is not available with M2PT models.
- The chameleon screen pattern is only available with 12 or 24-VDC models.

### For Incandescent Lamp

| Symbol    | Color                           |
|-----------|---------------------------------|
| No symbol | Red, Orange, White, Blue, Green |

- Includes colored plate. Refer to page 8 for details.
- (Low-power incandescent lamp)

### Number of Built-in LED Lamps

| Screen pattern            | A3PJ                | A3PA | A3PT |
|---------------------------|---------------------|------|------|
| Single screen             | Built-in LED models |      | 2    |
| Horizontal 2-split screen |                     |      | ---  |
| Vertical 2-split screen   |                     |      |      |
| Horizontal 3-split screen | 4 *2                | ---  | ---  |
| Vertical 3-split screen   |                     |      |      |
| 4-split screen            |                     |      |      |

### Number of Built-in Incandescent Lamps

| Screen pattern            | A3PJ                               | A3PA | A3PT |
|---------------------------|------------------------------------|------|------|
| Single screen             | 2                                  | 1    | 2    |
| Horizontal 2-split screen | 4 (Low-power incandescent lamp) *2 | 2    | ---  |
| Vertical 2-split screen   |                                    |      |      |
| 3-split, E shape/T shape  |                                    |      |      |
| 4-split screen            |                                    |      |      |

\*2. These split screen models are available only as individual Units. They cannot be ordered as sets.

## Ordering Information

**Ordering as a Set** ..... The model numbers used to order sets of Units are given in the following tables. One set comprises the Display, Lamp, and Socket.

### M2PJ (Rectangular) Single Screen Models

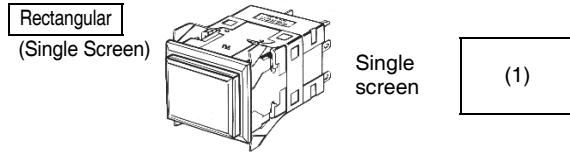

| Case color        |            | Black             | Light gray        | Display color symbol |
|-------------------|------------|-------------------|-------------------|----------------------|
| LED               | 5 VDC      | M2PJ-90A11-05E(1) | M2PJ-90A12-05E(1) | R<br>O<br>G<br>W     |
|                   | 12 VAC/VDC | M2PJ-90A11-12E(1) | M2PJ-90A12-12E(1) |                      |
|                   | 24 VAC/VDC | M2PJ-90A11-24E(1) | M2PJ-90A12-24E(1) |                      |
| Chameleon         | 12 VDC     | M2PJ-90AG1-12EK   | M2PJ-90AG2-12EK   | *1                   |
|                   | 24 VDC     | M2PJ-90AG1-24EK   | M2PJ-90AG2-24EK   |                      |
| Incandescent lamp | 6 VAC/VDC  | M2PJ-90A11-06     | M2PJ-90A12-06     | *2                   |
|                   | 14 VAC/VDC | M2PJ-90A11-14     | M2PJ-90A12-14     |                      |
|                   | 28 VAC/VDC | M2PJ-90A11-28     | M2PJ-90A12-28     |                      |

Note: Enter the desired color symbol for the Display in (1). (R) = Red, (O) = Orange, (G) = Green, (W) = White.

Example: Red M2PJ-90A11-24ER

\*1. You can change the screen colors of chameleon models between red, green, and orange by changing the terminal wiring. Refer to page 14 for details.

\*2. Incandescent lamps are supplied with colored plates (white, red, green, blue, and orange) and legend plates (milk-white and transparent). Use the appropriate combination.

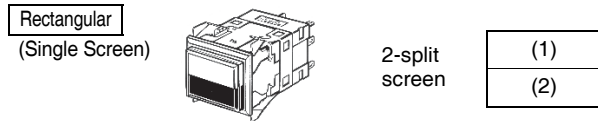

| Case color        |            | Black                | Light gray           | Display color symbol |
|-------------------|------------|----------------------|----------------------|----------------------|
| LED               | 24 VDC     | M2PJ-90A21-24E(1)(2) | M2PJ-90A22-24E(1)(2) | R O G W              |
| Incandescent lamp | 6 VAC/VDC  | M2PJ-90A21-06        | ---                  | *                    |
|                   | 14 VAC/VDC | M2PJ-90A21-14        | M2PJ-90A22-14        |                      |
|                   | 28 VAC/VDC | M2PJ-90A21-28        | M2PJ-90A22-28        |                      |

Note: Enter the desired color symbols for the Display in (1) and (2). (R) = Red, (O) = Orange, (G) = Green, (W) = White.

Example: Red Upper M2PJ-90A21-24ERW  
White Lower R W  
Red White

\* Incandescent lamps are supplied with colored plates (white, red, green, blue, and orange) and legend plates (milk-white and transparent). Use the appropriate combination.

Individual models: Refer to pages 6 to 8.  
(The Display, Lamp, and Socket can be ordered separately.)

■ Specifications: Refer to the A3P.  
 ■ Dimensions: Refer to page 11. Accessories: Refer to the A3P.

## Ordering Information

**Ordering as a Set** ..... The model numbers used to order sets of Units are given in the following tables. One set comprises the Display, Lamp, and Socket.

### M2PA (Square) Single Screen Models

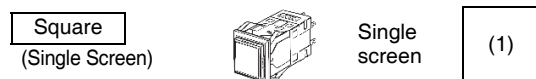

| Case color        |            | Black             | Light gray        | Display color symbol |
|-------------------|------------|-------------------|-------------------|----------------------|
| LED               | 5 VDC      | M2PA-90A11-05E(1) | M2PA-90A12-05E(1) | ROGW                 |
|                   | 12 VAC/VDC | M2PA-90A11-12E(1) | M2PA-90A12-12E(1) |                      |
|                   | 24 VAC/VDC | M2PA-90A11-24E(1) | M2PA-90A12-24E(1) |                      |
| Chameleon         | 12 VDC     | M2PA-90AG1-12EK   | ---               | *1                   |
|                   | 24 VDC     | M2PA-90AG1-24EK   | M2PA-90AG2-24EK   |                      |
| Incandescent lamp | 6 VAC/VDC  | M2PA-90A11-06     | M2PA-90A12-06     | *2                   |
|                   | 14 VAC/VDC | M2PA-90A11-14     | M2PA-90A12-14     |                      |
|                   | 28 VAC/VDC | M2PA-90A11-28     | M2PA-90A12-28     |                      |

Note: Enter the desired color symbol for the Display in (1). (R) = Red, (O) = Orange, (G) = Green, (W) = White.

Example: Red M2PA-90A11-24ER

\*1. You can change the screen colors of chameleon models between red, green, and orange, by changing the terminal wiring. Refer to page 14 for details.

\*2. Incandescent lamps are supplied with colored plates (white, red, green, blue, and orange) and legend plates (milk-white and transparent). Use the appropriate combination.

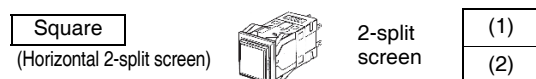

| Case color        |            | Black                | Light gray           | Display color symbol |
|-------------------|------------|----------------------|----------------------|----------------------|
| LED               | 24 VDC     | M2PA-90A21-24E(1)(2) | M2PA-90A22-24E(1)(2) | ROGW                 |
| Incandescent lamp | 6 VAC/VDC  | M2PA-90A21-06        | M2PA-90A22-06        | *                    |
|                   | 14 VAC/VDC | M2PA-90A21-14        | M2PA-90A22-14        |                      |
|                   | 28 VAC/VDC | M2PA-90A21-28        | M2PA-90A22-28        |                      |

Note: Enter the desired color symbols for the Display in (1) and (2). (R) = Red, (O) = Orange, (G) = Green, (W) = White.

Example: Red Upper M2PA-90D21-24ERW  
White Lower Red White

\* Incandescent lamps are supplied with colored plates (white, red, green, blue, and orange) and legend plates (milk-white and transparent). Use the appropriate combination.

### M2PT (Round) Single Screen Models



| Case color        |            | Light gray        | Display color symbol |
|-------------------|------------|-------------------|----------------------|
| LED lamp          | 5 VDC      | M2PT-90A12-05C(1) | ROGW                 |
|                   | 12 VDC     | M2PT-90A12-12C(1) |                      |
|                   | 24 VDC     | M2PT-90A12-24C(1) |                      |
| Incandescent lamp | 28 VAC/VDC | M2PT-90A12-28     | *                    |

Note: Enter the desired color symbol for the Display in (1). (R) = Red, (O) = Orange, (G) = Green, (W) = White.

Example: Red M2PT-90A12-24CR

\* Incandescent lamps are supplied with a colored plates (white, red, green, blue, and orange). Use the appropriate combination. Models A3PT and M2PT (round models), however, are not supplied with legend plates.

Individual models: Refer to pages 6 to 8.  
(The Display, Lamp, and Socket can be ordered separately.)

■ Specifications: Refer to the A3P.  
■ Dimensions: Refer to page 11. Accessories: Refer to the A3P.

## Ordering Information

### Illumination-only and Colored-illumination LED Models

“Illumination only” describes LED models for which the screen color is the same whether the LED is lit or not. The screen simply becomes brighter when the LED lights.

#### Example: Red LED

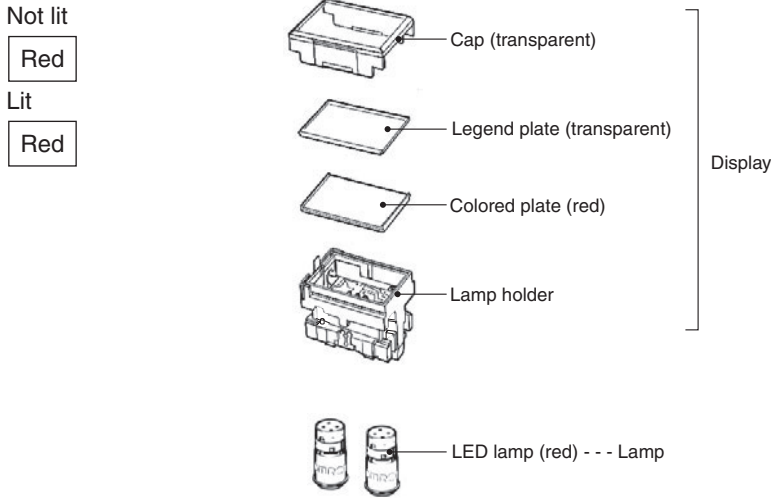

“Colored illumination” describes LED models for which the screen color is white when the LED is not lit and changes to the color of the LED lamp when the LED is lit.

#### Example: Red LED

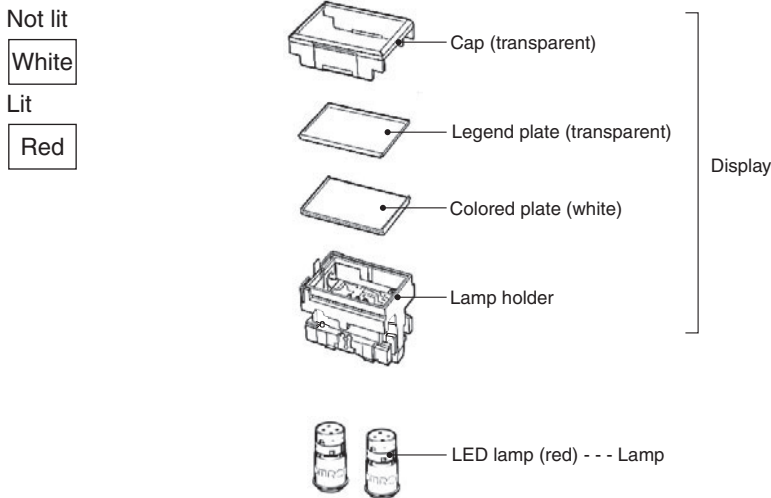

**Ordering:** For a colored-illumination Indicator, order the Display, Lamp, and Socket as shown in the following table.

| Display  | Lamp   | Socket   |
|--|--|--|
| <ul style="list-style-type: none"> <li>Select the LED lamp-lighted model required from the selection on page 7. Each assembly includes the number of white colored plates required to enable colored illumination for the corresponding screen-split configuration. For example, 4-split screen models includes 4 white colored plates.</li> </ul> | <ul style="list-style-type: none"> <li>Select the LED lamps to suit your desired coloration from the selection on page 8.</li> <li>Number of necessary LED lamps (standard):<br/>M2PJ (rectangular): 4<br/>M2PA (square): 2<br/>M2PT (round): 2</li> </ul> | <ul style="list-style-type: none"> <li>Select from the Sockets on page 8.</li> </ul> |

## Ordering Information

**Ordering Individually** ..... Displays, Lamps, and Sockets can be ordered separately. Combinations that are not available as sets can be created using individual Units. Also, store the parts as spares for maintenance and repairs.

### LED-lighted/Chameleon Models (LED is built into the Display.)

**Display**

Round (M2PT) models not available.

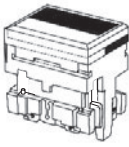

- M2P□-5□□□-□□E  
(for Indicator)

### LED Lamp-lighted Models (LED lamp and Display are separate.)

**Display**

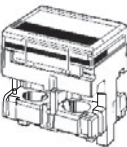

- M2P□-502□  
(for Indicator)

### Incandescent Lamp-lighted Models (Incandescent lamp and Display are separate.)

**Display**

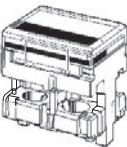

- M2P□-501□  
(for Indicator)



**Lamp (LED Lamp) \*1**



SLL-□□E□

**Lamp (Incandescent Lamp) \*2**



- Standard lamp: SLL-□□
- Low-power lamp: SLL-□□H



**Socket \***

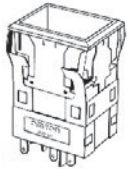

- M2P□-7□□□-□  
(for Indicator)

**Socket \***

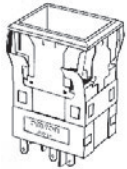

- M2P□-7□□□-□  
(for Indicator)

**Socket \***

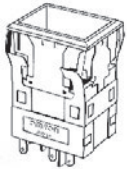

- M2P□-7□□□-□  
(for Indicator)

\* The Socket is compatible with LED-lighted, LED lamp-lighted, and incandescent lamp-lighted models.

\*1. Number of necessary LED lamps.

| Screen pattern            | M2PJ | M2PA | M2PT |
|---------------------------|------|------|------|
| Single screen             | 4    | 2    | 2    |
| Horizontal 2-split screen |      | 2    | ---  |
| Vertical 2-split screen   |      | ---  | ---  |
| Vertical 3-split screen   |      | ---  | ---  |
| Horizontal 3-split screen |      | ---  | ---  |
| 4-split screen            |      | ---  | ---  |

\*2. Number of necessary incandescent lamps.

| Screen pattern            | M2PJ                               | M2PA | M2PT |
|---------------------------|------------------------------------|------|------|
| Single screen             | 2                                  | 1    | 2    |
| Horizontal 2-split screen | 4<br>(low-power incandescent lamp) | 2    | ---  |
| Vertical 2-split screen   |                                    | ---  | ---  |
| Vertical 3-split screen   |                                    | ---  | ---  |
| Horizontal 3-split screen |                                    | ---  | ---  |
| 4-split screen            |                                    | ---  | ---  |

Ordering set combinations: Refer to pages 3 to 4.





■ Specifications: Refer to the A3P.  
■ Dimensions: Refer to page 11. Accessories: Refer to the A3P.

## Ordering Information

**Ordering Individually** .....Displays, Lamps, and Sockets can be ordered separately. Combinations that are not available as sets can be created using individual Units. Also, store the parts as spares for maintenance and repairs.

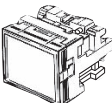

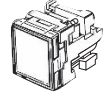





Display

### LED-lighted Models (LED is built-in.)

| Appearance  | Split-screen color (color symbol) | White (W)   | Red (R)       | Green (G)     | Orange (O)    | Selection precautions |   |
|---|-----------------------------------|---|---------------|---------------|---------------|-----------------------|---|
| Rectangular models<br> | Single screen                     |  | M2PJ-5701-□□E | M2PJ-5702-□□E | M2PJ-5703-□□E | M2PJ-5706-□□E         | <ul style="list-style-type: none"> <li>Enter the voltage to be used in the □□ at the end of the model number.<br/>Examples of voltage used:<br/>5 V=0 5 E<br/>12 V=1 2 E<br/>24 V=2 4 E</li> <li>Horizontal 2-split screen models support only 24V.</li> <li>For the color of the shaded part, select the model according to the colors given at the top of the table.</li> </ul> |
|   | Horizontal 2- 2 split screen      | White   | M2PJ-5711-□□E | M2PJ-5712-□□E | M2PJ-5713-□□E | M2PJ-5716-□□E         |   |
|   |                                   | Red   | M2PJ-5721-□□E | M2PJ-5722-□□E | M2PJ-5723-□□E | M2PJ-5726-□□E         |   |
|   |                                   | Green   | M2PJ-5731-□□E | M2PJ-5732-□□E | M2PJ-5733-□□E | M2PJ-5736-□□E         |   |
|   |                                   | Orange  | M2PJ-5741-□□E | M2PJ-5742-□□E | M2PJ-5743-□□E | M2PJ-5746-□□E         |   |
| Square models<br>      | Single screen                     |  | M2PA-5701-□□E | M2PA-5702-□□E | M2PA-5703-□□E | M2PA-5706-□□E         |   |
|   | Horizontal 2-split screen         | White   | M2PA-5711-□□E | M2PA-5712-□□E | M2PA-5713-□□E | M2PA-5716-□□E         |   |
|   |                                   | Red   | M2PA-5721-□□E | M2PA-5722-□□E | M2PA-5723-□□E | M2PA-5726-□□E         |   |
|   |                                   | Green   | M2PA-5731-□□E | M2PA-5732-□□E | M2PA-5733-□□E | M2PA-5736-□□E         |   |
|   |                                   | Orange  | M2PA-5741-□□E | M2PA-5742-□□E | M2PA-5743-□□E | M2PA-5746-□□E         |   |

Note: 1. A cap, legend plate (transparent), colored plate, white plunger case, and LED (with a current-limiting resistor) are built into the standard lighting unit.  
2. Split-screen coloring configurations are given with the "OMRON" mark on the Sockets facing down.

### LED Lamp-lighted Models (LED is not built-in.)

| Model                     | Rectangular models  | Square models | Round models  | Selection precautions |   |           |  |                |       |     |       |        |               |   |   |   |   |                           |   |   |   |   |                           |   |   |   |   |                           |   |   |   |   |                |   |   |   |   |
|---------------------------|---|---------------|---|-----------------------|---|-----------|--|----------------|-------|-----|-------|--------|---------------|---|---|---|---|---------------------------|---|---|---|---|---------------------------|---|---|---|---|---------------------------|---|---|---|---|----------------|---|---|---|---|
| Screen pattern            | Screen  | Model         | Screen  | Model                 | Screen  | Model     |  |                |       |     |       |        |               |   |   |   |   |                           |   |   |   |   |                           |   |   |   |   |                           |   |   |   |   |                |   |   |   |   |
| Single screen             |  | M2PJ-5021     |  | M2PA-5021             |  | M2PT-5021 | <ul style="list-style-type: none"> <li>Colored plates (white, red, green, and orange), a legend plate (transparent), and a light baffle (split-screen models only) are included. Use the appropriate combination for the LED coloring required.</li> <li>The number of white colored plates required to enable colored illumination for the corresponding screen-split configuration is included. (For example, 4-split screen models include 4 white colored plates).</li> <li>The number of colored plates included for each model are shown in the following table.</li> </ul> <table border="1"> <thead> <tr> <th>Screen pattern</th> <th>White</th> <th>Red</th> <th>Green</th> <th>Orange</th> </tr> </thead> <tbody> <tr> <td>Single screen</td> <td>1</td> <td>1</td> <td>1</td> <td>1</td> </tr> <tr> <td>Horizontal 2-split screen</td> <td>2</td> <td>1</td> <td>1</td> <td>1</td> </tr> <tr> <td>Horizontal 3-split screen</td> <td>3</td> <td>2</td> <td>2</td> <td>2</td> </tr> <tr> <td>Vertical 3-split screen *</td> <td>3</td> <td>2</td> <td>2</td> <td>2</td> </tr> <tr> <td>4-split screen</td> <td>4</td> <td>1</td> <td>1</td> <td>1</td> </tr> </tbody> </table> | Screen pattern | White | Red | Green | Orange | Single screen | 1 | 1 | 1 | 1 | Horizontal 2-split screen | 2 | 1 | 1 | 1 | Horizontal 3-split screen | 3 | 2 | 2 | 2 | Vertical 3-split screen * | 3 | 2 | 2 | 2 | 4-split screen | 4 | 1 | 1 | 1 |
| Screen pattern            | White   | Red           | Green   | Orange                |   |           |  |                |       |     |       |        |               |   |   |   |   |                           |   |   |   |   |                           |   |   |   |   |                           |   |   |   |   |                |   |   |   |   |
| Single screen             | 1   | 1             | 1   | 1                     |   |           |  |                |       |     |       |        |               |   |   |   |   |                           |   |   |   |   |                           |   |   |   |   |                           |   |   |   |   |                |   |   |   |   |
| Horizontal 2-split screen | 2   | 1             | 1   | 1                     |   |           |  |                |       |     |       |        |               |   |   |   |   |                           |   |   |   |   |                           |   |   |   |   |                           |   |   |   |   |                |   |   |   |   |
| Horizontal 3-split screen | 3   | 2             | 2   | 2                     |   |           |  |                |       |     |       |        |               |   |   |   |   |                           |   |   |   |   |                           |   |   |   |   |                           |   |   |   |   |                |   |   |   |   |
| Vertical 3-split screen * | 3   | 2             | 2   | 2                     |   |           |  |                |       |     |       |        |               |   |   |   |   |                           |   |   |   |   |                           |   |   |   |   |                           |   |   |   |   |                |   |   |   |   |
| 4-split screen            | 4   | 1             | 1   | 1                     |   |           |  |                |       |     |       |        |               |   |   |   |   |                           |   |   |   |   |                           |   |   |   |   |                           |   |   |   |   |                |   |   |   |   |
| Horizontal 2-split screen |  | M2PJ-5022     |  | M2PA-5022             |   | ---       |  |                |       |     |       |        |               |   |   |   |   |                           |   |   |   |   |                           |   |   |   |   |                           |   |   |   |   |                |   |   |   |   |
| Vertical 2-split screen   |  | M2PJ-5023     |   | ---                   |   | ---       |  |                |       |     |       |        |               |   |   |   |   |                           |   |   |   |   |                           |   |   |   |   |                           |   |   |   |   |                |   |   |   |   |
| Horizontal 3-split screen |  | M2PJ-5024     |   | ---                   |   | ---       |  |                |       |     |       |        |               |   |   |   |   |                           |   |   |   |   |                           |   |   |   |   |                           |   |   |   |   |                |   |   |   |   |
| Vertical 3-split screen   |  | M2PJ-5025     |   | ---                   |   | ---       |  |                |       |     |       |        |               |   |   |   |   |                           |   |   |   |   |                           |   |   |   |   |                           |   |   |   |   |                |   |   |   |   |
| 4-split screen            |  | M2PJ-5026     |   | ---                   |   | ---       |  |                |       |     |       |        |               |   |   |   |   |                           |   |   |   |   |                           |   |   |   |   |                           |   |   |   |   |                |   |   |   |   |

\* The following types of colored plates are included with Horizontal and Vertical 3-splitScreen Switches.  
White: One colored plate for a 2-split screen and two colored plates for a 4-split screen.  
Red, green, or orange: One colored plate for a 2-split screen and one colored plates for a 4-split screen.

Ordering set combinations: Refer to pages 3 to 4.

■ Specifications: Refer to the A3P.

■ Dimensions: Refer to page 11. Accessories: Refer to the A3P.

## Ordering Information

**Ordering Individually** ..... Displays, Lamps, and Sockets can be ordered separately. Combinations that are not available as sets can be created using individual Units. Also, store the parts as spares for maintenance and repairs.

Display

### Incandescent Lamp-lighted Models (Incandescent lamp is not built-in.)

| Model                     | Rectangular models | Square models | Round models | Selection precautions |       |             |
|---------------------------|--------------------|---------------|--------------|-----------------------|-------|-------------|
| Screen pattern            | Screen             | Model         | Model        | Model                 | Model | Model       |
| Single screen             |                    | M2PJ-5011     |              | M2PA-5011             |       | M2PT-5011 * |
| Horizontal 2-split screen |                    | M2PJ-5012     |              | M2PA-5012             | ---   | ---         |
| Vertical 2-split screen   |                    | M2PJ-5013     | ---          | ---                   | ---   | ---         |
| Horizontal 3-split screen |                    | M2PJ-5014     | ---          | ---                   | ---   | ---         |
| Vertical 3-split screen   |                    | M2PJ-5015     | ---          | ---                   | ---   | ---         |
| 4-split screen            |                    | M2PJ-5016     | ---          | ---                   | ---   | ---         |

| Screen pattern            | White | Red | Green | Orange | Blue |
|---------------------------|-------|-----|-------|--------|------|
| Single screen             | 1     | 1   | 1     | 1      | 1    |
| Horizontal 2-split screen | 1     | 1   | 1     | 1      | 1    |
| Vertical 2-split screen   | 1     | 1   | 1     | 1      | 1    |
| Horizontal 3-split screen | 2     | 2   | 2     | 2      | 2    |
| Vertical 3-split screen * | 2     | 2   | 2     | 2      | 2    |
| 4-split screen            | 2     | 2   | 2     | 2      | 2    |

\* The following types of colored plates are included with Horizontal and Vertical 3-split Screen Switches.  
All colors: One colored plate for a 2-split screen and one colored plate for a 4-split screen.

### Chameleon Models (with Built-in LED)

| Shape | Rated voltage | Chameleon indicator |
|-------|---------------|---------------------|
|       | 12 VDC        | M2PJ-5800-12E       |
|       | 24 VDC        | M2PJ-5800-24E       |
|       | 12 VDC        | M2PA-5800-12E       |
|       | 24 VDC        | M2PA-5800-24E       |

Note: 1. With the chameleon models, the whole screen lights red, green, or orange (i.e., red and green simultaneously).  
2. A cap, legend plate (transparent), white colored plate, and LED (with a current-limiting resistor) are built into the Display.

Lamp (For mounting, refer to the A3P.)

### LED Lamp

| Color  | Voltage | 5 VDC           | 12 VDC          | 24 VDC          | Applicable cap (color) (colored plate) | Selection precautions  |
|--------|---------|-----------------|-----------------|-----------------|--|--|
|        |         | Model (DC only) | Model (DC only) | Model (DC only) |  |  |
| Red    |         | SLL-05ER        | SLL-12ER        | SLL-24ER        | Red                                    | In the standard setup, 4 LED lamps are used with M2PJ models and 2 LED lamps are used with M2PA and M2PT models. |
| Yellow |         | SLL-05EY        | SLL-12EY        | SLL-24EY        | Orange                                 |  |
| Green  |         | SLL-05EG        | SLL-12EG        | SLL-24EG        | Green                                  |  |
| White  |         | SLL-05EW        | SLL-12EW        | SLL-24EW        | White                                  |  |

### Incandescent Lamp

| Voltage    | Lamp type | Standard lamp | Low-voltage lamp | Selection precautions   |
|------------|-----------|---------------|------------------|---|
| 5 VAC/VDC  |           | SLL-06        | SLL-06H          | <ul style="list-style-type: none"> <li>In the standard setup for M2PJ models, 2 lamps are used with single screen models, and 4 lamps are used with split-screen models. If 3 or 4 lamps are lit continuously, use low-power lamps.</li> <li>In the standard setup for M2PA models, 1 lamp is used with single screen models, and 2 lamps are used with split-screen models.</li> <li>In the standard setup for M2PT models, 2 lamps are used.</li> </ul> |
| 12 VAC/VDC |           | SLL-14        | SLL-14H          |   |
| 24 VAC/VDC |           | SLL-28        | SLL-28H          |   |

Socket (common to both incandescent lamp-lighted and LED-lighted models)

| Rectangular | Square      | Round       | Selection precautions  |
|-------------|-------------|-------------|--|
| Model       | Model       | Model       |  |
| M2PJ-7010-1 | M2PA-7010-1 | M2PT-7010-2 | <ul style="list-style-type: none"> <li>The end digit denotes the color of the flange: -1 denotes a black flange, and -2 denotes a light gray flange. Round switches are available only in light gray, and not in black.</li> </ul> |

Ordering set combinations: Refer to pages 3 to 4.

■ Specifications: Refer to the A3P.  
■ Dimensions: Refer to page 11. Accessories: Refer to the A3P.



## Ordering Information

### Accessories

Accessories are the same as those for the A3P Lighted Pushbutton Switches. Refer to the A3P.

### LED and Incandescent Lamp Ratings and Characteristics

Ratings and characteristics the same as those for the A3P Lighted Pushbutton Switches. Refer to the A3P.

### Approved Standard Ratings

UL (File No. E41515), CSA (File No. LR45258)

LED: 24 VDC max.

























Incandescent lamp: 28 VAC/VDC, 1.2 W max.

Note: Certification has been obtained for the Indicator.

For detailed information on individual products that have received certification, consult your supplier.

## Nomenclature

### Construction

| Lighting method | LED-lighted models (LED is built-in.)  |  | LED lamp-lighted models (LED is not built-in.)   |  |  |  | Incandescent lamp-lighted models (Incandescent lamp is not built-in.)                                |  |  |  |
|-----------------|--|--|--|--|--|--|--|--|--|--|
|                 | M2PJ   | M2PA   | M2PJ   |  | M2PA   | M2PT   | M2PJ   |  | M2PA   | M2PT   |
| Screen pattern  | Single screen<br>             | Single screen<br>             | Single screen<br>             | Vertical 3-split screen<br>   | Single screen<br>             | Single screen<br> | Single screen<br> | Vertical 3-split screen<br>   | Single screen<br>             | Single screen<br>             |
|                 | Horizontal 2-split screen<br> | Horizontal 2-split screen<br> | Horizontal 2-split screen<br> | Horizontal 3-split screen<br> | Horizontal 2-split screen<br> |  |  | Horizontal 2-split screen<br> | Horizontal 3-split screen<br> | Horizontal 2-split screen<br> |
|                 | Chameleon (3-color)<br>       | Chameleon (3-color)<br>       | Vertical 2-split screen<br>   | 4-split screen<br>            |  |  |  | Vertical 2-split screen<br>   | 4-split screen<br>            |  |
|                 |  |  |  |  |  |  |  |  |  |  |

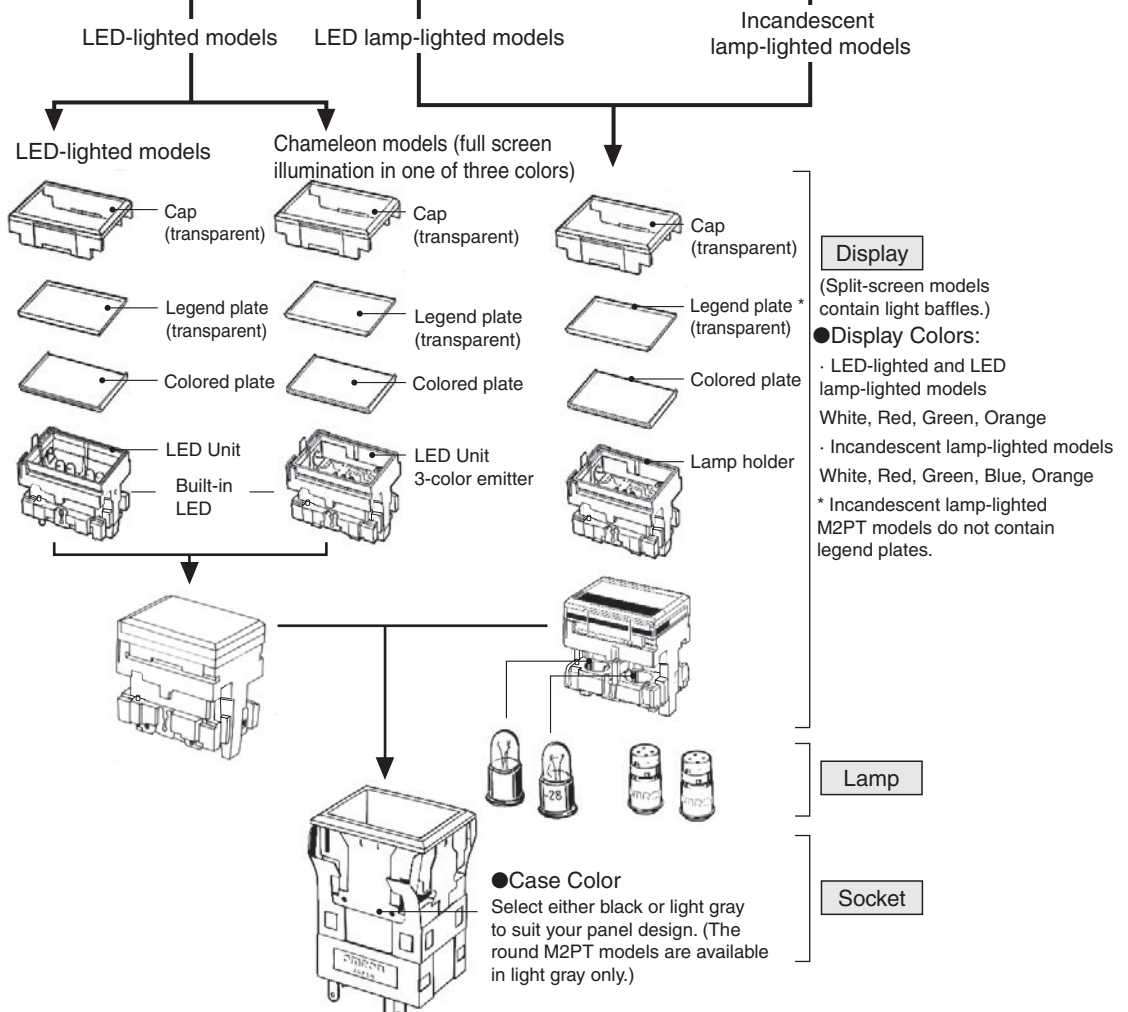

Note: The above diagram for LED lamp-lighted and incandescent lamp-lighted models shows the M2PJ model.

Nomenclature

M2P Lighting Method Diagram

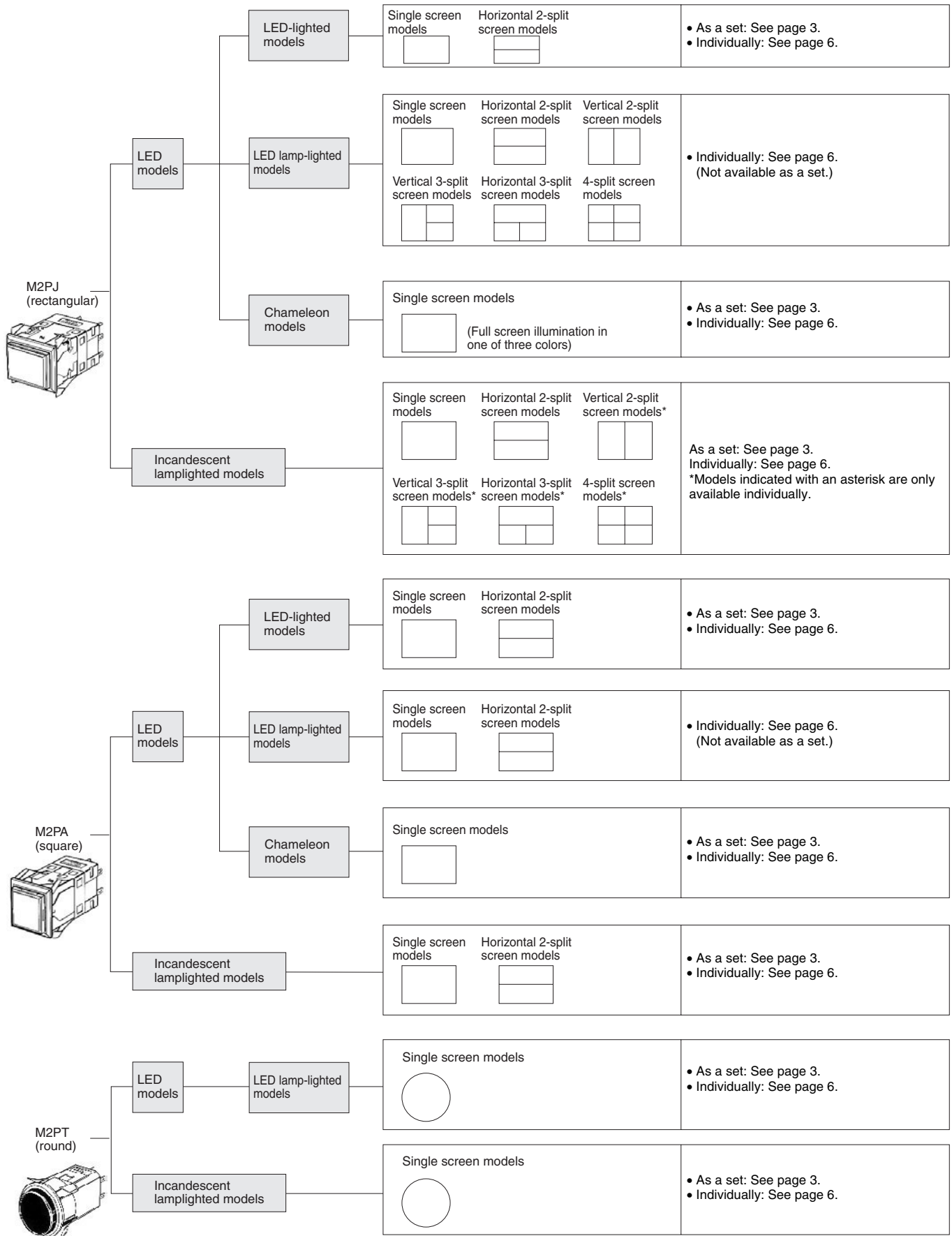

Dimensions

M2PJ (Rectangular) Models

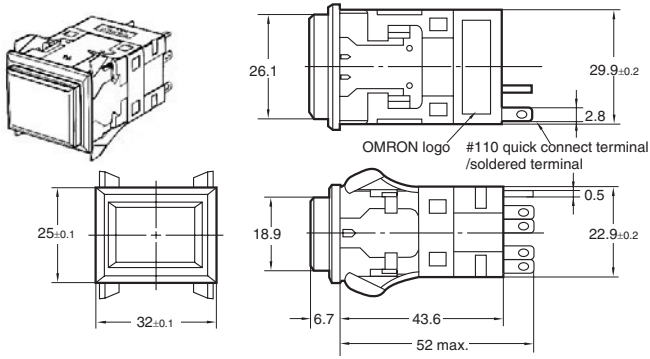

M2PA (Square) Models

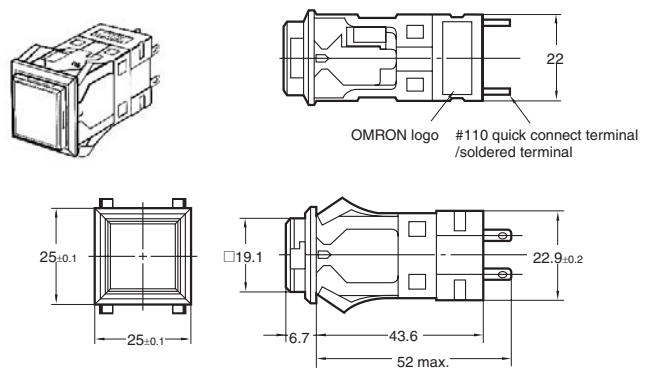

M2PT (Round) Models

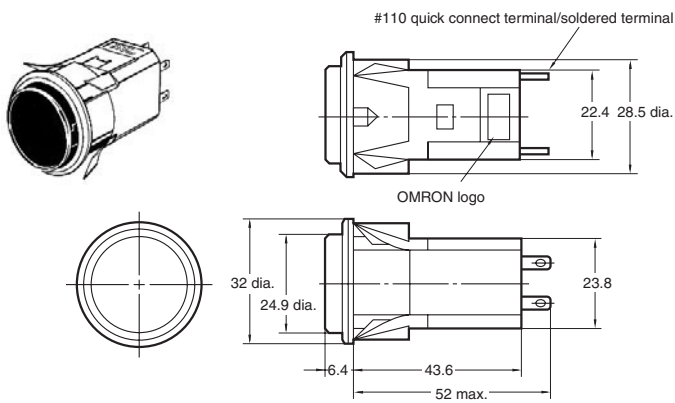

Note: Use a panel thickness of 0.5 mm for tab terminals #110 and solder terminals.

Accessory Mounting Dimensions

Dimensions for mounting accessories are the same as those for the A3P Lighted Pushbutton Switches. Refer to the A3P.

Dimensions

Panel Cutout

M2PJ (Rectangular) Models

| Classification       | Mounting design                  | Panel cutout   | Remarks |   |
|----------------------|----------------------------------|--|---------|---|
| Flange mount models  | Individual mounting (Horizontal) |  |         | Panel cutout spacing between rows of Units:<br>   |
|                      | Multiple mounting (Horizontal)   |  |         |   |
|                      | Individual mounting (Vertical)   | Mount to long mounting plate (A3PJ-3002) before use.<br> |         |   |
|                      | Multiple mounting (Vertical)     | Mount to long mounting plate (A3PJ-3002) before use.<br> |         |   |
| Barrier mount models | Individual mounting (Horizontal) |  |         | For barrier mount models, refer to Accessories on the A3P.<br>Panel cutout spacing between rows of Units:<br>Dotted line indicates the position of each mounting barrier.<br> |
|                      | Multiple mounting (Horizontal)   |  |         |   |
|                      | Individual mounting (Vertical)   | Mount to long mounting plate (A3PJ-3002) before use.<br> |         |   |
|                      | Multiple mounting (Vertical)     | Mount to long mounting plate (A3PJ-3002) before use.<br> |         |   |

- Note: 1. n: Number of Units  
 2. Recommended panel thickness: 1 to 5 mm  
 3. Mount the panel before mounting the Switch Guard.  
 4. If the panel is to be finished (e.g., coated), make sure that the panel meets the specified dimensions after the coating.

M2PA (Square) Models

| Classification       | Mounting design     | Panel cutout | Remarks |   |
|----------------------|---------------------|--------------|---------|---|
| Flange mount models  | Individual mounting |              |         | Panel cutout spacing between rows of Units:<br>   |
|                      | Multiple mounting   |              |         |   |
| Barrier mount models | Individual mounting |              |         | Panel cutout spacing between rows of Units:<br>Dotted line indicates the position of each mounting barrier.<br> |
|                      | Multiple mounting   |              |         |   |

- Note: 1. n: Number of Units  
 2. Recommended panel thickness: 1 to 5 mm  
 3. If the panel is to be finished (e.g., coated), make sure that the panel meets the specified dimensions after the coating.

M2PT (Round) Models

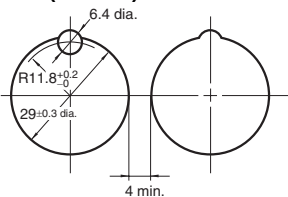





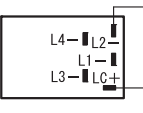
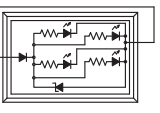
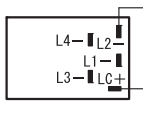
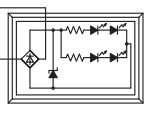
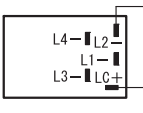
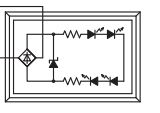

- Note: 1. Recommended panel thickness: 1 to 5 mm  
 2. If the panel is to be finished (e.g., coated), make sure that the panel meets the specified dimensions after the coating

Dimensions

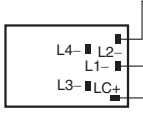
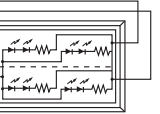
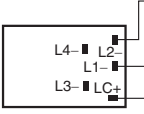
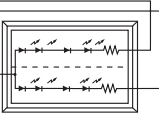
Terminal connections

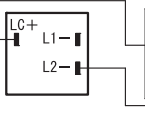
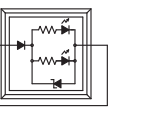
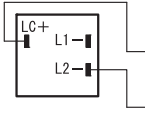
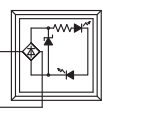
LED-lighted Models

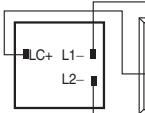
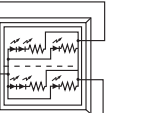
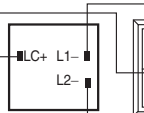
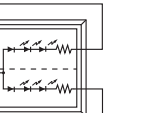
| Rated voltage |   | 5 VDC  |   | 12 VAC/VDC  |  | 24 VAC/VDC   |   |
|---------------|---|--|---|---|--|--|---|
| Model         | Screen pattern  |  |   |   |  |  |   |
| M2PJ          | Single screen<br>    | BOTTOM VIEW<br><br>Terminal arrangement   | TOP VIEW<br><br>Lighting block   | BOTTOM VIEW<br><br>Terminal arrangement    | TOP VIEW<br><br>Lighting block | BOTTOM VIEW<br><br>Terminal arrangement | TOP VIEW<br><br>Lighting block |
|               | 2-split screen<br>   | BOTTOM VIEW<br><br>Terminal arrangement   | TOP VIEW<br><br>Lighting block   | BOTTOM VIEW<br><br>Terminal arrangement   |  | TOP VIEW<br><br>Lighting block          |   |
| M2PA          | Single screen<br>    | BOTTOM VIEW<br><br>Terminal arrangement  | TOP VIEW<br><br>Lighting block  | BOTTOM VIEW<br><br>Terminal arrangement  |  | TOP VIEW<br><br>Lighting block         |   |
|               | 2-split screen<br> | BOTTOM VIEW<br><br>Terminal arrangement | TOP VIEW<br><br>Lighting block | BOTTOM VIEW<br><br>Terminal arrangement |  | TOP VIEW<br><br>Lighting block        |   |

**Incandescent Lamp-lighted/LED Lamp-lighted Models**

(All are shown with the OMRON logo facing down. The terminal arrangements are the same as for the LED-lighted models.)

| Type      | Model | Rectangular M2PJ models  | Square M2PA models   | Round M2PT models  |
|-----------|-------|--|--|--|
| Indicator |       | <p>BOTTOM VIEW      TOP VIEW</p> <p>Terminal arrangement      Lighting block</p> | <p>BOTTOM VIEW      TOP VIEW</p> <p>Terminal arrangement      Lighting block</p> | <p>BOTTOM VIEW      TOP VIEW</p> <p>Terminal arrangement      Lighting block</p> |

**LED Chameleon Models**

| Rated voltage                              | 24 VDC |
|--|--------|
| <p>Model</p> <p>Rectangular M2PJ model</p> |        |
| <p>Square M2PA model</p>                   |        |

**Terminal Arrangement and Coloring  
Chameleon Models**

|          |       |     |                        |
|----------|-------|-----|------------------------|
| Wiring   | LC+   | LC+ | LC+                    |
|          | L1-   | L2- | L1- and L2-<br>shorted |
| Coloring | Green | Red | Orange                 |

**Safety Precautions**

Refer to *Safety Precautions for All Pushbutton Switches/Indicators* and *Safety Precautions for the A3P*.

## Terms and Conditions Agreement

### Read and understand this catalog.

Please read and understand this catalog before purchasing the products. Please consult your OMRON representative if you have any questions or comments.

### Warranties.

(a) Exclusive Warranty. Omron's exclusive warranty is that the Products will be free from defects in materials and workmanship for a period of twelve months from the date of sale by Omron (or such other period expressed in writing by Omron). Omron disclaims all other warranties, express or implied.

(b) Limitations. OMRON MAKES NO WARRANTY OR REPRESENTATION, EXPRESS OR IMPLIED, ABOUT NON-INFRINGEMENT, MERCHANTABILITY OR FITNESS FOR A PARTICULAR PURPOSE OF THE PRODUCTS. BUYER ACKNOWLEDGES THAT IT ALONE HAS DETERMINED THAT THE PRODUCTS WILL SUITABLY MEET THE REQUIREMENTS OF THEIR INTENDED USE.

Omron further disclaims all warranties and responsibility of any type for claims or expenses based on infringement by the Products or otherwise of any intellectual property right. (c) Buyer Remedy. Omron's sole obligation hereunder shall be, at Omron's election, to (i) replace (in the form originally shipped with Buyer responsible for labor charges for removal or replacement thereof) the non-complying Product, (ii) repair the non-complying Product, or (iii) repay or credit Buyer an amount equal to the purchase price of the non-complying Product; provided that in no event shall Omron be responsible for warranty, repair, indemnity or any other claims or expenses regarding the Products unless Omron's analysis confirms that the Products were properly handled, stored, installed and maintained and not subject to contamination, abuse, misuse or inappropriate modification. Return of any Products by Buyer must be approved in writing by Omron before shipment. Omron Companies shall not be liable for the suitability or unsuitability or the results from the use of Products in combination with any electrical or electronic components, circuits, system assemblies or any other materials or substances or environments. Any advice, recommendations or information given orally or in writing, are not to be construed as an amendment or addition to the above warranty.

See <http://www.omron.com/global/> or contact your Omron representative for published information.

### Limitation on Liability: Etc.

OMRON COMPANIES SHALL NOT BE LIABLE FOR SPECIAL, INDIRECT, INCIDENTAL, OR CONSEQUENTIAL DAMAGES, LOSS OF PROFITS OR PRODUCTION OR COMMERCIAL LOSS IN ANY WAY CONNECTED WITH THE PRODUCTS, WHETHER SUCH CLAIM IS BASED IN CONTRACT, WARRANTY, NEGLIGENCE OR STRICT LIABILITY.

Further, in no event shall liability of Omron Companies exceed the individual price of the Product on which liability is asserted.

### Suitability of Use.

Omron Companies shall not be responsible for conformity with any standards, codes or regulations which apply to the combination of the Product in the Buyer's application or use of the Product. At Buyer's request, Omron will provide applicable third party certification documents identifying ratings and limitations of use which apply to the Product. This information by itself is not sufficient for a complete determination of the suitability of the Product in combination with the end product, machine, system, or other application or use. Buyer shall be solely responsible for determining appropriateness of the particular Product with respect to Buyer's application, product or system. Buyer shall take application responsibility in all cases.

NEVER USE THE PRODUCT FOR AN APPLICATION INVOLVING SERIOUS RISK TO LIFE OR PROPERTY OR IN LARGE QUANTITIES WITHOUT ENSURING THAT THE SYSTEM AS A WHOLE HAS BEEN DESIGNED TO ADDRESS THE RISKS, AND THAT THE OMRON PRODUCT(S) IS PROPERLY RATED AND INSTALLED FOR THE INTENDED USE WITHIN THE OVERALL EQUIPMENT OR SYSTEM.

### Programmable Products.

Omron Companies shall not be responsible for the user's programming of a programmable Product, or any consequence thereof.

### Performance Data.

Data presented in Omron Company websites, catalogs and other materials is provided as a guide for the user in determining suitability and does not constitute a warranty. It may represent the result of Omron's test conditions, and the user must correlate it to actual application requirements. Actual performance is subject to the Omron's Warranty and Limitations of Liability.

### Change in Specifications.

Product specifications and accessories may be changed at any time based on improvements and other reasons. It is our practice to change part numbers when published ratings or features are changed, or when significant construction changes are made. However, some specifications of the Product may be changed without any notice. When in doubt, special part numbers may be assigned to fix or establish key specifications for your application. Please consult with your Omron's representative at any time to confirm actual specifications of purchased Product.

### Errors and Omissions.

Information presented by Omron Companies has been checked and is believed to be accurate; however, no responsibility is assumed for clerical, typographical or proofreading errors or omissions.