

PSI-MOS-RS232/FO1300 E - FO converters



2708588

<https://www.phoenixcontact.com/us/products/2708588>

Please be informed that the data shown in this PDF document is generated from our online catalog. Please find the complete data in the user documentation. Our general terms of use for downloads are valid.



Fiber optic converter with integrated optical diagnostics, alarm contact, for RS-232 interfaces up to 115.2 kbps, termination device with one fiber optic interface (SC duplex), 1300 nm, for fiberglass cable

Your advantages

- Connections can be plugged in via a COMBICON screw terminal block
- Supply voltage and data signals routed through the DIN rail connectors
- Redundant power supply possible by means of optional system power supply unit
- High-quality electrical isolation between all interfaces (RS-232 // fiber optic ports // power supply // DIN rail connector)
- Approved for use in zone 2
- Floating switch contact for advance warning of critical FO paths
- Integrated optical diagnostics for continuous monitoring of FO paths
- Automatic data rate detection for all data rates up to 115.2 kbps

Commercial data

Item number	2708588
Packing unit	1 pc
Minimum order quantity	1 pc
Sales key	DN06
Product key	DNC215
Catalog page	Page 439 (C-6-2019)
GTIN	4046356176286
Weight per piece (including packing)	245.8 g
Weight per piece (excluding packing)	183.78 g
Customs tariff number	85176200
Country of origin	DE

Technical data

Notes

Utilization restriction

EMC note	EMC: class A product, see manufacturer's declaration in the download area
----------	---

Utilization restriction

CCCex note	Use in potentially explosive areas is not permitted in China.
------------	---

Product properties

Product type	Media converter
MTTF	942 Years (SN 29500 standard, temperature 25°C, operating cycle 21%)
	418 Years (SN 29500 standard, temperature 40°C, operating cycle 34.25%)
	172 Years (SN 29500 standard, temperature 40°C, operating cycle 100%)
MTBF	549 Years (Telcordia standard, 25°C temperature, 21% operating cycle (5 days a week, 8 hours a day))
	113 Years (Telcordia standard, 40°C temperature, 34.25% operating cycle (5 days a week, 12 hours a day))

Electrical properties

Electrical isolation	VCC // V.24 (RS-232)
Maximum power dissipation for nominal condition	2.5 W
Test voltage data interface/power supply	1.5 kV _{rms} (50 Hz, 1 min.)

Supply

Supply voltage range	18 V DC ... 32 V DC
Nominal supply voltage	24 V DC (in acc. with UL)
Typical current consumption	100 mA (24 V DC)
Max. current consumption	≤ 2 A (For operation in a joining station, via the DIN rail connector)

Output data

Switching

Output name	Relay output
Output description	Alarm output
Number of outputs	1
Maximum switching voltage	60 V DC
	42 V AC
Limiting continuous current	1 A

Connection data

PSI-MOS-RS232/FO1300 E - FO converters



2708588

<https://www.phoenixcontact.com/us/products/2708588>

Supply

Connection method	COMBICON plug-in screw terminal block
Tightening torque	0.56 Nm ... 0.79 Nm

Interfaces

Bit distortion, input	± 35 % (permitted)
Bit distortion, output	< 6.25 %
Signal	Modbus
Transmission channels	2 (1/1), RxD, TxD, full duplex

Data: optical FO

No. of channels	1
Transmit capacity, minimum	-3.4 dBm (50/125 µm, multimode fiberglass)
	-4.7 dBm (62.5/125 µm, multimode fiberglass)
	-5.5 dBm (9/125 µm, singlemode fiberglass)
Transmission length incl. 3 dB system reserve	27 km (With F-G 50/125 0.7 dB/km at 1300 nm)
	22 km (with F-G 62.5/125 0.8 dB/km at 1300 nm)
	45 km (With F-E 9/125 0,4 dB/km at 1300 nm)
Transmission protocol	Transparent to protocol for RS-232 interface
Connection method	SC duplex
Wavelength	1300 nm
Minimum receiver sensitivity	-25.5 dBm (50/125 µm, multimode fiberglass)
	-25.5 dBm (62.5/125 µm, multimode fiberglass)
	-26.5 dBm (9/125 µm, singlemode fiberglass)
Maximum receiver sensitivity	0 dBm
Transmission medium	Multi-mode fiberglass
	Single-mode fiberglass

Data: V.24 (RS-232) interface in acc. with ITU-T V.28, EIA/TIA-232, DIN 66259-1

Serial transmission speed	9.6 Kbps ... 115.2 Kbps
Connection method	D-SUB 9 plug
Transmission length	≤ 15 m
Single conductor/terminal point, rigid	0.2 mm² ... 2.5 mm²
Single-wire/terminal point, flexible	0.2 mm² ... 2.5 mm²
Max. AWG conductor cross section, flexible	14
Min. AWG conductor cross section, flexible	24
Single-wire/terminal point, rigid AWG max.	14
Single-wire/terminal point, rigid AWG min.	24
Transmission medium	Copper
File format/coding	UART (11 Bit, NRZ)
Data direction switching	Automatic control

Dimensions

PSI-MOS-RS232/FO1300 E - FO converters



2708588

<https://www.phoenixcontact.com/us/products/2708588>

Dimensional drawing	
Width	35 mm
Height	99 mm
Depth	105 mm

Material specifications

Color (Housing)	green (RAL 6021)
Material (Housing)	PA 6.6-FR

Cable/line

FO cable

Fiber types	50/125 µm
	9/125 µm
	Fiberglass

Environmental and real-life conditions

Ambient conditions

Degree of protection	IP20
Ambient temperature (operation)	-20 °C ... 60 °C
Ambient temperature (storage/transport)	-40 °C ... 85 °C
Altitude	≤ 5000 m (For restrictions, see the manufacturer's declaration for altitude operation)
Permissible humidity (operation)	30 % ... 95 % (non-condensing)

Approvals

CE

Certificate	CE-compliant
-------------	--------------

ATEX

Identification	⊕ II 3 G Ex nA nC IIC T4 Gc X
Note	Please follow the special installation instructions in the documentation!

UL, USA/Canada

Identification	508 Listed
	508 Recognized

Corrosive gas test

Identification	ISA-S71.04-1985 G3 Harsh Group A
----------------	----------------------------------

EMC data

Noise immunity	EN 61000-6-2:2005
Electromagnetic compatibility	Conformance with EMC Directive 2014/30/EU
Noise emission	EN 55011

Electrostatic discharge

Standards/regulations	EN 61000-4-2
-----------------------	--------------

Electrostatic discharge

Contact discharge	± 6 kV
Discharge in air	± 8 kV
Comments	Criterion B

Electromagnetic HF field

Standards/regulations	EN 61000-4-3
-----------------------	--------------

Electromagnetic HF field

Field intensity	10 V/m
Comments	Criterion A

Fast transients (burst)

Standards/regulations	EN 61000-4-4
-----------------------	--------------

Fast transients (burst)

Input	± 2 kV
Signal	± 2 kV
Comments	Criterion B

Surge current load (surge)

Standards/regulations	EN 61000-4-5
-----------------------	--------------

Surge current load (surge)

Input	± 0.5 kV
Signal	± 1 kV
Comments	Criterion B

Conducted interference

Standards/regulations	EN 61000-4-6
-----------------------	--------------

Conducted interference

Comments	Criterion A
Voltage	10 V

Emitted interference

Standards/regulations	EN 55011
Comments	Class A, industrial applications

Criteria

Criterion A	Normal operating behavior within the specified limits.
-------------	--

PSI-MOS-RS232/FO1300 E - FO converters



2708588

<https://www.phoenixcontact.com/us/products/2708588>

Criterion B	Temporary impairment to operational behavior that is corrected by the device itself.
-------------	--

Standards and regulations

Free from substances that could impair the application of coating	in accordance with VW-AUDI-Seat central standard P-VW 3.10.7 57 65 0
---	--

Mounting

Mounting type	DIN rail mounting
---------------	-------------------

Drawings

Schematic diagram

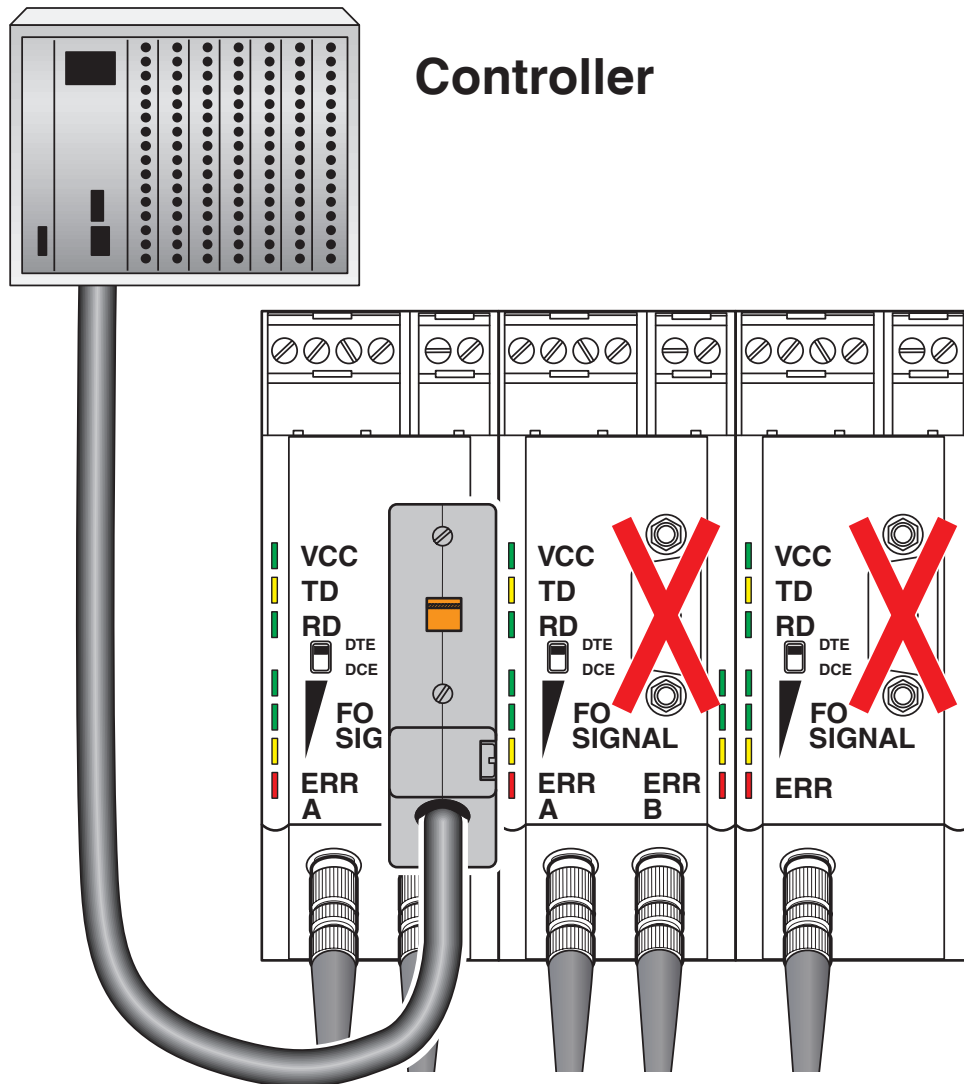

Connecting data cables

2708588

<https://www.phoenixcontact.com/us/products/2708588>

Application drawing

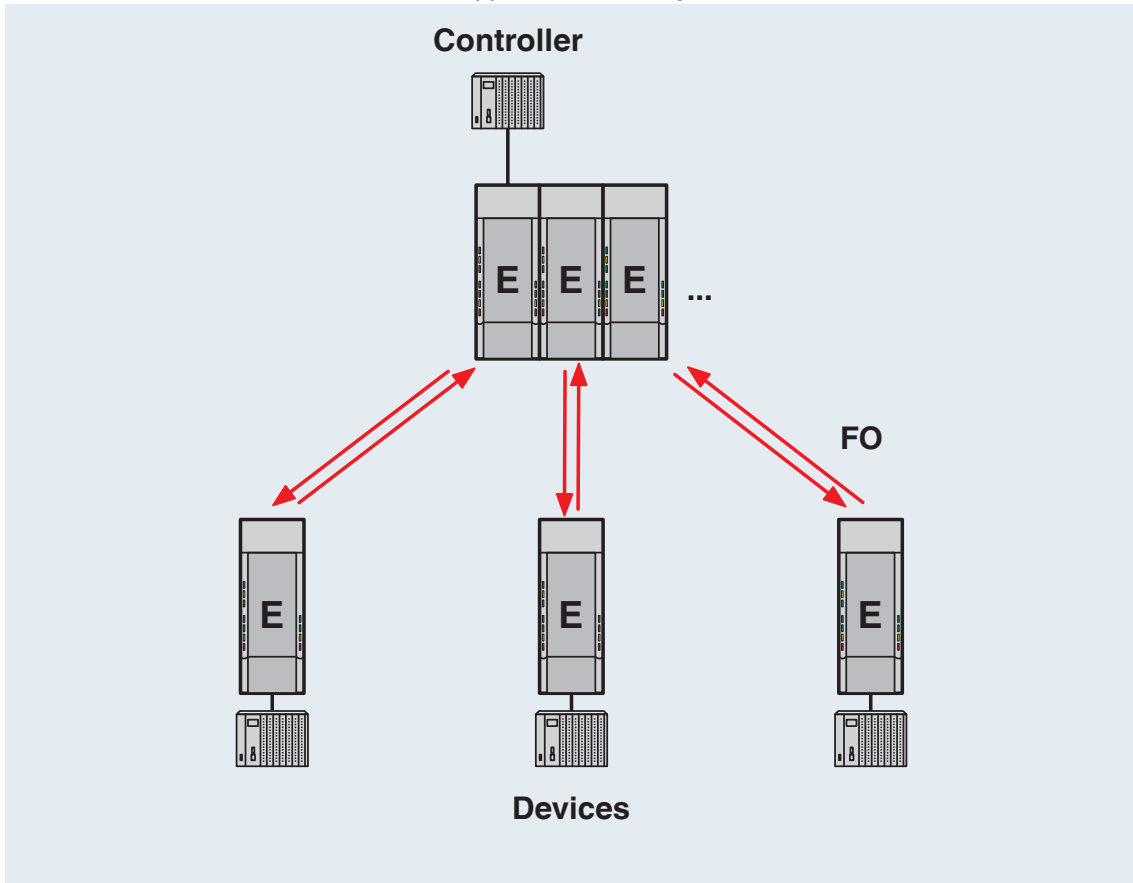

Star structure

2708588

<https://www.phoenixcontact.com/us/products/2708588>

Application drawing

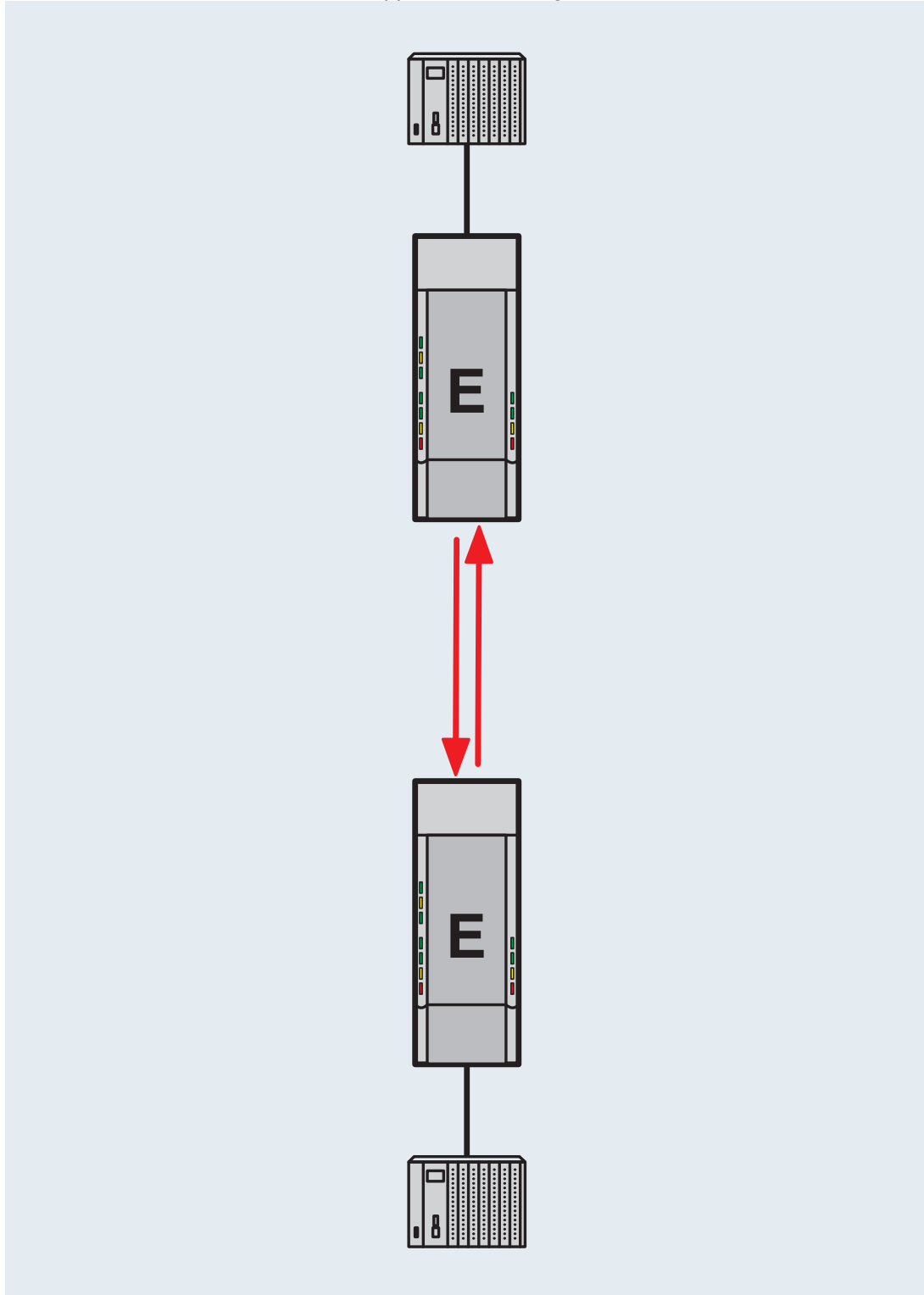

Point-to-point connection

PSI-MOS-RS232/FO1300 E - FO converters



2708588

<https://www.phoenixcontact.com/us/products/2708588>

Block diagram

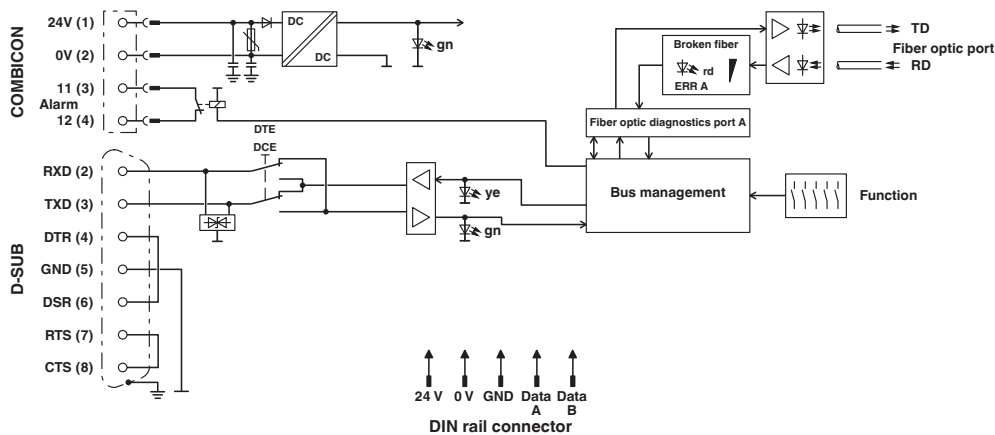

Basic circuit diagram

Dimensional drawing

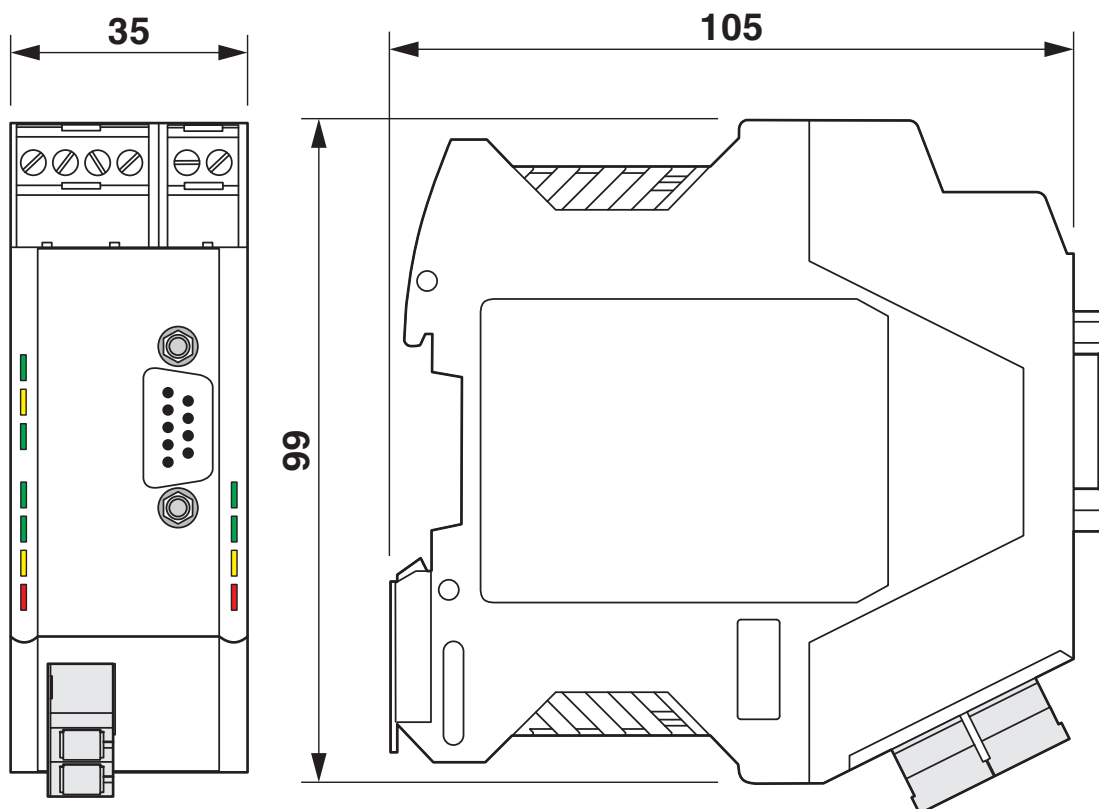

Housing dimensions

PSI-MOS-RS232/FO1300 E - FO converters



2708588

<https://www.phoenixcontact.com/us/products/2708588>

Approvals

To download certificates, visit the product detail page: <https://www.phoenixcontact.com/us/products/2708588>



cUL Recognized
Approval ID: FILE E 238705



UL Recognized
Approval ID: FILE E 238705

UAE-RoHS
Approval ID: 23-02-63194



cULus Listed
Approval ID: E238705



ATEX
Approval ID: PxCIF07ATEX2708559X

cULus Recognized

PSI-MOS-RS232/FO1300 E - FO converters



2708588

<https://www.phoenixcontact.com/us/products/2708588>

Classifications

ECLASS

ECLASS-11.0	19170411
ECLASS-12.0	19170411
ECLASS-13.0	19170411

ETIM

ETIM 9.0	EC001467
----------	----------

UNSPSC

UNSPSC 21.0	43201500
-------------	----------

2708588

<https://www.phoenixcontact.com/us/products/2708588>

Environmental product compliance

EU RoHS

Fulfills EU RoHS substance requirements	Yes
Exemption	6(c), 7(a), 7(c)-I

China RoHS

Environment friendly use period (EFUP)	EFUP-50
	An article-related China RoHS declaration table can be found in the download area for the respective article under "Manufacturer declaration". For all articles with EFUP-E, no China RoHS declaration table issued and required.

EU REACH SVHC

REACH candidate substance (CAS No.)	Lead(CAS: 7439-92-1)
SCIP	79d9c3e3-067f-49ba-ab9e-5448ae9e7261

PSI-MOS-RS232/FO1300 E - FO converters



2708588

<https://www.phoenixcontact.com/us/products/2708588>

Accessories

FOC-LC:PA-SC:PA-OM2:D01/1 - FO patch cable

1115607

<https://www.phoenixcontact.com/us/products/1115607>

Multi-mode OM2 duplex jumper, LC-SC, UPC polishing, length 1 m

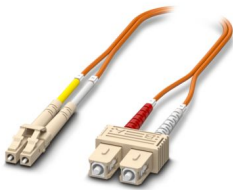

FOC-LC:PA-SC:PA-OM2:D01/2 - FO patch cable

1115605

<https://www.phoenixcontact.com/us/products/1115605>

Multi-mode OM2 duplex jumper, LC-SC, UPC polishing, length 2 m

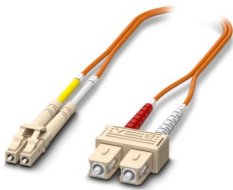

PSI-MOS-RS232/FO1300 E - FO converters

2708588

<https://www.phoenixcontact.com/us/products/2708588>

FOC-SC:PA-SC:PA-OM2:D01/1 - FO patch cable

1115536

<https://www.phoenixcontact.com/us/products/1115536>

Multi-mode OM2 duplex jumper, SC-SC, UPC polishing, length 1 m

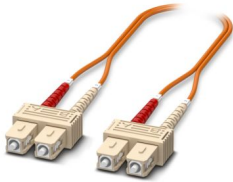

FOC-SC:PA-SC:PA-OM2:D01/2 - FO patch cable

1115535

<https://www.phoenixcontact.com/us/products/1115535>

Multi-mode OM2 duplex jumper, SC-SC, UPC polishing, length 2 m

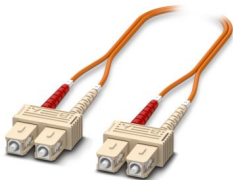

PSI-MOS-RS232/FO1300 E - FO converters



2708588

<https://www.phoenixcontact.com/us/products/2708588>

FOC-ST:PA-SC:PA-OM2:D01/1 - FO patch cable

1115574

<https://www.phoenixcontact.com/us/products/1115574>

Multi-mode OM2 duplex jumper, ST-SC, UPC polishing, length 1 m

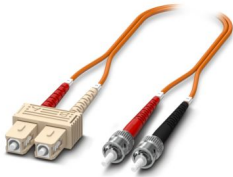

FOC-ST:PA-SC:PA-OM2:D01/2 - FO patch cable

1115573

<https://www.phoenixcontact.com/us/products/1115573>

Multi-mode OM2 duplex jumper, ST-SC, UPC polishing, length 2 m

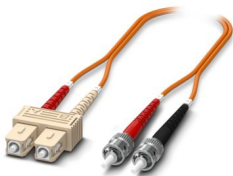

PSI-MOS-RS232/FO1300 E - FO converters

2708588

<https://www.phoenixcontact.com/us/products/2708588>

FOC-LC:PA-SC:PA-OM4:D01/1 - FO patch cable

1115601

<https://www.phoenixcontact.com/us/products/1115601>

Multi-mode OM4 duplex jumper, LC-SC, UPC polishing, length 1 m

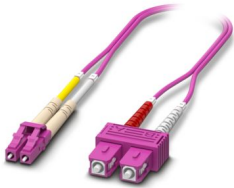

FOC-LC:PA-SC:PA-OM4:D01/2 - FO patch cable

1115600

<https://www.phoenixcontact.com/us/products/1115600>

Multi-mode OM4 duplex jumper, LC-SC, UPC polishing, length 2 m

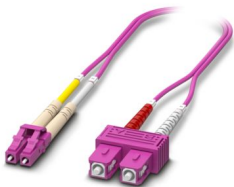

PSI-MOS-RS232/FO1300 E - FO converters



2708588

<https://www.phoenixcontact.com/us/products/2708588>

FOC-SC:PA-SC:PA-OM4:D01/1 - FO patch cable

1115424

<https://www.phoenixcontact.com/us/products/1115424>

Multi-mode OM4 duplex jumper, SC-SC, UPC polishing, length 1 m

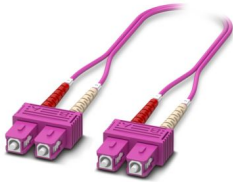

FOC-SC:PA-SC:PA-OM4:D01/2 - FO patch cable

1115423

<https://www.phoenixcontact.com/us/products/1115423>

Multi-mode OM4 duplex jumper, SC-SC, UPC polishing, length 2 m

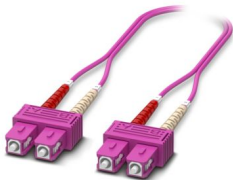

PSI-MOS-RS232/FO1300 E - FO converters

2708588

<https://www.phoenixcontact.com/us/products/2708588>

FOC-SC:PA-SC:PA-OS2:D01/1 - FO patch cable

1115550

<https://www.phoenixcontact.com/us/products/1115550>

Single-mode OS2 duplex jumper, SC-SC, UPC polishing, length 1 m

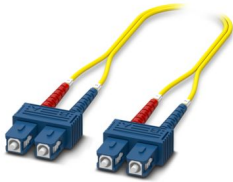

FOC-SC:PA-SC:PA-OS2:D01/2 - FO patch cable

1115548

<https://www.phoenixcontact.com/us/products/1115548>

Single-mode OS2 duplex jumper, SC-SC, UPC polishing, length 2 m

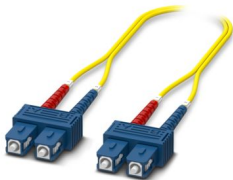

PSI-MOS-RS232/FO1300 E - FO converters

2708588

<https://www.phoenixcontact.com/us/products/2708588>

FOC-ST:PA-SC:PA-OS2:D01/1 - FO patch cable

1115582

<https://www.phoenixcontact.com/us/products/1115582>

Single-mode OS2 duplex jumper, ST-SC, UPC polishing, length 1 m

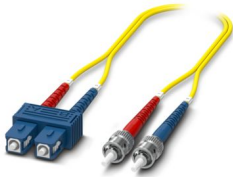

FOC-ST:PA-SC:PA-OS2:D01/2 - FO patch cable

1115581

<https://www.phoenixcontact.com/us/products/1115581>

Single-mode OS2 duplex jumper, ST-SC, UPC polishing, length 2 m

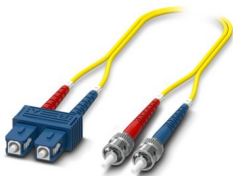

PSI-MOS-RS232/FO1300 E - FO converters

2708588

<https://www.phoenixcontact.com/us/products/2708588>

FOC-LC:PA-SC:PA-OS2:D01/1 - FO patch cable

1115618

<https://www.phoenixcontact.com/us/products/1115618>

Single-mode OS2 duplex jumper, LC-SC, UPC polishing, length 1 m

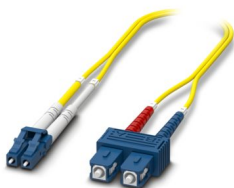

FOC-LC:PA-SC:PA-OS2:D01/2 - FO patch cable

1115617

<https://www.phoenixcontact.com/us/products/1115617>

Single-mode OS2 duplex jumper, LC-SC, UPC polishing, length 2 m

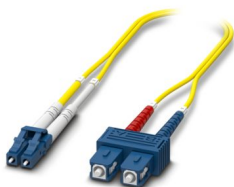

PSI-MOS-RS232/FO1300 E - FO converters



2708588

<https://www.phoenixcontact.com/us/products/2708588>

FOC-GDM-RUGGED-1016/IP20/... - FO patch cable

2901558

<https://www.phoenixcontact.com/us/products/2901558>

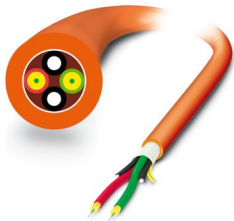

Robust GOF installation cable for assembly (IP20 heads only) for installation in stationary systems and machines, aramid strain-relief elements, with individual elements made from FRNC material, halogen-free, ozone and UV resistant, with a polyurethane (PUR) outer sheath

FOC-GDO-1017/IP20/... - FO patch cable

2901559

<https://www.phoenixcontact.com/us/products/2901559>



Highly rugged GOF round cable (IP20 heads only) for assembly and for outdoor installation with integrated moisture barrier as well as rodent-proof scrim. Individual elements made from highly flexible FRNC material. The wire is ozone and UV resistant with a very rugged polyethylene outer sheath.

PSI-MOS-RS232/FO1300 E - FO converters



2708588

<https://www.phoenixcontact.com/us/products/2708588>

PSM-LWL-GDO- 50/125 - FO cable

2799432

<https://www.phoenixcontact.com/us/products/2799432>



Fiberglass cable, duplex 50/125 μm , by the meter, without connector, for outdoor installation

PSM-LWL-GDM-RUGGED- 50/125 - FO cable

2799322

<https://www.phoenixcontact.com/us/products/2799322>



Fiber glass cable, duplex 50 μm /125 μm , by the meter, without male connector, for installation in stationary systems and machines

PSI-MOS-RS232/FO1300 E - FO converters



2708588

<https://www.phoenixcontact.com/us/products/2708588>

QUINT4-SYS-PS/1AC/24DC/2.5/SC - Power supply unit

2904614

<https://www.phoenixcontact.com/us/products/2904614>



Primary-switched power supply, QUINT POWER, screw connection, DIN rail mounting, supply of devices possible via the TBUS DIN rail connector, protective coating, input: single-phase, output: 24 V DC/2.5 A

ME 17,5 TBUS 1,5/ 5-ST-3,81 GN - DIN rail bus connectors

2709561

<https://www.phoenixcontact.com/us/products/2709561>

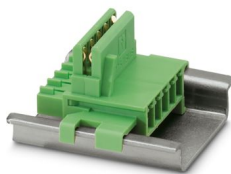

DIN rail connector for DIN rail mounting. Universal for TBUS housing. Gold-plated contacts, 5-pos.

PSI-MOS-RS232/FO1300 E - FO converters



2708588

<https://www.phoenixcontact.com/us/products/2708588>

ME 17,5 TBUS 1,5/PP000-3,81 BK - DIN rail bus connectors

2890014

<https://www.phoenixcontact.com/us/products/2890014>

DIN rail connector for DIN rail mounting. Universal for TBUS housing. Gold-plated contacts, 2-pos.

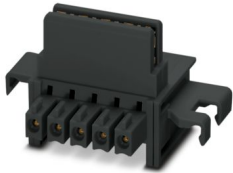

ME 17,5 TBUS 1,5/ 5-ST-3,81 KMGY - DIN rail bus connectors

2713645

<https://www.phoenixcontact.com/us/products/2713645>

DIN rail connector, color: light grey, nominal current: 8 A (parallel contacts), rated voltage (III/2): 125 V, number of positions: 5, product range: TBUS5-17,5..., pitch: 3.81 mm, mounting: DIN rail mounting, locking: without, mounting: without, type of packaging: packed in cardboard, Item with gold-plated contacts, bus connectors for connecting with electronics housings, 5 parallel contacts

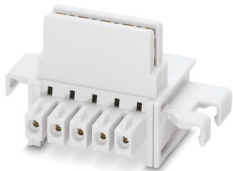

PSI-MOS-RS232/FO1300 E - FO converters

2708588

<https://www.phoenixcontact.com/us/products/2708588>



SUBCON 9/F-SH - D-SUB bus connector

2761499

<https://www.phoenixcontact.com/us/products/2761499>



D-SUB connector, 9-pos. socket, one 35° cable outlet, universal type for all systems, pin assignment: 1, 2, 3, 4, 5, 6, 7, 8, 9 to screw connection terminal block

Phoenix Contact 2024 © - all rights reserved

<https://www.phoenixcontact.com>

Phoenix Contact USA
586 Fulling Mill Road
Middletown, PA 17057, United States
(+717) 944-1300
info@phoenixcon.com