

2205077-3 ✓ ACTIVE

Micro-MaTch | Micro-MaTch Industrial

TE Internal #: 2205077-3

MICRO-MATCH MOW to MICRO-MATCH Cable Assembly, 20 Positions, .2 m [.656 ft], Gray Cable, 28 AWG, 159.8 – 159.88 mm², Ribbon Cable

[View on TE.com >](#)



Cable Assemblies > Copper Cable Assemblies > Pluggable I/O Cable Assemblies > MICRO-MATCH STD PB TO MOW CABLE ASSY

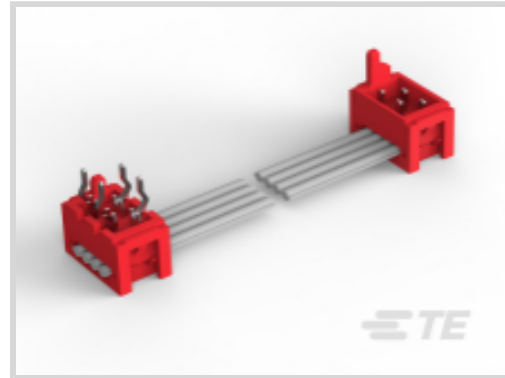

Cable Assembly Type: MICRO-MATCH MOW to MICRO-MATCH

Cable Assembly (End A): MICRO-MATCH MOW Plug

Cable Assembly (End B): MICRO-MATCH Plug

Wire Size: 159.8 – 159.88 mm²

[All MICRO-MATCH STD PB TO MOW CABLE ASSY \(25\)](#)

Features

Product Type Features

Cable Assembly Category	Industry Standard
Cable Assembly Type	MICRO-MATCH MOW to MICRO-MATCH
Cable Assembly (End A)	MICRO-MATCH MOW Plug
Cable Assembly (End B)	MICRO-MATCH Plug
Cable Style	Ribbon Cable

Configuration Features

Keyed Position	1
Number of Positions	20
Number of Signal Positions	20

Body Features

Cable Color	Gray
Cable Flammability Rating	UL 2651
Equalized	No

Mechanical Attachment

Mating Alignment	With
------------------	------

Dimensions

--	--



Wire Size	159.8 – 159.88 mm ²
-----------	--------------------------------

Operation/Application

Shielded	No
----------	----

Halogen Free	No
--------------	----

Other

Cable Assembly Configuration	Double Ended
------------------------------	--------------

Cable Assembly Length	.2 m [.656 ft]
-----------------------	----------------

Product Compliance

[For compliance documentation, visit the product page on TE.com>](#)

EU RoHS Directive 2011/65/EU	Compliant
------------------------------	-----------

EU ELV Directive 2000/53/EC	Compliant
-----------------------------	-----------

China RoHS 2 Directive MIIT Order No 32, 2016	No Restricted Materials Above Threshold
---	---

EU REACH Regulation (EC) No. 1907/2006	Current ECHA Candidate List: JUNE 2024 (241) Candidate List Declared Against: JUNE 2024 (241) Does not contain REACH SVHC
--	---

Halogen Content	Not Low Halogen - contains Br or Cl > 900 ppm.
-----------------	--

Solder Process Capability	Not reviewed for solder process capability
---------------------------	--

Product Compliance Disclaimer

This information is provided based on reasonable inquiry of our suppliers and represents our current actual knowledge based on the information they provided. This information is subject to change. The part numbers that TE has identified as EU RoHS compliant have a maximum concentration of 0.1% by weight in homogenous materials for lead, hexavalent chromium, mercury, PBB, PBDE, DBP, BBP, DEHP, DIBP, and 0.01% for cadmium, or qualify for an exemption to these limits as defined in the Annexes of Directive 2011/65/EU (RoHS2). Finished electrical and electronic equipment products will be CE marked as required by Directive 2011/65/EU. Components may not be CE marked. Additionally, the part numbers that TE has identified as EU ELV compliant have a maximum concentration of 0.1% by weight in homogenous materials for lead, hexavalent chromium, and mercury, and 0.01% for cadmium, or qualify for an exemption to these limits as defined in the Annexes of Directive 2000/53/EC (ELV). Regarding the REACH Regulations, TE's information on SVHC in articles for this part number is still based on the European Chemical Agency (ECHA) 'Guidance on requirements for substances in articles' (Version: 2, April 2011), applying the 0.1% weight on weight concentration threshold at the finished product level. TE is aware of the European Court of Justice ruling of September 10th, 2015 also known as O5A (Once An Article Always An Article) stating that, in case of 'complex object', the threshold for a SVHC must be applied to both the product as a whole and simultaneously to each of the articles forming part of its composition. TE has evaluated this ruling based on the new ECHA "Guidance on requirements for substances in articles" (June 2017, version 4.0) and will be updating its statements accordingly.

Compatible Parts

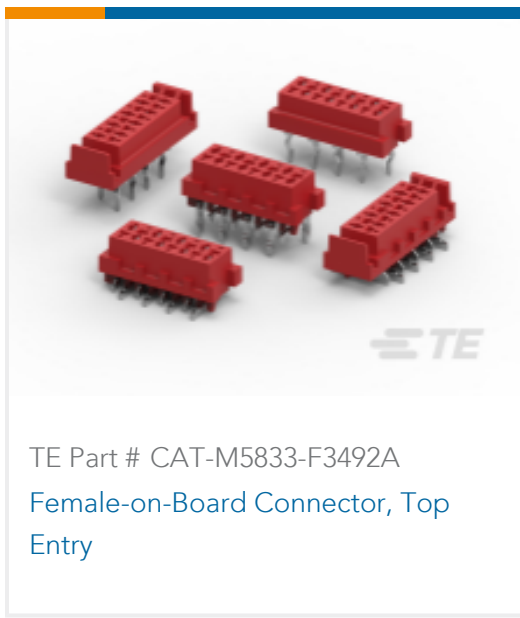

Also in the Series | Micro-MaTch Industrial

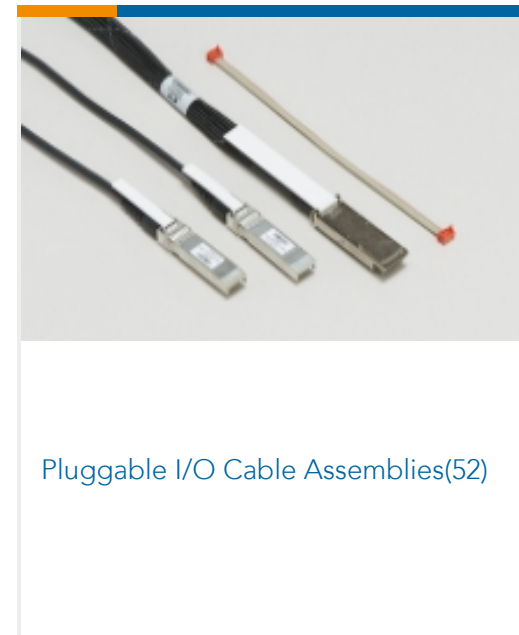
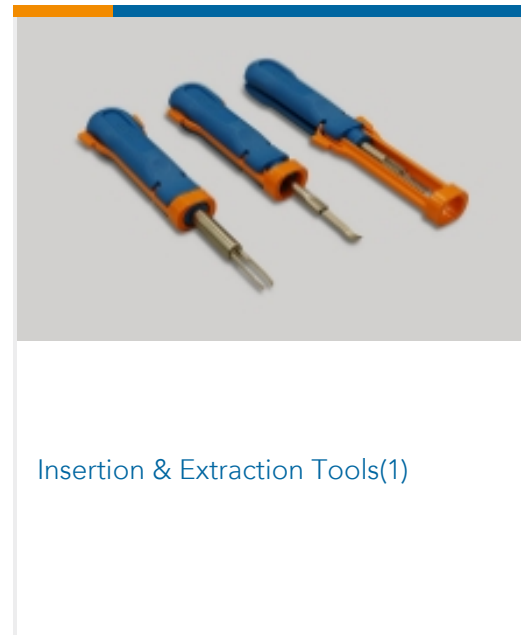
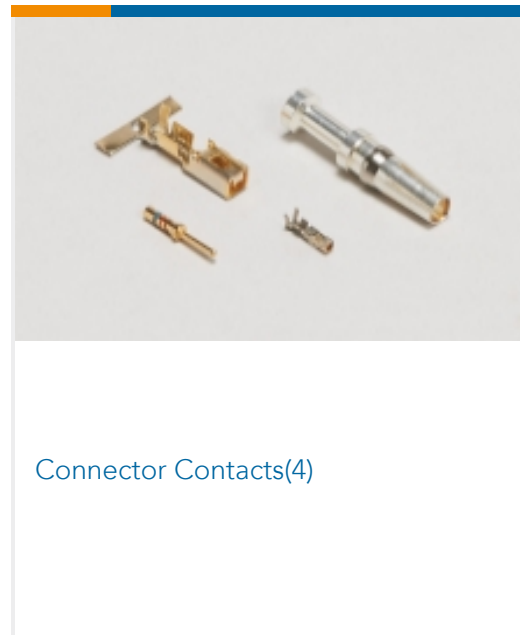
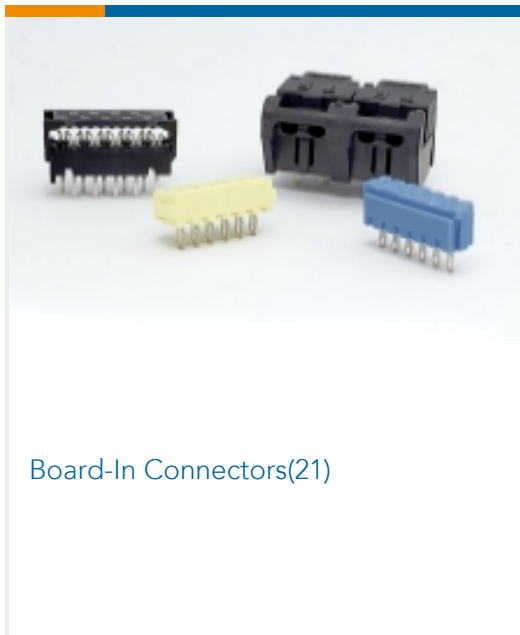

Customers Also Bought

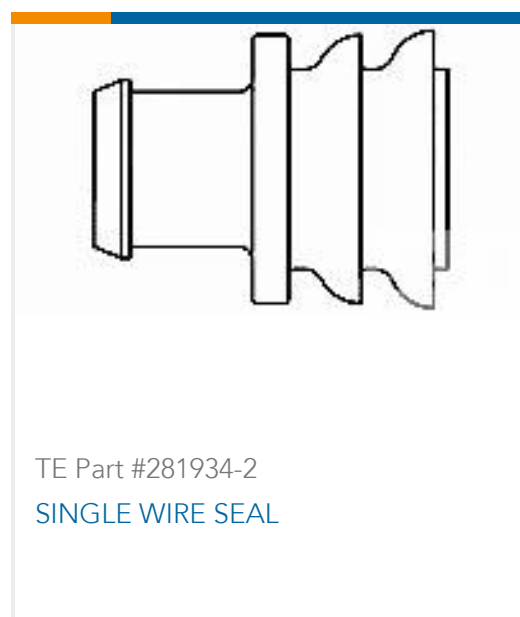



Documents

Product Drawings

[CA MICRO-MATCH MOW-PB 20POS](#)

English

Product Specifications

[Application Specification](#)

English

[micro match miniature connector system](#)

English