



Commercial Networking: Optical Fiber

16

Table of Contents

Commercial Networking — Optical Fiber		Page No.
Introduction		16.2
Optical Fiber Connectivity Products		16.4–16.17
FiberExpress Connectors		16.4
Pre-Connectorized Assemblies		16.6
FiberExpress Secure/Keyed LC System		16.9
FiberExpress Manager		16.11
FiberExpress Patch Panels		16.12
FiberExpress Patch Panels Accessories		16.14
FiberExpress Outlets		16.15
Network Connectivity Products		16.17
Optical Fiber Cables		16.18–16.34
Fiber Cable Selection Guide		16.18
Interconnect Cable — Simplex & Duplex		16.19
Distribution Cable		16.20
Breakout Style Cable		16.22
Industrial Armored Cable		16.24
Tactical Cable		16.25
Ribbon Cable		16.26
Single Jacket, All Dielectric Cable		16.27
Double Jacket, Armored Cable		16.29
Double Jacket, Heavy-Duty Cable		16.30
Central Tube Cable		16.31
Micro Loose Tube Breakout Style Cable		16.33
TrayOptic® Heavy-Duty, All Dielectric Cable		16.34

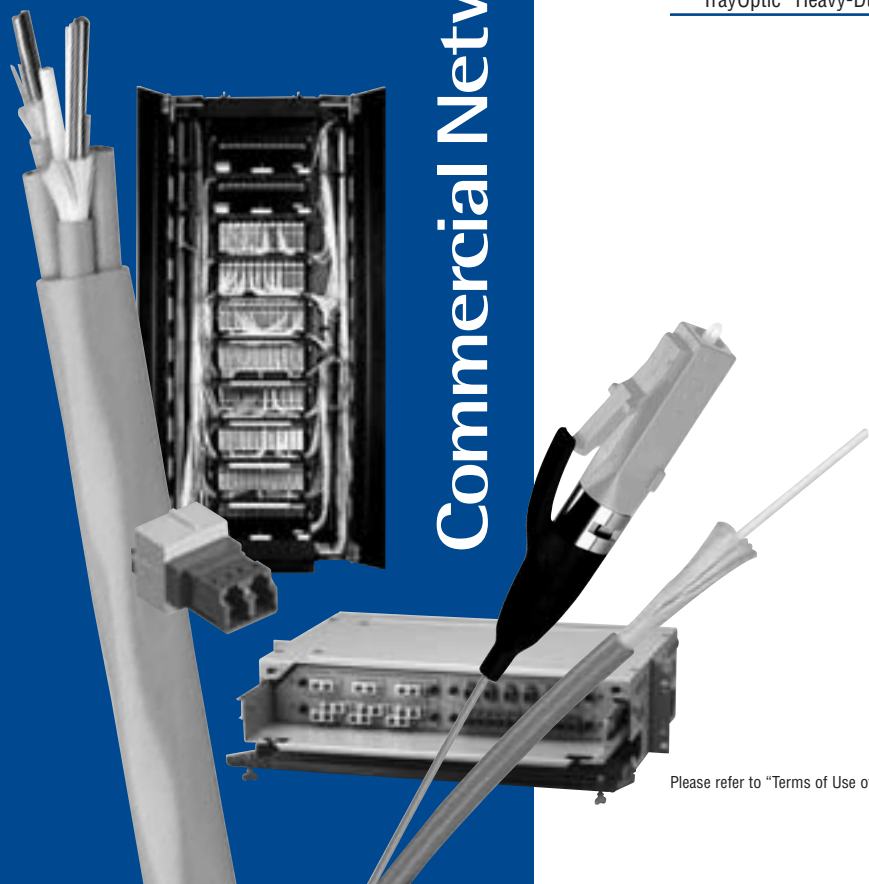

Introduction

Belden IBDN FiberExpress Systems

Optical fiber systems offer many benefits: high bandwidth and transmission speed, the potential for network growth, extended reach, fault tolerance, greater data security and support for Gigabit and multi-Gigabit protocols and networked applications. Beyond these traditional benefits, however, Belden offers the *FiberExpress* Solution, a complete end-to-end cabling system supporting both centralized and fiber-to-the-desk topologies, as well as backbone and campus cabling configurations. Our *FiberExpress* Solutions meet or exceed all applicable TIA/EIA, ISO/IEC and IEEE standards and offer:

- Reduced design complexities
- Greater deployment facility
- Quick installation
- Increased flexibility
- Cost effective pricing

Primary *FiberExpress* System Components

Key components of the *FiberExpress* Systems are summarized below and are found on the catalog pages that follow.

Optimax® Connectors

Optimax Connectors are a revolutionary field-installable optical fiber connector. The unique design of the patented mechanical splice body of Optimax incorporates a factory mounted fiber stub and a pre-polished ceramic ferrule. This technology consistently provides a fast, secure and reliable LC, SC or ST Compatible optical fiber termination for multimode or single-mode cable. All critical steps are performed in the factory, ensuring a superior quality connection every time.



The *FiberExpress* Manager

The *FiberExpress* Manager makes fiber management easier than ever before. Designed to streamline termination, connection and maintenance activities, the *FiberExpress* Manager uses a scalable, modular approach to adapt to a wide variety of situations. The total system provides extra high connection density while facilitating cable routing and patch cord management. The *FiberExpress* Manager is adaptable for almost all situations, traditional field termination or pre-terminated modules, which reduces design complexity and increases deployment efficiency.



Extended Reach Optical Fiber Cables

Extended Reach Optical Fiber Cables propel your network into the future of cable technology with our multimode *FiberExpress* FX300, FX600 or FX2000 series. These series were developed to meet the existing needs of networks at 1 Gb/s (Ethernet, 1000Base-SX and 1000Base-LX) and new networks at 10 Gb/s (Ethernet, 10GBase-S and 10GBase-LX4). These series offer better reach for laser-based systems. For 1 Gb/s Ethernet at 850 nm (VCSEL), the FX300 and FX600 series provide a range of 984 ft (300 m) and 1,968 ft (600 m), respectively. For 10 Gb/s Ethernet at 850 nm (VCSEL), the FX2000 series provide a range of 984 ft (300 m) for 10GBase-S where all of multimode series can offer a 984 ft (300 m) range at 1300 nm (laser) for 10GBase-LX4. All of this while assuring total compatibility with LED systems and FDDI fiber installation cables. Our single-mode cable offering enhances the options for longer distance support — up to 40 km — for any of the Gigabit Ethernet applications.



The *FiberExpress* Bar

The *FiberExpress* Bar is an extremely compact, modular and resilient linking panel. Resembling a power bar, it offers 6 or 12 fibers, pre-terminated with an SC, SC duplex, ST-compatible, LC, MT-RJ or FC connectors



and a cord terminated with a multi-fiber MPO connector — all of which are factory verified. The *FiberExpress* Bar can adapt to all kinds of properties or developments, and can serve as a consolidation or linking point. It's available in both single-mode and multimode media.

For the ultimate in quick, easy and reliable optical networking we also offer the *FiberExpress* Pre-connectorized System. Based on the concept of building blocks, the complete range of pre-terminated *FiberExpress* components bring flexibility to the design stage. The in-factory fabrication and verification of pre-terminated connections ensures the high-performance and high-quality of the product. These products are "plug and go" and their deployment requires no specialized tools — you can deploy 12 fibers in the same amount of time it takes to connect a power cord to a standard electrical plug. This pre-terminated technology will help to preserve the initial investment by its ability to be re-deployed while always ensuring quality results.

Quality Installation and Service

All Belden IBDN systems are designed, installed and field-tested by fully-trained and certified system contractors and integrators to further assure superior systems performance. They are also backed by a strict System Certification and Warranty Program.

System Certification and Warranty Program

The Belden IBDN Certification Program is a rigorous process that ensures that your Belden IBDN 'Certified' System is composed of Belden IBDN components, designed and installed by a factory-trained Certified System Vendor. Belden IBDN 'Certified' Systems are supported by a series of warranties that surpass conventional product warranties. Certification adds important end-to-end system performance guarantees and ensures full compliance with cabling industry standard specifications — even after system installation (Installable Performance®). A 25-year Product Warranty and a Lifetime Application Assurance program accompany each Belden IBDN 'Certified' System installation. These warranty programs include coverage for both parts and labor.

Fiber Channel Topology

FiberExpress® System Matrix	Page No.	Fiber-to-the-Desk (FTTD) and Centralized Fiber	Fiber Backbone (In-Building)	Fiber Backbone (Campus)	FiberExpress Pre-Terminated Solutions*
FiberExpress Cables					
Distribution & Breakout Cable Series Multimode and Single-mode	16.20– 16.23	●			●
Interconnect Cable Series Multimode and Single-mode	16.19	●			
Loose Tube (Campus) Cable Series MM, SM, Composite MM/SM	16.27– 16.34			●	●
Ribbon Cable Series Multimode and Single-mode	16.26	●	●	●	●
Cross-Connect Hardware in the Telecom Room					
FiberExpress Manager with FiberExpress Manager Connector Modules Multimode and Single-mode	16.11	●	●	●	●
FiberExpress Rack Mount Patch Panel with Universal Adapter Strips Multimode and Single-mode	16.12	●		●	●
FiberExpress Wall Mount Patch Panel with Universal Adapter Strips Multimode and Single-mode	16.13	●		●	●
FiberExpress Bar: Multimode and Single-mode	16.8	●	●	●	●
Patch Cords in the Telecom Room and at the Work Area					
FiberExpress Patch Cords: Multimode and Single-mode	16.6	●	●	●	●
Outlets at the Work Area					
MDVO® Multimedia Outlets with MDVO Multimedia Modules	16.16	●			
MediaFlex® Outlets with MediaFlex Multimedia Inserts	16.15	●			
FiberExpress Bar Multimode and Single-mode (as MUTOA)	16.8	●	●		
Fiber Connectivity					
Optimax® Connectors Multimode and Single-mode	16.4	●		●	●
Epoxy Field Mountable Connectors Multimode and Single-mode	16.5	●		●	●
Fiber Pigtailed Multimode and Single-mode	16.8	●		●	●

MM = Multimode • SM = Single-mode

*FiberExpress Pre-terminated Solutions provide simple-to-install, high-performance fiber channels through custom length, high precision factory terminated cables and matching optical connectivity components.

FiberExpress Connectors

Optimax® Field Installable Connectors and Installation Tool Kits

AX101982 Optimax LC Connector



AX100029 with AX101794 Optimax SC Connector



A0408835 with AX101793 Optimax ST Compatible Connector



AX100947 Optimax Tool Kit



Optimax Field Installable Connector

The **Optimax Connectors** are reliable field installable optical fiber connectors that are easy to install. They do not require epoxy, curing or polishing. Their unique design incorporates a factory polished fiber stub in a splice mechanism which provides a fast, secure, and reliable termination on optical fiber cables. All critical steps are performed in the factory, ensuring a superior-quality connection every time. Only simple tools are required for installation, making Optimax a cost effective field termination.

Optimax Connectors are high-quality LC, SC and ST Compatible connectors that use a ceramic ferrule with a physical contact (PC) polish for Multimode and super physical contact (SPC) polish for Single-mode that ensures the best possible mating of optical fibers. Connectors are available for 62.5 or 50/125 μm Multimode fiber and Single-mode fiber installations.

Optimax Installation Tool Kit

The **Optimax Installation Tool Kit** is packaged in a small convenient carrying case and includes an Optimax LC, SC and ST Compatible installation and training video, installation instructions and all the tools required to terminate 900 μm buffered optical fiber and jacketed optical fiber.

The Optimax Installation Tool Kit has all the tools and supplies required to install both the Optimax LC, SC or ST Compatible Multimode and Single-mode connectors. Certain tool kit items can be purchased separately to accommodate installers already possessing basic optical fiber installation tools.

Description	Belden Part Number
-------------	--------------------

FiberExpress Connectors

Optimax Field Installable Connector	
LC 62.5 μm , Multimode*	AX101981
LC 50 μm , Multimode*	AX101982
LC Single-mode*	AX101983
SC 62.5 μm , Multimode*	AX100029
SC 50 μm , Multimode*	AX101077
SC Single-mode*	AX101792
ST Compatible 62.5 μm , Multimode*	A0408835
ST Compatible 50 μm , Multimode*	AX101075
ST Compatible Single-mode*	AX101791
LC Accessory Kit for jacketed fiber (2 mm boot and a crimp sleeve)	AX101984
SC Accessory Kit for jacketed fiber (3 mm boot, crimp sleeves, cord adapter)	AX101794
ST Accessory Kit for jacketed fiber (3 mm boot, crimp sleeves)	AX101793

Optimax Installation Tool Kit	
LC/SC/ST Compatible (includes installation tools, fiber cleaver, crimping tool, instruction manual, microscope, tweezers, alcohol wipes, marker, scissors, waste bottle, fiber stripper, cable stripper and Training Video)	AX100947
Basic (excludes fiber stripper & cleaver)	AX100949
Optimax LC Tool Kit Upgrade (includes LC installation tool, instructions manual, foam for the case)	AX102061

Optimax Individual Components	
Fiber Cleaver	A0408829
Installation Tool LC (does not include tool-clamp)	AX102062
Installation Tools ST Compatible and SC (includes tool-clamp)	A0403634
Microscope	AX100910
Refurbishing Materials (80 alcohol wipes and a black felt tip marker)	AX100951
Installation Instruction Manual, LC	AX102063
Installation Instruction Manual, SC	PX101318
Installation Instruction Manual, ST Compatible	PX101317
Installation & Training Video, CD (see literature ordering form on the web)	NOT0651
Crimp Tool complete with die	A0403641

These products are in the process of being assessed for RoHS compliance. Please check our Web Site for the most current RoHS status.

*For 900 μm buffered fiber only. For Optimax Single-mode termination on jacketed fiber, please use the appropriate Accessory Kit.

FiberExpress Connectors

Epoxy Field Installable Connectors

A0390851 Optical Fiber Field Installable Epoxy Connector, ST Compatible



Epoxy Field Installable Connector

Epoxy Field Installable Connectors are available as Multimode and Single-mode ST Compatible and SC field installable connectors. They require heat-cured epoxy and polishing.

Both types have a ceramic ferrule. Each connector comes complete with all the parts necessary for termination of tight buffered fibers as well as jacketed fibers. Parts include crimp sleeves, boots, cord adapter and dust cap.

Description	Belden Part Number	
	Multimode	Single-mode

FiberExpress Connectors

Epoxy Field Installable Connector		
ST Compatible	A0390851	AX101412
SC Simplex	AX100919	AX101411
SC Duplex	AX100929	

These products are in the process of being assessed for RoHS compliance. Please check our Web Site for the most current RoHS status.

Pre-Connectorized Assemblies

FiberExpress Patch Cords

AX200057 Patch Cord Multimode SC Duplex (568SC)



FiberExpress Patch Cords

FiberExpress Duplex Patch Cord Assemblies are of the highest quality available. They are assembled and 100% optically tested in our factory prior to shipment. All patch cords are built with high-quality connectors and cables which guarantees superior performance and excellent reliability.

Description	Belden Part Number			
	Multimode, FX300, 62.5 μm	Multimode, FX600, 50 μm	Multimode, FX2000, 50 μm	Single-mode SPC

FiberExpress Pre-Connectorized Assemblies

Duplex Patch Cord				
ST-ST, 2 m (6 ft.)	70102419	AX200341	AX200799	AX200090
ST-ST, 3 m (10 ft.)	70102420	AX200459	AX200795	AX200091
ST-ST, 5 m (16 ft.)	70102447	AX200413	AX200800	AX200092
568SC-568SC, 2 m (6 ft.)	AX200056	AX200084	AX200603	AX200094
568SC-568SC, 3 m (10 ft.)	AX200057	AX200082	AX200589	AX200095
568SC-568SC, 5 m (16 ft.)	AX200058	AX200280	AX200624	AX200096
LC duplex-LC duplex, 2 m (6 ft.)	AX200517	AX200527	AX200664	AX200507
LC duplex-LC duplex, 3 m (10 ft.)	AX200518	AX200528	AX200665	AX200508
LC duplex-LC duplex, 5 m (16 ft.)	AX200519	AX200529	AX200666	AX200509
MTRJ-MTRJ, 2 m (6 ft.)	AX101122	AX101139	AX200801	AX101157
MTRJ-MTRJ, 3 m (10 ft.)	AX101123	AX101138	AX200802	AX101156
MTRJ-MTRJ, 5 m (16 ft.)	AX101125	AX101137	AX200803	AX101155
Hybrid Patch Cord				
568SC-ST, 3 m (10 ft.)	AX200060	AX200196	AX200900	AX200421
LC duplex-ST, 3 m (10 ft.)	AX200699	AX200695	AX200809	AX200698
LC duplex-568SC, 3 m (10 ft.)	AX200580	AX200581	AX200668	AX200667
MTRJ-ST, 3 m (10 ft.)	AX101133	AX101151	AX200810	AX101166
MTRJ-568SC, 3 m (10 ft.)	AX101128	AX101143	AX200797	AX101161
Single-ended (pigtailed)				
ST-open, 2 m (6 ft.)	70100390	AX200458	AX200811	AX200097
SC-open, 2 m (6 ft.)	70101714	AX200192	AX200653	AX200098
LC-open, 2 m (6 ft.)	AX200657	AX200658	AX200660	AX200659
MTRJ(m)-open, 3 m (10 ft.)	AX101366	AX101367	AX200812	AX101368

Also available as Simplex Patch Cords or custom assemblies, please contact Customer Service for more details.

These products are in the process of being assessed for RoHS compliance. Please check our Web Site for the most current RoHS status.

FiberExpress Pre-Connectorized Assemblies

Cable Assemblies

AX250105 MPO Cable Assembly



Multi-fiber Cable Assembly



900 μm Fan-out Assembly

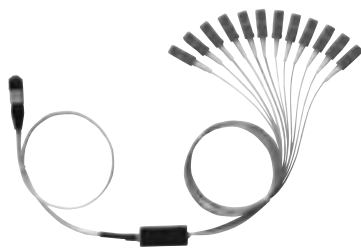

MPO Cable Assembly

MPO Cable Assemblies are multi-fiber cables using single MPO connectors 6, 8 and 12-fiber that are used to interconnect pre-terminated devices such as FiberExpress Pre-terminated Modules and FiberExpress Bars. Depending on the application, MPO Cable Assemblies can use Ribbon Cables or Loose Tube cables. MPO cables are available in lengths of up to 500 meters with a pulling-eye for ease of deployment.

Multi-fiber Cable Assembly

Multi-fiber Cable Assemblies are factory-terminated fiber cables of various constructions (distribution, breakout or ribbon) using simplex, duplex or multi-fiber connectors. They are available in configurations from 2-fiber up to 144-fiber with various kinds of fan-out constructions, lengths and geometry to suit virtually any application.

Description	Belden Part Number	
	Multimode, FX300, 62.5 μm	Multimode, FX600, 50 μm

FiberExpress Pre-Connectorized Assemblies

MPO Cable Assembly, FOMC, MPO(f)-MPO(f)		
1 pulling eye, OFNP, 12 fibers, 10 m (33 ft.)	AX250021	AX250345
1 pulling eye, OFNP, 12 fibers, 20 m (66 ft.)	AX250105	AX250376
1 pulling eye, OFNP, 12 fibers, 50 m (164 ft.)	AX250349	AX250065
1 pulling eye, OFNP, 12 fibers, 75 m (246 ft.)	AX250060	AX250066
1 pulling eye, OFNP, 12 fibers, 100 m (328 ft.)	AX250061	AX250067
		Multimode, FX2000, 50 μm
1 pulling eye, OFNP, 12 fibers, 10 m (33 ft.)	AX250457	AX250224
1 pulling eye, OFNP, 12 fibers, 20 m (66 ft.)	AX250412	AX250106
1 pulling eye, OFNP, 12 fibers, 50 m (164 ft.)	AX250387	AX250071
1 pulling eye, OFNP, 12 fibers, 75 m (246 ft.)	AX250413	AX250072
1 pulling eye, OFNP, 12 fibers, 100 m (328 ft.)	AX250458	AX250073
		Single-mode

Also available in 6 or 8-fiber MPO Cable Assemblies, please contact Customer Service for more details.

Multi-fiber Cable Assembly, MPO(m)-ST	
Multimode FX300, 62.5 μm, 12 fibers	NXC-RPML-PGPNNN-STPFBN-N-01.5
Multimode FX600, 50 μm, 12 fibers	NXC-RPNL-PGPNNN-STPFBN-N-01.5
Multimode FX2000, 50 μm, 12 fibers	NXC-RPFL-PGPNNN-STPFBN-N-01.5
Single-mode, 12 fibers	NXC-RPSL-PGANNN-STSFBN-N-01.5
Multi-fiber Cable Assembly, MPO(m)-SC	
Multimode FX300, 62.5 μm, 12 fibers	NXC-RPML-PGPNNN-SCPFBN-N-01.5
Multimode FX600, 50 μm, 12 fibers	NXC-RPNL-PGPNNN-SCPFBN-N-01.5
Multimode FX2000, 50 μm, 12 fibers	NXC-RPFL-PGPNNN-SCPFBN-N-01.5
Single-mode, 12 fibers	NXC-RPSL-PGANNN-SCSFBN-N-01.5
Multi-fiber Cable Assembly, MPO(m)-LC	
Multimode, FX300, 62.5 μm, 12 fibers	NXC-RPML-PGPNNN-LCPFBN-N-01.5
Multimode FX600, 50 μm, 12 fibers	NXC-RPNL-PGPNNN-LCPFBN-N-01.5
Multimode FX2000, 50 μm, 12 fibers	NXC-RPFL-PGPNNN-LCPFBN-N-01.5
Single-mode, 12 fibers	NXC-RPSL-PGANNN-LCSFBN-N-01.5
Multi-fiber Cable Assembly, MPO(m)-MTRJ(m)	
Multimode FX300, 62.5 μm, 12 fibers	NXC-RPML-PGPNNN-JBPFBN-N-01.5
Multimode FX600, 50 μm, 12 fibers	NXC-RPNL-PGPNNN-JBPFBN-N-01.5
Multimode FX2000, 50 μm, 12 fibers	NXC-RPFL-PGPNNN-JBPFBN-N-01.5
Single-mode, 12 fibers	NXC-RPSL-PGANNN-JBSFBN-N-01.5

These products are in the process of being assessed for RoHS compliance. Please check our Web Site for the most current RoHS status.

FiberExpress Pre-Connectorized Assemblies

FiberExpress Bar

AX250001 FiberExpress Bar 12ST

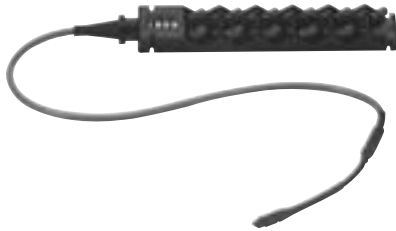

MX100154 FiberExpress MPO Adapter



FiberExpress Bar

The **FiberExpress Bar** consists of a custom length fiber cable with, at one end, a factory pre-terminated rugged mini patch panel and, at the other end, a factory installed multi-fiber MPO connector. The very compact fiber patch panel contains 6 or 12 factory-terminated and tested connectors in a variety of styles. The ruggedness of the FiberExpress Bar makes it an ideal candidate for disaster recovery, industrial applications and other fiber deployment in harsh environment.

FiberExpress Bar Accessories

The **MPO Adapter** is the sleeve that provides primary alignment and locking when connecting the two MPO connectors (male to female). It has a flange and a metal clip for panel mounting and it is included with each FiberExpress Bar (1m with male connector).

The **19 in. Rack Mount Housing** is a 1U metal panel that holds 1 FiberExpress Bar. It has a live hinge on the left-hand side and swings out giving access to the MPO connection and facilitate cable management and slack storage when used with the Slack Storage Tray.

The **Front Cover** is a smoked Plexiglas cover that protects the fiber cords connected to the FiberExpress Bar. It has 2 push rivets for positive locking and easy handling.

The **Slack Storage Tray** attaches to the back of the 19 in. Rack Mount Housing to facilitate cable management and slack storage. It has a storage capacity of 5 meters of 12-fiber ribbon cable.

The **Wall Mount Enclosure** can contain one FiberExpress Bar. It is made of heavy gauge steel and has a locking cover.

Description	Belden Part Number	
	Multimode, FX300, 62.5 μm	Multimode, FX600, 50 μm

FiberExpress Pre-Connectorized Assemblies

FiberExpress Bar		
12 ST type, MPO (m), 1 m	AX250001	AX250052
6 SC duplex, MPO (m), 12 fibers, 1 m	AX250005	AX250054
6 MT-RJ, MPO (m), 12 fibers, 1 m	AX250178	AX250179
12 LC, MPO (m), 1 m	AX250539	AX250540
	Multimode, FX2000, 50 μm	Single-mode
12 ST type, MPO (m), 1 m	AX250459	AX250009
6 SC duplex, MPO (m), 12 fibers, 1 m	AX250460	AX250011
6 MT-RJ, MPO (m), 12 fibers, 1 m	AX250461	AX250180
12 LC, MPO (m), 1 m	AX250541	AX250542

Also available for 6 fibers, please contact Customer Service for more details.

FiberExpress Bar Accessories	
MPO Adapter (6 or 12 fibers) included with each FiberExpress Bar (1 m - Male)	MX100154
19 in. Rack Mount Housing for FiberExpress Bar, Gray	AX100331
19 in. Rack Mount Housing for FiberExpress Bar, Black	AX100330
Front Cover for FiberExpress rack mount housing	AX100332
Slack Storage Tray for FiberExpress Bar, (capacity: 5 meters) including top cover, Gray	AX100329
Slack Storage Tray for FiberExpress Bar, (capacity: 5 meters) including top cover, Black	AX100328
Wall Mount Enclosure, can contain one bar, Black	AC200004

These products are in the process of being assessed for RoHS compliance. Please check our Web Site for the most current RoHS status.

FiberExpress Secure/Keyed LC System

Optimax Field Installable Connectors and Patch Cords & Pigtails

AX102197 Secure/Keyed LC Optimax



Secure/Keyed LC System

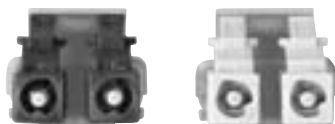

FiberExpress Secure/Keyed LC System

The **FiberExpress Secure/Keyed LC System** allows for physical segregation of networks segments in secure fiber cabling infrastructures. All Secure/Keyed LC products are available with 6 different keying options each carrying a different color to facilitate network administration. The keying detail inside the connector is totally tamper-resistant and cannot be re-produced inside a standard LC connector to violate the network security. All products comply with the FOCIS 10 standard and optical performance exceeds all industry standards for SFF connectors.

The **Secure/Keyed LC Optimax field installable connectors** are available in Multimode 50 µm laser-optimized and 62.5 µm fiber versions. They are high-quality connectors that use a ceramic ferrule with a physical contact (PC) polish for Multimode connectors.

The **Secure/Keyed LC Patch Cords and Pigtails** are offered in Multimode 62.5 µm (FX300), 50/125 µm (FX600) and laser-optimized 50/125 µm (FX2000) for the most demanding network performance.

Description	Belden Part Number					
	K1, Red	K2, Green	K3, Yellow	K4, Black	K5, Orange	K6, Blue

FiberExpress Secure/Keyed LC System

Secure/Keyed LC Optimax*						
Multimode 62.5 µm**	AX102203	AX102204	AX102205	AX102206	AX102207	AX102208
Multimode 50 µm**	AX102197	AX102198	AX102199	AX102200	AX102201	AX102202

**For 900 µm buffered fiber only. The same accessory kit (AX101984) is used for 2 mm jacketed cable connector termination as for our regular Optimax LC offering.

Secure/Keyed LC Duplex Patch Cord, KEYx-KEYx*						
2 m (6 ft.), Multimode FX300, 62.5 µm	AX201365	AX201366	AX201367	AX201368	AX201369	AX201370
2 m (6 ft.), Multimode FX600, 50 µm	AX201383	AX201384	AX201385	AX201386	AX201387	AX201388
2 m (6 ft.), Multimode FX2000, 50 µm	AX201401	AX201402	AX201403	AX201404	AX201405	AX201406
3 m (10 ft.), Multimode FX300, 62.5 µm	AX201371	AX201372	AX201373	AX201374	AX201375	AX201376
3 m (10 ft.), Multimode FX600, 50 µm	AX201389	AX201390	AX201391	AX201392	AX201393	AX201394
3 m (10 ft.), Multimode FX2000, 50 µm	AX201407	AX201408	AX201409	AX201410	AX201411	AX201412
5 m (16 ft.), Multimode FX300, 62.5 µm	AX201377	AX201378	AX201379	AX201380	AX201381	AX201382
5 m (16 ft.), Multimode FX600, 50 µm	AX201395	AX201396	AX201397	AX201398	AX201399	AX201400
5 m (16 ft.), Multimode FX2000, 50 µm	AX201413	AX201414	AX201415	AX201416	AX201417	AX201418

Secure/Keyed LC Duplex Hybrid Patch Cord, KEYx-LCD*						
2 m (6 ft.), Multimode FX300, 62.5 µm	AX201419	AX201420	AX201421	AX201422	AX201423	AX201424
2 m (6 ft.), Multimode FX600, 50 µm	AX201437	AX201438	AX201439	AX201440	AX201441	AX201442
2 m (6 ft.), Multimode FX2000, 50 µm	AX201455	AX201456	AX201457	AX201458	AX201459	AX201460
3 m (10 ft.), Multimode FX300, 62.5 µm	AX201425	AX201426	AX201427	AX201428	AX201429	AX201430
3 m (10 ft.), Multimode FX600, 50 µm	AX201443	AX201444	AX201445	AX201446	AX201447	AX201448
3 m (10 ft.), Multimode FX2000, 50 µm	AX201461	AX201462	AX201463	AX201464	AX201465	AX201466
5 m (16 ft.), Multimode FX300, 62.5 µm	AX201431	AX201432	AX201433	AX201434	AX201435	AX201436
5 m (16 ft.), Multimode FX600, 50 µm	AX201449	AX201450	AX201451	AX201452	AX201453	AX201454
5 m (16 ft.), Multimode FX2000, 50 µm	AX201467	AX201468	AX201469	AX201470	AX201471	AX201472

Secure/Keyed LC Duplex Hybrid Patch Cord, KEYx-SCD*						
2 m (6 ft.), Multimode FX300, 62.5 µm	AX201473	AX201474	AX201475	AX201476	AX201477	AX201478
2 m (6 ft.), Multimode FX600, 50 µm	AX201491	AX201492	AX201493	AX201494	AX201495	AX201496
2 m (6 ft.), Multimode FX2000, 50 µm	AX201509	AX201510	AX201511	AX201512	AX201513	AX201514
3 m (10 ft.), Multimode FX300, 62.5 µm	AX201479	AX201480	AX201481	AX201482	AX201483	AX201484
3 m (10 ft.), Multimode FX600, 50 µm	AX201497	AX201498	AX201499	AX201500	AX201501	AX201502
3 m (10 ft.), Multimode FX2000, 50 µm	AX201515	AX201516	AX201517	AX201518	AX201519	AX201520
5 m (16 ft.), Multimode FX300, 62.5 µm	AX201485	AX201486	AX201487	AX201488	AX201489	AX201490
5 m (16 ft.), Multimode FX600, 50 µm	AX201503	AX201504	AX201505	AX201506	AX201507	AX201508
5 m (16 ft.), Multimode FX2000, 50 µm	AX201521	AX201522	AX201523	AX201524	AX201525	AX201526

Secure/Keyed LC Pigtail, KEYx-open*						
2 m (6 ft.), Multimode FX300, 62.5 µm	AX201527	AX201528	AX201529	AX201530	AX201531	AX201532
2 m (6 ft.), Multimode FX600, 50 µm	AX201533	AX201534	AX201535	AX201536	AX201537	AX201538
2 m (6 ft.), Multimode FX2000, 50 µm	AX201539	AX201540	AX201541	AX201542	AX201543	AX201544

Other Patch Cord lengths and configurations may be available, please contact Customer Service for more details.

These products are in the process of being assessed for RoHS compliance. Please check our Web Site for the most current RoHS status. * Patent Pending.



FiberExpress Secure/Keyed LC System

Adapter Modules, Adapter Strips and FiberExpress Manager Modules

AX102098 Secure/Keyed LC Adapter Module

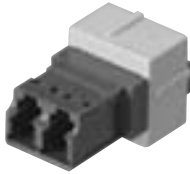

AX102124 Secure/Keyed LC Adapter Strip



AX102114 Secure/Keyed LC FiberExpress Manager Module

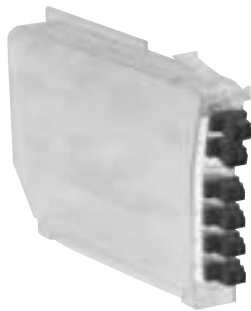

FiberExpress Secure/Keyed LC System

The **FiberExpress Secure/Keyed LC System** allows for physical segregation of networks segments in secure fiber cabling infrastructures. All Secure/Keyed LC products are available with 6 different keying options each carrying a different color to facilitate network administration. The keying detail inside the connector is totally tamper-resistant and cannot be re-produced inside a standard LC connector to violate the network security. All products comply with the FOCIS 10 standard and optical performance exceeds all industry standards for SFF connectors.

The **Secure/Keyed LC Adapter Modules and Adapter Strips** can be used in all mounting hardware for workstation area, Consolidation Point or Telecom Room applications.

The **Secure/Keyed LC FiberExpress Manager Modules** can be used in 19 and 23 inch *FiberExpress* Manager Shelves to provide a high-density management system of up to 1920 terminated fibers per rack.

Description	Belden Part Number					
	K1, Red	K2, Green	K3, Yellow	K4, Black	K5, Orange	K6, Blue
FiberExpress Secure/Keyed LC System						
Secure/Keyed LC Adapter Module*						
Gray holder	AX102089	AX102090	AX102091	AX102092	AX102093	AX102094
Almond holder	AX102095	AX102096	AX102097	AX102098	AX102099	AX102100
White holder	AX102101	AX102102	AX102103	AX102104	AX102105	AX102106
Black holder	AX102107	AX102108	AX102109	AX102110	AX102111	AX102112
Secure/Keyed LC FiberExpress Adapter Strip*						
12 fibers	AX102119	AX102120	AX102121	AX102122	AX102123	AX102124
24 fibers	AX102125	AX102126	AX102127	AX102128	AX102129	AX102130
Secure/Keyed LC FiberExpress Manager Module*						
12 fibers	AX102113	AX102114	AX102115	AX102116	AX102117	AX102118
24 fibers	AX102310	AX102311	AX102312	AX102313	AX102314	AX102315

* Patent Pending.

These products are in the process of being assessed for RoHS compliance. Please check our Web Site for the most current RoHS status.

FiberExpress Manager

Rack Components and Modules

AX100934 FiberExpress Manager Shelf



AX101943 FiberExpress Manager 1U Rack Mount Patch Panel



AX102032 FiberExpress Manager 1U Cable Management Accessory



AX101525 Connector Module Pre-terminated MPO-MT-RJ

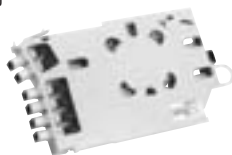

FiberExpress Manager Shelf

FiberExpress modules are rack-mounted using FiberExpress Manager Shelves. The shelves provide the total system with extra high connection density while facilitating cable routing and patch cord management. For 19- or 23-inch rack: 19 in. shelf holds up to 12 modules; 23 in. shelf holds up to 16 modules.

FiberExpress Manager 1U

The **FiberExpress Manager 1U Rack Mount Patch Panel** is a low-cost, compact assembly designed for interconnection or splicing of optical fiber cables, using up to three FiberExpress Manager Modules. The low-profile design minimizes rack space to only 45 mm (1.75 in.). An optional FiberExpress Manager 1U Cable Management Accessory is also available.

FiberExpress Manager Connector Module

The **Connector Module** is the basic building block of the FiberExpress Manager. It is designed with a unique release mechanism that allows it to slide from the shelf like a PC card, easing management of patch cords.

Description	Belden Part Number	
	Gray	Black
FiberExpress Manager		
FiberExpress Manager		
Shelf, 23 in., 10.9 kg (24 lb)	AX100934	AX100935
Shelf, 19 in., 8.2 kg (18 lb)	AX101084	AX101085
1U, Rack Mount Patch Panel, 19 in., 5 kg (11 lb)	AX101944	AX101943
1U, Cable Management Accessory, 19 in., 1 kg (2 lb)	AX102033	AX102032

Description	Belden Part Number					
	ST Type	SC Simplex	SC Duplex	SC Duplex (ST in)	LC	FC
FiberExpress Manager						
FiberExpress Manager Connector Module						
Metal Sleeve, Multimode, 6 fibers	AX101089		AX101092			
Zirconia Ceramic, Single-mode, 6 fibers	AX100936	AX100943	AX100944			
Metal Sleeve, Multimode, 12 fibers	AX101187		AX101714	AX101120	AX101528	
Zirconia Ceramic, Single-mode, 12 fibers	AX101186		AX101713	AX101119	AX101527	
Zirconia Ceramic, Single-mode, 12 UPC pigtails			AX101715			
Metal Sleeve, Multimode, 24 fibers					AX102306	
Zirconia Ceramic, Single-mode, 24 fibers					AX102305	
Zirconia Ceramic, Single-mode/Multimode, 6 fibers						AX100937
		Multimode 62.5 µm	Multimode 50 µm	Single-mode		
MPO(m)-ST type, 12 pre-terminated	AX101189		AX101190	AX101188		
MPO(m)-SC Duplex, 12 pre-terminated	AX101091		AX101114	AX101090		
MPO(m)-MT-RJ(m), 12 pre-terminated	AX101525		AX101526	AX101524		
MPO(m)-LC, 12 pre-terminated	AX101530		AX101531	AX101529		
MPO(m)-LC, 24 pre-terminated	AX102309		AX102308	AX102307		
MT-RJ, Beige, Multimode, 12 fibers						AX101096
MT-RJ, Blue, Single-mode, 12 fibers						AX101581

These products are in the process of being assessed for RoHS compliance. Please check our Web Site for the most current RoHS status.

FiberExpress Patch Panels

Rack Mount Patch Panels

AX100041 FiberExpress, 12/24 Port (1U)
Rack Mount Patch Panel



AX100069 FiberExpress, 24/48 Port (2U)
Rack Mount Patch Panel

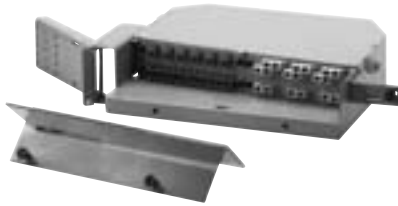

AX100078 FiberExpress (3U) Rack Mount Patch Panel



AX100115 FiberExpress, 48/96 Port (4U) Rack Mount
Patch Panel



FiberExpress Rack Mount Patch Panel 1U and 2U

The **FiberExpress 1U and 2U Rack Mount Patch Panels** are equipped with a special hinge that allows easy access to the rear of the patch panel without disturbing the optical fiber cable. A specially designed front panel allows connector protection and easy routing of optical fiber patch cords. The **FiberExpress** Rack Mount Patch Panels are also compatible with our 203 mm (8 in.) Splice Organizer Trays. This allows the optical fiber cable to be either terminated with fiber single-ended patch cords or field-installable connectors. The patch panels can be used with ST Compatible, SC, 568SC, FC, LC or MT-RJ adapters strips (ordered separately).

The **FiberExpress 1U Rack Mount Patch Panel** is a low-cost, compact assembly designed for interconnection or splicing of optical fiber cables, from 12 up to 48 fibers if MT-RJ or LC double density adapter strips are used. The low-profile design minimizes rack space to only 45 mm (1.75 in.). An optional smoked Plexiglass front cover is also available.

The **FiberExpress 2U Rack Mount Patch Panel** offers a high fiber capacity, 96 fibers if using double density MT-RJ or LC adapter strips. The **FiberExpress 2U** comes equipped with a smoked Plexiglass front cover that protects fiber connections while allowing for quick visual inspection.

FiberExpress Rack Mount Patch Panel 3U

The **FiberExpress 3U Rack Mount Patch Panel** can accommodate up to 96 optical fiber connections using MT-RJ or LC connectors. The connector panel is mounted on a sliding drawer for easy access to the back side (cable side) of the panel. The **FiberExpress 3U Rack Mount Patch Panel** can be used with either optical fiber single-ended patch cords or field-installable connectors. If optical single-ended patch cords are to be used, organizer trays are easily accessible via the removable front access pull-out drawer. (Trays must be ordered separately.)

The **FiberExpress 3U Rack Mount Patch Panel** is a compact cross-connect assembly for the termination of optical fiber cables. The low-profile design minimizes required rack space to 127 mm (5 in.). It is compatible with ST Compatible, SC, 568SC, MT-RJ, LC and FC adapters strips (ordered separately).

FiberExpress Rack Mount Patch Panel 4U

The **FiberExpress 4U Rack Mount Patch Panel** is an economical solution for the protection of optical fiber terminations and splices, up to 192 optical fibers if using MT-RJ or LC connectors. The connector panel, accepting the Universal Adapter Strips, is located inside the enclosure and swings out (left or right) to give easy access to the cable and splices.

The **FiberExpress 4U Rack Mount Patch Panel** is a compact Cross-Connect enclosure for the cross-connection, interconnection or splicing of optical fiber cables. The low-profile design minimizes required rack space to 178 mm (7 in.). It can be used with ST Compatible, SC, 568SC, MT-RJ, LC and FC adapters strips (ordered separately).

Description	Belden Part Number
FiberExpress Patch Panels	
FiberExpress Rack Mount Patch Panel 1U*	
Gray	AX100042
Black	AX100041
FiberExpress Rack Mount Patch Panel 2U*	
Gray	AX100069
Black	AX100068
FiberExpress Rack Mount Patch Panel 3U	
Gray	AX100078
Black	AX100077
FiberExpress Rack Mount Patch Panel 4U	
Gray	AX100115
Black	AX100116

If Single-ended patch cords are to be spliced to the fiber cable, don't forget to order Splice Organizer Trays or Kits. Both these, and the Universal Adapter Strips can be ordered in the **FiberExpress Accessories** section.

*IMPORTANT: The **FiberExpress 1U** accepts two (2) 203 mm (8 in.) splice trays.
The **2U** accepts four (4) 203 mm (8 in.) splice trays.

These products are in the process of being assessed for RoHS compliance. Please check our Web Site for the most current RoHS status.

FiberExpress Patch Panels

Rack Mount Accessories and Wall Mount Patch Panels

AX101800 127 mm (5 in.) Universal Offset Bracket Kit, for 19 in. and 23 in. Racks 1U

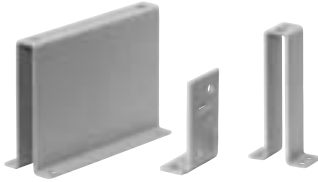

AX101802 23 in. Rack Universal Extension Bracket for 1U and 2U



AX100047 Right Side Cable Entry Bracket for 1U



AX100045 Front Cover for 1U



AX100543 Large Wall Mount



FiberExpress Rack Mount Patch Panels 1U and 2U Accessories

The accessories provide additional panel mounting flexibility for racks, cabinets and cable entry.

Description	Belden Part Number
FiberExpress Patch Panels	
Rack Mount Accessories (1U and 2U)	
127 mm (5 in.) Universal Offset Bracket Kit:	
for 19 in. and 23 in. racks (1U), Black	AX101799
for 19 in. and 23 in. racks (1U), Gray	AX101800
for 19 in. and 23 in. racks (2U), Black	AX101797
for 19 in. and 23 in. racks (2U), Gray	AX101798
23 in. Universal extension bracket, Black	AX101801
23 in. Universal extension bracket, Gray	AX101802
Right side cable entry bracket (1U), Black	AX100046
Right side cable entry bracket (1U), Gray	AX100047
Right side cable entry bracket (2U), Black	AX100073
Right side cable entry bracket (2U), Gray	AX100074
Front Cover (1U), Smoked Plexiglass	AX100045

FiberExpress Wall Mount Patch Panel

The FiberExpress Wall Mount Patch Panel Series is an economical solution for the protection of optical fiber terminations and splices in hostile environments.

Using the FiberExpress Universal Adapter Strips (ordered separately), the Wall Mount Patch Panels allow for flexible and customized patch panel design. They are compatible with most industry standard connections: ST Compatible, SC, 568SC, MT-RJ, LC and FC.

Available in gray and black, the FiberExpress Wall Mount Patch Panels have an ergonomic design, rugged construction and compact assemblies to effectively protect your optical fiber terminations and splices.

Description	Belden Part Number
FiberExpress Patch Panels	
Wall Mount	
Small, Gray	AX100496
Small, Black	AX100495
Medium, Gray	AX100541
Medium, Black	AX100540
Large, Gray	AX100543
Large, Black	AX100542

If optical Single-ended patch cords are to be spliced to the fiber cable, don't forget to order Splice Organizer Trays or Kits in FiberExpress Accessories section. Universal Adapter Strips can be ordered in FiberExpress Patch Panels section.

These products are in the process of being assessed for RoHS compliance. Please check our Web Site for the most current RoHS status.

AX100541 Medium Wall Mount



AX100495 Small Wall Mount



FiberExpress Patch Panels Accessories

Universal Optical Fiber Adapter Strips and Accessories

AX101729 Adapters loaded with 6 LC Duplex



AX100094 Adapters loaded with 3 SC Duplex



AX100066 Blank Strip



AX101100 Field Breakout Kit

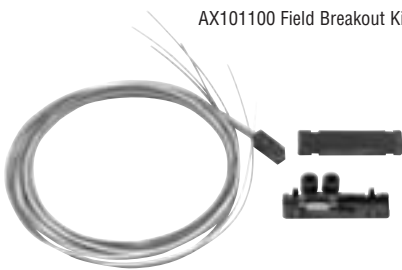

A0649869 Optical Fiber Splice Organizer Kits and Trays



AX100945 Flex Kit



AX101098 Splice Holder Kit

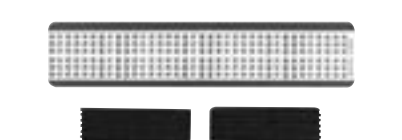

Optical Fiber Adapter Strips

Universal Optical Fiber Adapter Strips are pre-loaded with six (single density) or 12 (double density) adapter sleeves. Two types of adapter sleeves are available: Phosphor Bronze and Zirconia Ceramic. Adapter sleeves are used as the connecting interface between two optical fiber connectors.

A **Blank adapter strip** is also available and can be used with any FiberExpress Patch Panel to fill in unused adapter strip openings.

Optical Fiber Accessories

The Field Breakout Kit is designed to attach to one tube of a loose-tube cable. Each kit has either six or twelve 900 µm tubes that hold each of the coated fibers. For each end of the cable, one kit is needed for every tube. For example, a 12-fiber 62.5 µm cable contains two 6-fiber tubes. This cable would require four kits, two for each end.

Optical Fiber Splice Organizer Kits provide the accessories necessary for installing the FiberExpress Fiber Patch Panels, as well as other fiber terminals that accommodate the standard Belden organizer tray.

The Flex Kit contains tubes and manifolds designed to split cables into individual fiber strands, and is suitable for 6 fibers up to 12 fibers. It is necessary for use with loose tube cables or when the fiber cable count does not match the number of connections in the FiberExpress Manager Connector Module. The Flex Kit tubes help to maintain proper fiber bend radius. One kit is required per 12 modules (one 19 in. shelf).

A **Splice Holder Kit** can be used to hold fusion or mechanical splices. Each splice holder can handle up to 6 splices.

Description	Belden Part Number	
	Phosphor Bronze, Multimode	Zirconia Ceramic, Single-mode

FiberExpress Optical Fiber Adapter Strips

Single Density, Black		
Loaded with 6 ST Compatible Adapters	AX100088	AX100534
Loaded with 3 SC Duplex Adapters	AX100094	AX101407
Loaded with 6 SC Simplex Adapters	AX100092	AX100538
Loaded with 6 FC Adapters	AX100090	AX100536
Loaded with 6 LC Duplex Adapters	AX101729	AX101731
MT-RJ, loaded with 6 MT-RJ, Multimode/Single-mode	AX101115	
Double Density, Black		
Loaded with 12 ST Compatible Adapters	AX100080	AX100528
Loaded with 6 SC Duplex Adapters	AX100098	AX101409
Loaded with 12 SC Simplex Adapters	AX100084	AX100532
Loaded with 12 FC Adapters	AX100082	AX100530
Loaded with 12 LC Duplex Adapters	AX101741	AX101743
MT-RJ, loaded with 12 MT-RJ, Multimode/Single-mode	AX101117	
Blank Strip		
Black	AX100066	

FiberExpress Accessories

Optical Fiber Field Breakout Kit	
6 fibers, 1/pack	AX101100
12 fibers, 1/pack	AX101101
Optical Fiber Splice Organizer Kit	
Splice kit, tray, 203 mm (8 in.)	A0649869
Splice kit, tray, 305 mm (12 in.)	A0318904
Optical Fiber Splice Tray	
Fusion, 203 mm (8 in.)	A0335015
Fusion, 305 mm (12 in.)	A0316446
Universal (mechanical or fusion), 203 mm (8 in.)	AX100079
Universal (mechanical or fusion), 305 mm (12 in.)	A0394328
Tray cover, 203 mm (8 in.)	A0394331
Tray cover, 305 mm (12 in.)	A0394330
Flex Kit	AX100945
Splice Holder Kit	AX101098

These products are in the process of being assessed for RoHS compliance. Please check our Web Site for the most current RoHS status.



FiberExpress Outlets

MediaFlex Plates and Inserts

AX101869 MediaFlex Plate, Double Gang

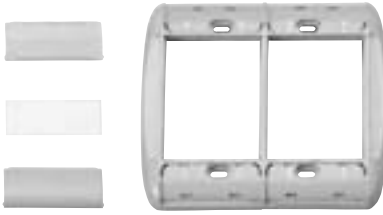

AX101874 MediaFlex Adapter Box, Double Gang

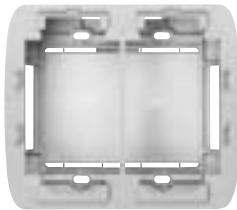

AX101756 MediaFlex MDVO (style) Insert, 2-port, Angled

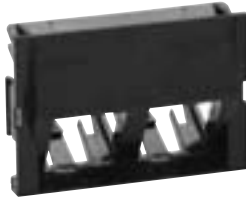

AX101937 MediaFlex SC Duplex Insert, Angled

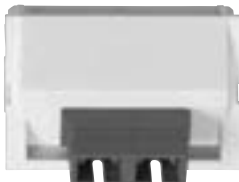

MediaFlex Plate

MediaFlex Plates are one part of the comprehensive line of plates and inserts that snap together to create a full line of modular workstation outlets.

MediaFlex Plates can be mounted over standard NEMA type outlet boxes and rings to provide support for a variety of MediaFlex Adapters and Inserts. The fully modular construction combined with the front access design provides extensive configuration flexibility for current and future network needs. MediaFlex Plates are available in Single Gang and Double Gang configurations.

The Double Gang faceplate comes with a stand-off ring included in the package. This ring allows for easy mounting with virtually any industry electrical box or mud/adaptor rings, therefore providing added installation flexibility.

Each plate has the capacity of up to 6 ports per Single Gang and 12 ports per Double Gang.

MediaFlex Adapter Box

MediaFlex Surface Adapter Boxes are one part of the comprehensive line of plates and inserts that snap together to create a full line of modular workstation outlets.

MediaFlex Surface Adapter Boxes can be mounted over standard NEMA type outlet boxes and rings to provide support for the MediaFlex plates. The MediaFlex Surface Adapter Boxes are available as a Double Gang configuration. The Double Gang box allows more room for cable management and bend radius control.

MediaFlex MDVO (style) Insert

MediaFlex MDVO-style Inserts are available in a 2-port configuration in both Flush and Angled versions. They are compatible with all GigaFlex and MDVO Modules (EZ-MDVO and Multimedia). The inserts are two units high for the flush version and three units high for the angled version. Therefore three flush inserts or two angled inserts are required to fully populate a Single Gang MediaFlex Plate.

MediaFlex Multimedia Insert

MediaFlex Multimedia Inserts provide optimum flexibility in configuring multimedia workstation outlets that respond to any present or future network needs. MediaFlex Multimedia Inserts along with other MediaFlex Inserts allow for easy configuration of outlets. All inserts are front loaded and easily snapped in and out of the MediaFlex Plates for easy installation and maintenance.

MediaFlex Multimedia Inserts are available in Angled versions only in order to allow for proper management of cable bend radius. The inserts are three units high, therefore two inserts are required to fully populate a Single Gang faceplate and four inserts will fully populate a Double Gang faceplate.

Description	Belden Part Number					
	Gray	Almond	Elec. White	Black	White	Ivory
FiberExpress Outlets						
MediaFlex Plate						
Single Gang	AX101745	AX101746	AX101747	AX101748	AX102608	AX102569
Double Gang	AX101869	AX101870	AX101871	AX101872	AX102609	AX102570
MediaFlex Adapter Box						
Single Gang	AX102480	AX102481	AX102482	AX102483	AX102484	AX102485
Double Gang	AX101873	AX101874	AX101875	AX101876	AX102610	AX102571
MediaFlex MDVO (style) Insert						
2-port, Flush, bag of 10 units	AX101749	AX101750	AX101751	AX101752	AX102612	AX102572
2-port, Angled, bag of 10 units	AX101753	AX101754	AX101755	AX101756	AX102613	AX102573
MediaFlex SC Duplex						
SC Duplex Single-mode	AX101935	AX101936	AX101937	AX101938	AX102619	AX102649
SC Duplex Multimode	AX101939	AX101940	AX101941	AX101942	AX102620	AX102650

These products are in the process of being assessed for RoHS compliance. Please check our Web Site for the most current RoHS status.



FiberExpress Outlets

MDVO Multimedia Outlet Boxes & Modules and Multi-User Outlet Boxes

A0643205 MDVO Multimedia Outlet Box, shown here as terminated

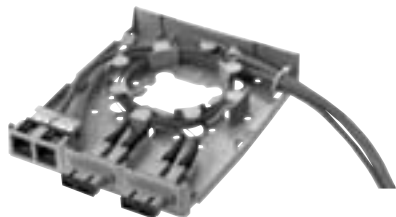

A0407005 MDVO SC Fiber Module

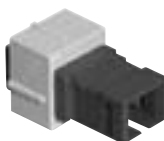

A0649254 SC Duplex Adapter



A0407010 MDVO ST Compatible Fiber Module



AX101467 MDVO MT-RJ Fiber Module



AX100222 Multi-User Outlet Box, shown here with modules



MDVO Multimedia Outlet Box

The **MDVO Multimedia Outlet Box** brings unique versatility for multimedia work area installations. The box design provides cable management and helps maintain cable bend radius. The outlet box's low profile design and side-entry offers better protection for patch cords. The outlet box can accept up to six EZ-MDVO, GigaFlex or MDVO Multimedia Modules or three SC Duplex adapters.

The MDVO Multimedia Outlet Box can be mounted directly on the wall or attached to standard electrical boxes. Included with the MDVO Multimedia box are three SC Duplex Mounting bezels and three MDVO Adapters.

MDVO Multimedia Modules

MDVO Multimedia Modules address audio/video and fiber applications. Fiber modules are available for LC Duplex, SC Simplex, ST Compatible multimode and MT-RJ multimode & single-mode connections. The SC Duplex Adapter is a fiber adapter sleeve with flanges that mounts into the SC Duplex mounting bezel (included in the MDVO Multimedia Outlet box). Audio/video modules are available for SVHS, RCA, BNC and Video F connections.

Multi-User Outlet Box

The **Multi-User Outlet Box** is a versatile box that can be used in many different applications. The outlet box can accommodate up to 24 connections of any type, UTP, fiber or coax. The outlet box is ideal for use as a multi-user telecommunications assembly, or simply as a high-density multimedia telecommunications outlet. The Multi-User Outlet Box can also be used as a wall mounted patch panel in confined areas, such as shallow rooms and cabinets.

Description	Belden Part Number			
	Gray	Almond	White	Black

FiberExpress Outlets

MDVO Multimedia Outlet Box				
6-port	A0643205	A0643206	A0643207	A0643208
Please note that SC Duplex adapters must be ordered separately (A0649254).				
MDVO Multimedia Module				
LC Duplex Multimode	AX102209	AX102210	AX102211	AX102212
LC Duplex Single-mode	AX102213	AX102214	AX102215	AX102216
SC Simplex, Multimode, Blue insert	A0407003	A0407004	A0407005	A0407006
SC Duplex Adapter, Multimode	A0649254			
ST Compatible, Multimode	A0407007	A0407008	A0407009	A0407010
MT-RJ, Multimode	AX101467			
MT-RJ, Single-mode, Blue	AX101466			

Custom multimedia connectors are also available, please contact Customer Service for more details.

Multi-User Outlet Box				
24-port	AX100219	AX100220	AX100221	AX100222

These products are in the process of being assessed for RoHS compliance. Please check our Web Site for the most current RoHS status.

Network Connectivity Products

Media Converters, Transceivers & Hubs and Network Tester

Media Converters

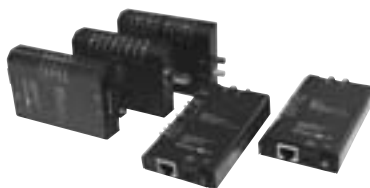

Media Converters for Ethernet and Fast Ethernet

Media Converters enable the connection of dissimilar network cabling types, while maintaining the same network speed. A legacy Thinnet segment can be connected to a 10Base-T Hub or switch port with an AX-200 Converter or, link two different 10Base-T networks together over a multimode fiber optic link with a pair of AX-270s. Connect a legacy Thinnet segment over fiber with the AX-280 converter. The AX-5270 can be used for interbuilding links or attached to a fiber backbone.

AX-1912 Media Converter Rack

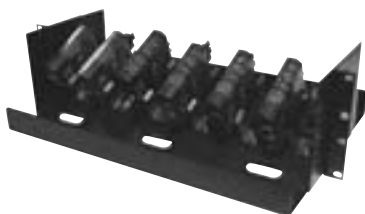

Transceivers and Ethernet Hubs

The AX-50, 70 and 80 Transceivers enable the connection of a legacy AUI port to 10Base-T, Thinnet, or Fiber Optic media. The transceiver is powered from the host and requires no external power supply.

The AX-509 Ethernet Hub has an AUI port which accepts UTP, Fiber Optic or BNC transceivers. Specified for use by many U.S. Government Agencies. Includes a 110v/12v power supply.

AX050, 70 and 80 Transceivers and AX-509 Ethernet Hub

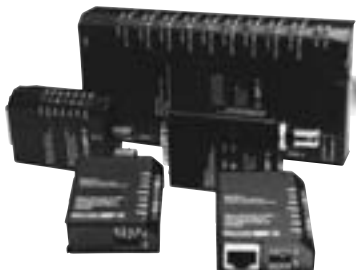

Realtime 10/100 Base-TX Ethernet Network Test Unit

The AX-110BT Realtime 10/100 Base-TX Ethernet Network Test Unit is a cost effective way to quickly determine a network's operating condition. Plug the unit's patch cord into the tester, then into any open RJ-45 jack in an office, cubicle or conference room. Immediately see if the jack is a live network node capable of either 100 Mb/s or 10 Mb/s. Next check patch cord continuity and polarity. Connect the downlink to a PC to check NIC card link, speed and full or half duplex capabilities. Connect the uplink to a hub or switch port to verify link and speed.

AX-110BT Realtime 10/100 Base-TX Ethernet Network Test Unit



Description	Belden Part Number
Network Connectivity Products	
Media Converter	
10Base-T/10Base2, RJ-45 to BNC	AX-200
10Base-T/10Base-FL, RJ-45 to ST-Compatible fiber connectors	AX-270
10Base2/10Base-FL, BNC to ST-Compatible fiber connectors	AX-280
100Base-TX/100Base-FX, SC-Compatible fiber connectors	AX-5270SC
100Base-TX/100Base-FX, ST-Compatible fiber connectors	AX-5270ST
Media Converter Rack	
Holds up to 12 converters and multi lead power supplies, 19 in. rack-mount ready	AX-1912-MCR
Power Supply, 4-lead 110v/12v, powers up to 4 converters	AX-270P4U
Power Supply, 8-lead 110v/12v, powers up to 8 converters	AX-270P8U
Transceivers and Ethernet Hubs	
UTP Transceiver, 10Base-T, AUI to RJ-45, side port	AX-50
UTP Transceiver, 10Base-T, AUI to RJ-45, rear port	AX-50R
Fiber Transceiver, 10Base-FL, AUI to ST-Compatible	AX-70
Thinnet Transceiver, 10Base2, AUI to BNC	AX-80
Ethernet Hub with 8 RJ-45 10Base-T ports and 1 AUI port	AX-509
Network Tester	
Realtime 10/100 Base-TX Ethernet Network Test Unit	AX-110BT

These products are in the process of being assessed for RoHS compliance. Please check our Web Site for the most current RoHS status.

Cable Selection Guide

Introduction

The Belden line of Optical Fiber Cables represents a new selection of the best optical fiber cable products offered by the consolidated resources of the Belden organization. The unmatched resources of Belden have now generated a complete line of indoor and outdoor cable products in tight buffered and loose tube constructions. This offering now expands the available applications for Belden optical fiber cable.

Customer Service

Most of our optical fiber cables are available from stock. Many of these are available off-the-shelf from distributors. If you have a new or unusual application, or you cannot find a optical fiber cable in this catalog section that meets your technical requirements, contact Technical Support at 1-800-BELDEN-1 for additional information.

Cable Selection Guide

Optical Fiber Selection

Type	Grade	Fiber Size (μ)	Standards Compliance	Link Length (m)	Data Rate (Gb)
Multimode	6	50/125	exceeds TIA/EIA-568-B.3-1 ISO 11801 OM3	500	10
	5	50/125	TIA/EIA-568-B.3-1 ISO 11801 OM3	300	10
	4	50/125	TIA/EIA-568-B.3	600	1
	3	62.5/125	TIA/EIA-568-B.3	1,000	1
	2	62.5/125	TIA/EIA-568-B.3	550	1
1 [▲]	62.5/125	FDDI grade [†]	—	—	—
Single-mode	—	—	ITU G.652.c/d ^{††}	—	—

▲ Grade 1 fibers are available upon request.

† Used in most current cable plants, but not recommended for future installations, except as patch cordage

†† Low water peak fiber with advantages for CWDM applications

Color Code Charts

Jacket Color Chart

Cable Type	Jacket Color
Loose Tube & Outside Plant Cables	Black
Industrial Tray Cables	Orange
Tight Buffered Cables	
Grades 2,3,4	Orange
Grades 5,6	Aqua
Single-mode	Yellow

Nonstandard jacket colors are available upon request.

Fiber Sub-unit Color Code Chart*

Fiber/Tube No.	Color	Fiber/Tube No.	Color
1	Blue	7	Red
2	Orange	8	Black
3	Green	9	Yellow
4	Brown	10	Violet
5	Slate	11	Rose
6	White	12	Aqua

*Per EIA/TIA 598-A

Optical Specifications

Grade:	2	3	4	5	6	Single-mode Enhanced ⁶
Glass Type:	62.5/125μ	62.5/125μ	50/125μ	50/125μ	50/125μ	
Operating Wavelength (nm)	850/1300	850/1300	850/1300	850/1300	850/1300	1310/1550
Min. OFL ¹ Bandwidth (MHz-km)	200/500	200/500	500/500	1500/500	3000/500	—
Min. Laser ² Bandwidth (MHz-km)	220/500	385/500	510/500	2000/500	4000/500	—
Max. Attenuation Loose Tube (dB/km)	3.25/1.0	3.25/1.0	3.0/1.0	3.0/1.0	3.0/1.0	0.40/0.30
Max. Attenuation Tight Buffered ³ (dB/km)	3.50/1.25	3.50/1.25	3.50/1.25	3.50/1.25	3.50/1.25	0.80/0.50
100 Mb Fast Ethernet Min. Link Length (meters S/L ⁴)	300/2000	300/2000	300/2000	300/2000	300/2000	—/5000
1 Gb Ethernet Min. Link Length (meters S/L ⁴)	300/550	500/1000	600/600	1000 ⁵ /600	1000 ⁵ /600	—/5000
10 Gb Ethernet Min. Link Length (meters S/L ⁴)	35/300	35/300	85/300	300/300	500/300	—/10,000

¹ OFL = Overfilled Launch

² Effective Modal Bandwidth, determined by RML or DMD performance specifications

³ Max. Attenuation for Tight Buffered, Ribbon, Micro-Loose Tube and Loose Tube Plenum Cables

⁴ S/L = Short wavelength (850 nm) / Long wavelength (1310 nm)

⁵ >2000 meters for engineered links

⁶ Low water peak Single-Mode suitable for CWDM use complies with ITU G.652.c/d



Interconnect Cable — Simplex and Duplex

Tight Buffer — Riser & Plenum Rated

Applications

- Patch panels
- Workstation equipment connections
- Horizontal distribution in open office environments

Product Description

Interconnect Cables are designed for low fiber-count premises environments. They are small and very flexible, making them ideal for confined spaces. Their aesthetic appearance makes these cables suitable for use in open office environments. Available in 1 or 2 fibers. One sub-unit is marked to permit easy identification of transmit and receive fibers. Length markings to facilitate installation.

Jacket Material	PVC
Tight Buffer	PVC
Strength Member	Aramid Yarn
Color Code (Tight Buffer)	Per EIA/TIA 598-A, see page 10.2
Jacket Color	
Single-mode	Yellow
62.5/125 μm	Orange
50/125 μm / 1 Gbe	Orange
50/125 μm / 10 Gbe	Aqua

Ratings

Riser	
UL Type	OFNR
cUL Type	OFN FT4
Flame Resistance	UL 1666
Plenum	
UL Type	OFNP
cUL Type	OFN FT6
Flame Resistance	NFPA 262

Specifications

Temperature Range	
Storage	-40 to +70°C
Operating	-20 to +70°C
Crush Resistance (EIA-455-41)	200 N/cm
Impact Resistance (EIA-455-25)	20 Impacts @ 1.0 N-m
Cyclic Flexing (EIA-455-104)	2000 cycles, min.
Min. Bend Radius	
Installation	15 x OD
Long Term	10 x OD
Optical Specifications	See page 10.2

Fiber Bundle Detail

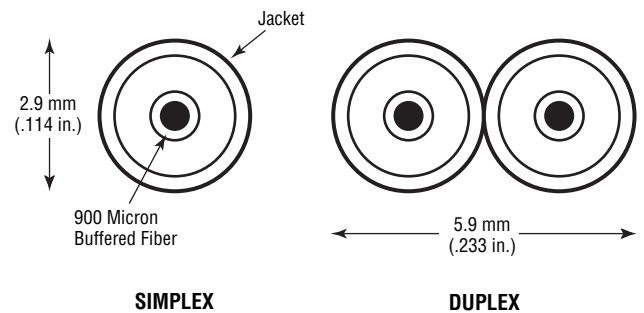

No. of Fibers	Belden Part Number				Outside Diameter		Weight		Max. Install Load	
	62.5 / 125μm Std. / 1 Gbe	50 / 125μm Std. / 1 Gbe	50 / 125μm 10 Gbe – 300M	Single-mode Enhanced	Inch	mm	Lbs./'1000'	kg/km	Lbs.	N
Interconnect Cable Series										
Riser (NEC/CEC OFNR/OFN FT4)										
1	M97112	M9A001	M9C001	M9W001	0.114	2.9	6	9	90	400
2	M96915	M9A002	M9C002	M9W002	0.11 x 0.23	2.9 x 5.9	12	18	180	801
Plenum (NEC/CEC OFNP/OFN FT6)										
1	M98086	M9A003	M9C003	M9W003	0.114	2.9	6	9	90	400
2	M96919	M9A004	M9C004	M9W004	0.11 x 0.23	2.9 x 5.9	13	19	180	801

Distribution Cable

Tight Buffer — Indoor Riser, Plenum & LSZH Rated

Applications

- Low to high fiber count requirements
- In-building backbone
- Fiber-to-the-desk applications
- Computer room

Product Description

Flexible thermoplastic jacket provides excellent handling characteristics. Fibers and cable sub-units are color coded for easy identification. Length markings in meters for easy determination of cable length. Full dielectric construction, no grounding required. For Riser offering, MSHA approved cables are available.

Jacket Material	
Riser & Non-unitized Plenum	PVC
Unitized Plenum	PVDF
Low Smoke Zero Halogen	LSZH
Tight Buffer	
Riser & Plenum	PVC
Low Smoke Zero Halogen	LSZH
Strength Member Aramid Yarn	
Color Code (Tight Buffer) Per EIA/TIA 598-A, see page 10.2	
Jacket Color	
Single-mode	Yellow
62.5/125 μm	Orange (Green for LSZH only)
50/125 μm / 1 Gbe	Orange
50/125 μm / 10 Gbe	Aqua

Ratings

Riser	
UL Type	OFNR
cUL Type	OFN FT4
Flame Resistance	UL 1666
Plenum	
UL Type	OFNP
cUL Type	OFN FT6
Flame Resistance	NFPA 262
Low Smoke Zero Halogen	
UL Type	OFNR
cUL Type	OFN FT4
Flame Resistance	UL 1666

Specifications

Temperature Range	
Storage	-40 to +80°C
Operating	-20 to +70°C
Crush Resistance (EIA-455-41)	2000 N/cm
Impact Resistance (EIA-455-25)	2000 Impacts @ 1.6 N-m
Cyclic Flexing (EIA-455-104)	2000 cycles, min.
Min. Bend Radius	
Installation	15 x OD
Long Term	10 x OD
Optical Specifications	See page 10.2

Fiber Bundle Detail

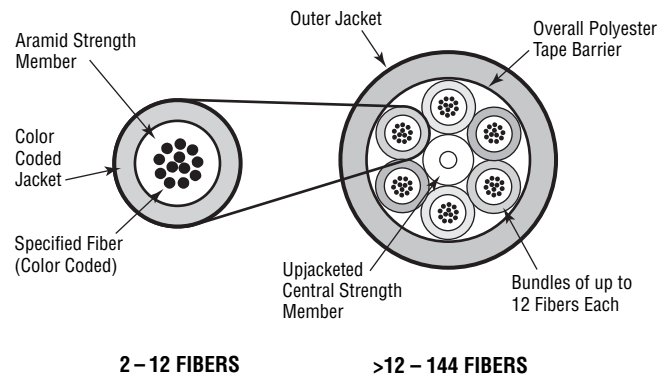

Distribution Cable

Tight Buffer — Indoor Riser, Plenum & LSZH Rated *(continued)*

No. of Fibers	Belden Part Number				Outside Diameter		Weight		Max. Install Load	
	62.5 / 125µm Std. / 1 Gbe	50 / 125µm Std. / 1 Gbe	50 / 125µm 10 Gbe – 300M	Single-mode Enhanced	Inch	mm	Lbs./1000'	kg/km	Lbs.	N

Distribution Cable Series

Riser (NEC/CEC OFNR/OFN FT4)

2	M9B037	M9A037	M9C037	M9W037	0.184	4.67	13	19	180	801
4	M9B038	M9A038	M9C038	M9W038	0.200	5.08	16	24	195	867
6	M9B039	M9A039	M9C039	M9W039	0.220	5.59	19	28	270	1201
8	M9B040	M9A040	M9C040	M9W040	0.235	5.97	22	33	270	1201
12	M9B042	M9A042	M9C042	M9W042	0.255	6.48	27	40	300	1334
24	M9B601*	M9A601*	M9C601*	M9W601*	0.325	8.26	42	63	390	1735
24	M9B602	M9A602	M9C602	M9W602	0.496	12.60	83	124	960	4270
36	M9B604	M9A604	M9C604	M9W604	0.644	16.36	137	204	1440	6405
48	M9B606	M9A606	M9C606	M9W606	0.627	15.93	131	195	945	4203
72	M9B609	M9A609	M9C609	M9W609	0.750	19.10	195	290	1350	6005
96	M9B622	M9A622	M9C622	M9W622	0.895	22.70	290	432	1983	8820
144	M9B619	M9A619	M9C619	M9W619	0.964	24.49	314	467	2745	12210

Composite Riser Cables

6xSM/12x62.5	M96992
12xSM/12x62.5	M96963
6xSM/12x50	M96909
12xSM/12x50	M96908

Plenum (NEC/CEC OFNP/OFN FT6)

2	M9B043	M9A043	M9C043	M9W043	0.184	4.67	14	21	180	801
4	M9B044	M9A044	M9C044	M9W044	0.174	4.42	13	19	195	867
6	M9B045	M9A045	M9C045	M9W045	0.190	4.83	16	24	270	1201
8	M9B046	M9A046	M9C046	M9W046	0.222	5.64	19	28	270	1201
12	M9B048	M9A048	M9C048	M9W048	0.225	5.72	22	33	300	1334
24	M9B611*	M9A611*	M9C611*	M9W611*	0.330	8.38	40	60	390	1735
24	M9B612	M9A612	M9C612	M9W612	0.493	12.52	89	132	1263	5618
36	M9B614	M9A614	M9C614	M9W614	0.594	15.09	134	199	1913	8509
48	M9B616	M9A616	M9C616	M9W616	0.599	15.21	131	195	1245	5538
72	M9B620	M9A620	M9C620	M9W620	0.754	19.15	197	293	2093	9310
96	M9B623	M9A623	M9C623	M9W623	0.904	22.96	268	399	2160	9608
144	M9B621	M9A621	M9C621	M9W621	1.047	26.59	365	543	3645	16213

Composite Plenum Cables

6xSM/6x62.5	M97174
6xSM/12x62.5	M97041
12xSM/12x62.5	M97219
6xSM/6x50	M97412
6xSM/12x50	M97411
12xSM/12x50	M96780

LSZH (NEC/CEC OFNR/OFN FT4)

2	M9B100	M9A100	M9C100	M9W100	0.184	4.67	15	22	180	800
4	M9B101	M9A101	M9C101	M9W101	0.200	5.08	17	25	195	867
6	M9B102	M9A102	M9C102	M9W102	0.220	5.59	21	31	270	1201
8	M9B103	M9A103	M9C103	M9W103	0.235	5.97	24	36	270	1201
12	M9B104	M9A104	M9C104	M9W104	0.255	6.48	29	43	300	1334
16	M9B105	M9A105	M9C105	M9W105	0.347	8.80	43	63	315	1400
24	M9B107	M9A107	M9C107	M9W107	0.386	9.80	54	79	450	2000
36	M9B111	M9A111	M9C111	M9W111	0.798	20.00	214	313	1619	7200
48	M9B112	M9A112	M9C112	M9W112	0.835	21.20	237	347	1619	7200
72	M9B114	M9A114	M9C114	M9W114	0.883	22.40	270	395	1619	7200
96	M9B116	M9A116	M9C116	M9W116	0.973	24.70	364	532	1619	7200
144	M9B120	M9A120	M9C120	M9W120	1.087	27.60	384	561	1619	7200

Construction for LSZH cables differs from the drawing. Alternative fiber counts are available.

*Single jacket design.



Breakout Style Cable

Tight Buffer — Indoor Riser, Plenum & LSZH Rated

Applications

- Low to medium fiber count requirements
- In-building backbone or horizontal deployment
- Office wiring
- Factory floor automation and harsh environment installations

Product Description

Full dielectric construction, no grounding required. Available with 2 to 36 fibers. Fiber subunits are color coded for easy identification. Length markings in meters for easy determination of cable length. For Riser offering, MSHA approved cables are available.

Outer Jacket Material	
Riser & Plenum	PVC
Plenum	PVDF
Low Smoke Zero Halogen	LSZH
Sub-unit Jacket Material	
Riser & Plenum	PVC
Low Smoke Zero Halogen	LSZH
Tight Buffer	
Riser & Plenum	PVC
Low Smoke Zero Halogen	LSZH
Strength Member	
	Aramid Yarn
Color Code (Tight Buffer)	
	Per EIA/TIA 598-A, see page 10.2
Jacket Color	
Single-mode	Yellow
62.5/125 μm	Orange (Green for LSZH only)
50/125 μm / 1 Gbe	Orange
50/125 μm / 10 Gbe	Aqua

Ratings

Riser	
UL Type	OFNR
cUL Type	OFN FT4
Flame Resistance	UL 1666
Plenum	
UL Type	OFNP
cUL Type	OFN FT6
Flame Resistance	NFPA 262
Low Smoke Zero Halogen	
UL Type	OFNR
cUL Type	OFN FT4
Flame Resistance	UL 1666

Specifications

Temperature Range	
Storage	-40 to +80°C
Operating	-20 to +70°C
Crush Resistance (EIA-455-41)	2000 N/cm
Impact Resistance (EIA-455-25)	2000 Impacts @ 1.6 N-m
Cyclic Flexing (EIA-455-104)	2000 cycles, min.
Min. Bend Radius	
Installation	15 x OD
Long Term	10 x OD
Optical Specifications	See page 10.2

Fiber Bundle Detail

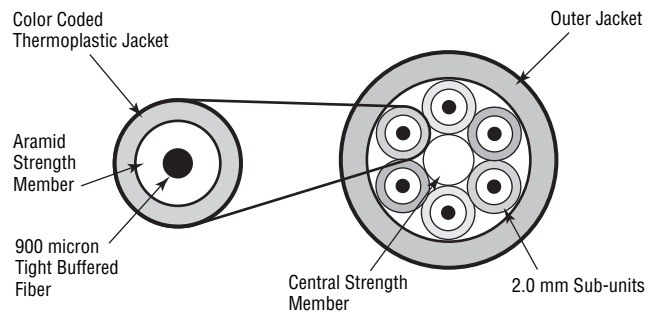

Breakout Style Cable

Tight Buffer — Indoor Riser, Plenum & LSZH Rated *(continued)*

No. of Fibers	Belden Part Number				Outside Diameter		Weight		Max. Install Load	
	62.5 / 125µm Std. / 1 Gbe	50 / 125µm Std. / 1 Gbe	50 / 125µm 10 Gbe – 300M	Single-mode Enhanced	Inch	mm	Lbs./1000'	kg/km	Lbs.	N
Breakout Cable Series										
Riser (NEC/CEC OFNR/OFN FT4)										
2	M9B005	M9A005	M9C005	M9W005	0.260	6.60	24	36	180	801
4	M9B006	M9A006	M9C006	M9W006	0.321	8.15	35	52	345	1535
6	M9B007	M9A007	M9C007	M9W007	0.358	9.09	54	80	543	2415
8	M9B008	M9A008	M9C008	M9W008	0.405	10.29	69	103	600	2700
10	M9B009	M9A009	M9C009	M9W009	0.455	11.56	86	128	600	2700
12	M9B010	M9A010	M9C010	M9W010	0.514	13.06	110	164	600	2700
18	M9B011	M9A011	M9C011	M9W011	0.520	13.21	104	155	600	2700
24	M9B012	M9A012	M9C012	M9W012	0.590	14.99	135	201	600	2700
36	M9B083	M9A083	M9C083	M9W083	0.680	17.27	168	250	600	2700
Plenum (NEC/CEC OFNP/OFN FT6)										
2	M9B013	M9A013	M9C013	M9W013	0.230	5.84	20	30	180	801
4	M9B014	M9A014	M9C014	M9W014	0.263	6.68	30	45	345	1535
6	M9B015	M9A015	M9C015	M9W015	0.309	7.85	41	61	465	2068
8	M9B016	M9A016	M9C016	M9W016	0.336	8.53	55	82	600	2700
10	M9B017	M9A017	M9C017	M9W017	0.385	9.78	73	109	600	2700
12	M9B018	M9A018	M9C018	M9W018	0.391	9.93	65	97	600	2700
18	M9B019	M9A019	M9C019	M9W019	0.456	11.58	89	132	600	2700
24	M9B020	M9A020	M9C020	M9W020	0.544	13.82	117	174	600	2700
36	M9B082	M9A082	M9C082	M9W082	0.612	15.54	154	229	600	2700
LSZH (NEC/CEC OFNR/OFN FT4)										
2	M9B130	M9A130	M9C130	M9W130	0.290	7.37	39	57	270	1200
4	M9B131	M9A131	M9C131	M9W131	0.351	8.92	38	55	285	1268
6	M9B132	M9A132	M9C132	M9W132	0.358	9.09	52	76	543	2415
8	M9B133	M9A133	M9C133	M9W133	0.405	10.29	67	98	600	2700
10	M9B134	M9A134	M9C134	M9W134	0.455	11.56	110	162	600	2700
12	M9B135	M9A135	M9C135	M9W135	0.514	13.06	110	161	600	2700
18	M9B136	M9A136	M9C136	M9W136	0.520	13.21	103	151	600	2700
24	M9B137	M9A137	M9C137	M9W137	0.590	14.99	138	202	600	2700
36	M9B138	M9A138	M9C138	M9W138	0.680	17.27	171	250	600	2700

2.5 mm Breakout Cables are also available.

Industrial Armored Cable

Tight Buffer — Riser & Plenum Rated

Applications

- Industrial environments
- Rugged installations
- Manufacturing plants
- Mining operations
- Telecommunications and data trunk
- Inter- and intra-building installations

Product Description

Heavy duty construction with interlocking aluminum armor (steel available on request) provides excellent mechanical protection from cutting or crushing and eliminates need for innerduct. Rodent resistant. Also available for outside plant. Loose tube design available on request.

Jacket Material	Riser & Plenum	PVC
Buffer Tube		PVC
Strength Member		Aramid Yarn
Central Strength Member		E-Glass
Armor		Aluminum
Color Code (Buffer)		Per EIA/TIA 598-A, see page 10.2
Jacket Color	Single-mode 62.5/125 μm 50/125 μm / 1 Gbe 50/125 μm / 10 Gbe	Yellow Orange Orange Aqua

Ratings

Riser	UL Type	OFRC
	cUL Type	OFC FT4
	Flame Resistance	UL 1666
Plenum	UL Type	OFCP
	cUL Type	OFC FT6
	Flame Resistance	NFPA 262

Specifications

Temperature Range	Storage	-40 to +70°C
	Operating	-20 to +70°C
Crush Resistance (EIA-455-41)		2000 N/cm
Impact Resistance (EIA-455-25)		2000 Impacts @ 3.0 N-m
Min. Bend Radius	Installation	20 x OD
	Long Term	15 x OD
Optical Specifications		See page 10.2

Fiber Bundle Detail

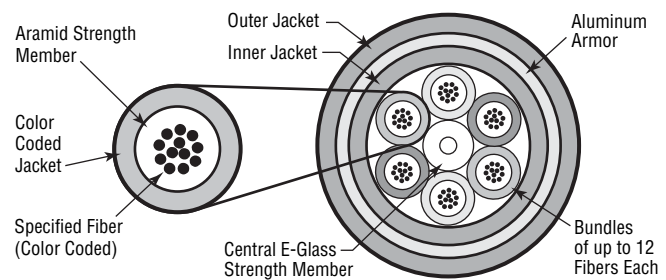

No. of Fibers	Belden Part Number				Outside Diameter		Weight		Max. Install Load	
	62.5 / 125μm Std. / 1 Gbe	50 / 125μm Std. / 1 Gbe	50 / 125μm 10 Gbe – 300M	Single-mode Enhanced	Inch	mm	Lbs./'1000'	kg/km	Lbs.	N

Industrial Armored Series

Riser (NEC/CEC OFCR/OFC FT4)										
6	M9B230	M9A230	M9C230	M9W230	0.570	14.50	126	188	270	1201
12	M9B231	M9A231	M9C231	M9W231	0.620	15.70	149	222	300	1334
24	M9B232*	M9A232*	M9C232*	M9W232*	0.670	17.00	179	266	390	1735
24	M9B233	M9A233	M9C233	M9W233	0.845	21.46	263	391	600	2700
36	M9B234	M9A234	M9C234	M9W234	0.970	24.64	368	548	600	2700
48	M9B235	M9A235	M9C235	M9W235	0.970	24.64	368	548	600	2700
72	M9B236	M9A236	M9C236	M9W236	1.095	27.82	481	716	600	2700
96	M9B237	M9A237	M9C237	M9W237	1.245	31.62	625	930	600	2700
144	M9B238	M9A238	M9C238	M9W238	1.320	33.55	675	1005	600	2700
Plenum (NEC/CEC OFCP/OFC FT6)										
6	M9B240	M9A240	M9C240	M9W240	0.471	12.00	87	129	270	1201
12	M9B241	M9A241	M9C241	M9W241	0.506	12.90	103	153	300	1334
24	M9B242*	M9A242*	M9C242*	M9W242*	0.631	16.00	151	225	390	1735
24	M9B243	M9A243	M9C243	M9W243	0.781	19.84	289	430	600	2700
36	M9B244	M9A244	M9C244	M9W244	0.881	22.38	309	460	600	2700
48	M9B245	M9A245	M9C245	M9W245	0.906	23.01	320	476	600	2700
72	M9B246	M9A246	M9C246	M9W246	1.056	26.82	451	671	600	2700
96	M9B247	M9A247	M9C247	M9W247	1.256	31.90	608	905	600	2700
144	M9B248	M9A248	M9C248	M9W248	1.331	33.81	687	1022	600	2700

*Single jacket design.

All optical fiber products can be supplied in compliance with RoHS regulations.



Tactical Cable

Tight Buffer — Outdoor

Applications

- ENG vehicles
- Outdoor news, sporting or other events
- Digital camera transmission
- Military communications
- Re-deployable communications

Product Description

Small and lightweight with a rugged jacket, Tactical Cable provides a durable design for repeated deployment and retrieval cycles and a superior level of crush resistance. Designed to military standards. 50/125 micron fiber available on request.

Jacket Material	UV-resistant PU
Buffer	Polyester
Strength Member	Aramid Yarn
Color Code (Jacket & Fibers)	Per EIA/TIA 598-A, see page 10.2

Specifications

Temperature Range	
Storage	-70 to +85°C
Operating	-55 to +85°C
Crush Resistance (EIA-455-41)	440 N/cm
Impact Resistance (EIA-455-25)	200 Impacts @ 2.2 N-m
Cyclic Flexing (EIA-455-104)	2000 cycles, min.
Min. Bend Radius	
Installation	15 x OD
Long Term	8 x OD
Optical Specifications	See page 10.2

Fiber Bundle Detail

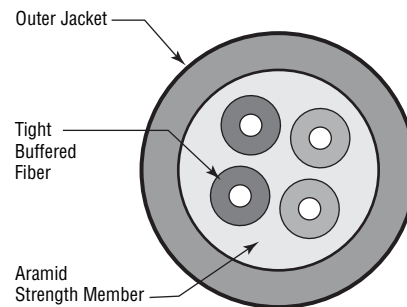

No. of Fibers	Belden Part Number		Outside Diameter		Weight		Max. Install Load	
	62.5 / 125µm Std. / 1 Gbe	Single-mode Enhanced	Inch	mm	Lbs./1000'	kg/km	Lbs.	N

Tactical Series

Outdoor								
2	M96571	M96566	0.217	5.5	19	28	330	1468
4	M96551	M96639	0.225	5.7	21	31	330	1468
6	M96572	M96567	0.236	6.0	23	34	330	1468
8	M96573	M96568	0.250	6.3	26	39	330	1468
10	M96574	M96569	0.265	6.7	28	42	330	1468
12	M96575	M96570	0.280	7.1	31	46	330	1468

Please contact the Technical Support Group for proper connectivity integration and installation guidance.

Ribbon Cable

Riser and Plenum Rated

Applications

- Inter-equipment connections
- NEBS applications

Product Description

Small size is ideal for connections in tight spaces. Color coded fibers. Suitable for use with standard ribbon connectors. Flexible, with half-inch minimum bend radius. Tight center-to-center tolerances. Optional identification printing available.

Jacket Material	PVC
Strength Member	Aramid Yarn
Color Code (Jacket & Fibers)	Per EIA/TIA 598-A, see page 10.2
Jacket Color	
Single-mode	Yellow
62.5/125µm	Orange
50/125 µm / 1 Gbe	Orange
50/125 µm / 10 Gbe	Aqua

Ratings

Riser	
UL Type	OFNR
cUL Type	OFN FT4
Flame Resistance	UL 1666
Plenum	
UL Type	OFNP
cUL Type	OFN FT6
Flame Resistance	NFPA 262

Specifications

Temperature Range	
Storage	-40 to +80°C
Operating	-20 to +70°C
Crush Resistance (EIA-455-41)	2000 N/cm
Impact Resistance (EIA-455-25)	2000 Impacts @ 1.6 N-m
Cyclic Flexing (EIA-455-104)	2000 cycles, min.
Min. Bend Radius	
Installation	15 x OD
Long Term	10 x OD
Optical Specifications	See page 10.2

Fiber Bundle Detail

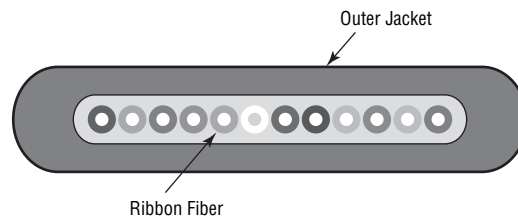

No. of Fibers	Belden Part Number				Outside Diameter		Weight		Max. Install Load	
	62.5 / 125µm Std. / 1 Gbe	50 / 125µm Std. / 1 Gbe	50 / 125µm 10 Gbe – 300M	Single-mode Enhanced	Inch	mm	Lbs./1000'	kg/km	Lbs.	N

Ribbon Series

Riser (NEC/CEC OFNR/OFN FT4)										
2	M9B630	M9A630	M9C630	M9W630	0.114	2.9	5	7	100	444
4	M9B631	M9A631	M9C631	M9W631	0.78 x 0.115	2.0 x 2.9	4	6	100	444
6	M9B632	M9A632	M9C632	M9W632	0.78 x 0.137	2.0 x 3.5	6	9	100	444
8	M9B633	M9A633	M9C633	M9W633	0.78 x 0.158	2.0 x 4.0	6	9	100	444
12	M9B634	M9A634	M9C634	M9W634	0.78 x 0.180	2.0 x 4.6	7	10	100	444
Plenum (NEC/CEC OFNP/OFN FT6)										
2	M9B640	M9A640	M9C640	M9W640	0.114	2.9	5	7	100	444
4	M9B641	M9A641	M9C641	M9W641	0.78 x 0.115	2.0 x 2.9	4	6	100	444
6	M9B642	M9A642	M9C642	M9W642	0.78 x 0.137	2.0 x 3.5	6	9	100	444
8	M9B643	M9A643	M9C643	M9W643	0.78 x 0.158	2.0 x 4.0	6	9	100	444
12	M9B644	M9A644	M9C644	M9W644	0.78 x 0.180	2.0 x 4.6	7	10	100	444

Fiber Ribbon Cable is to be sold as bulk cable and has not been qualified for field connectorization.

Single Jacket, All Dielectric Cable

Loose Tube — Outdoor, and Indoor/Outdoor Riser Rated

Applications

- Medium to high fiber count requirements
- Inter-building duct installations
- Lashed aerial
- Indoor/outdoor
- Industrial outside plant

Product Description

Gel-filled buffer tube prevents water migration. All-dielectric strength member. Available as Riser rated cable, thereby eliminating the need for service entrance splicing to in-building cable. Full dielectric construction, no grounding required. Available with up to 216 fibers. Length markings in meters for easy determination of cable length.

Jacket Material	
Outdoor	PE
Riser	PVC
Buffer Tube	PBT
Strength Member	Aramid Yarn
Central Strength Member	E-Glass
Color Code (Buffer)	Per EIA/TIA 598-A, see page 10.2
Jacket Color	Black

Ratings

Riser	
UL Type	OFNR
cUL Type	OFN FT4
Flame Resistance	UL 1666

Specifications

Temperature Range (Outdoor Series)	
Storage	-50 to +80°C
Operating	-40 to +70°C
Temperature Range (Riser Series)	
Storage	-40 to +80°C
Operating	-40 to +70°C
Crush Resistance (EIA-455-41)	2000 N/cm
Impact Resistance (EIA-455-25)	2000 Impacts @ 1.6 N-m
Min. Bend Radius	
Installation	20 x OD
Long Term	15 x OD
Optical Specifications	See page 10.2

Fiber Bundle Detail

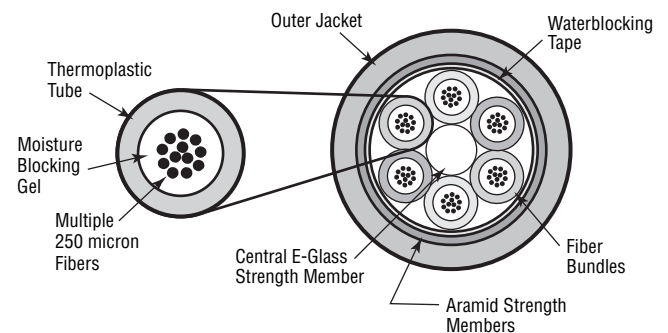

No. of Fibers	Fibers Per Tube	Belden Part Number				Outside Diameter		Weight		Max. Install Load	
		62.5 / 125µm Std. / 1 Gbe	50 / 125µm Std. / 1 Gbe	50 / 125µm 10 Gbe – 300M	Single-mode Enhanced	Inch	mm	Lbs./1000'	kg/km	Lbs.	N

Loose Tube Series

Outdoor											
6	6	M9B510T	M9A510T	M9C510T	M9W510T	0.38	9.65	44	65	600	2700
12	6	M9B511T	M9A511T	M9C511T	M9W511T	0.38	9.65	44	65	600	2700
24	6	M9B500T	M9A500T	M9C500T	M9W500T	0.38	9.65	45	67	600	2700
36	6	M9B502T	M9A502T	M9C502T	M9W502T	0.38	9.65	47	70	600	2700
48	12	M9B505T	M9A505T	M9C505T	M9W505T	0.48	12.19	70	104	600	2700
72	12	M9B507T	M9A507T	M9C507T	M9W507T	0.48	12.19	70	104	600	2700
96	12	M9B513T	M9A513T	M9C513T	M9W513T	0.55	13.89	93	138	600	2700
144	12	M9B509T	M9A509T	M9C509T	M9W509T	0.70	17.78	149	222	600	2700
216	12	M9B520T	M9A520T	M9C520T	M9W520T	0.72	18.16	148	220	600	2700
Riser (NEC/CEC OFNR/OFN FT4)											
6	6	M9B810	M9A810	M9C810	M9W810	0.38	9.65	63	94	600	2700
12	6	M9B811	M9A811	M9C811	M9W811	0.38	9.65	62	92	600	2700
24	6	M9B812	M9A812	M9C812	M9W812	0.38	9.65	61	91	600	2700
36	6	M9B813	M9A813	M9C813	M9W813	0.38	9.65	60	89	600	2700
48	12	M9B814	M9A814	M9C814	M9W814	0.48	12.19	89	132	600	2700
72	12	M9B815	M9A815	M9C815	M9W815	0.48	12.19	87	129	600	2700
96	12	M9B816	M9A816	M9C816	M9W816	0.55	13.89	114	170	600	2700
144	12	M9B817	M9A817	M9C817	M9W817	0.70	17.78	187	278	600	2700

Alternative fiber counts are available.



Single Jacket, All Dielectric Cable

Loose Tube — Indoor/Outdoor Plenum Rated

Applications

- Medium to high fiber count requirements
- Inter-building duct installations
- Lashed aerial
- Indoor/outdoor
- Campus backbones
- Data Centers
- High Density Cable Trays

Product Description

Dry waterblocking technology used within tubes and under jacket. Available as Plenum rated cable, thereby eliminating the need for service entrance splicing to in-building cable. Small diameter and bend radius facilitate installation in tight spaces. Full dielectric construction, no grounding required. Available with up to 144 fibers. Fibers grouped into sets of 12 for maximum density. Length markings in meters for easy determination of cable length.

Jacket Material	PVC Non-unitized PVDF Unitized
Buffer Tube	PVC
Strength Member	E-Glass and Aramid Yarn
Central Strength Member	Upjacketed
Color Code (Buffer)	Per EIA/TIA 598-A, see page 10.2
Jacket Color	Black

Ratings

Plenum	OFNP
UL Type	OFN FT6
cUL Type	NFPA 262
Flame Resistance	

Specifications

Temperature Range	
Storage	-40 to +80°C
Operating	-40 to +70°C
Installation	0 to +60°C
Crush Resistance (EIA-455-41)	2000 N/cm
Impact Resistance (EIA-455-25)	2000 Impacts @ 1.6 N-m
Cyclic Flexing (EIA-455-104)	2000 cycles, min.
Min. Bend Radius	
Installation	20 x OD
Long Term	15 x OD
Optical Specifications	See page 10.2

Fiber Bundle Detail

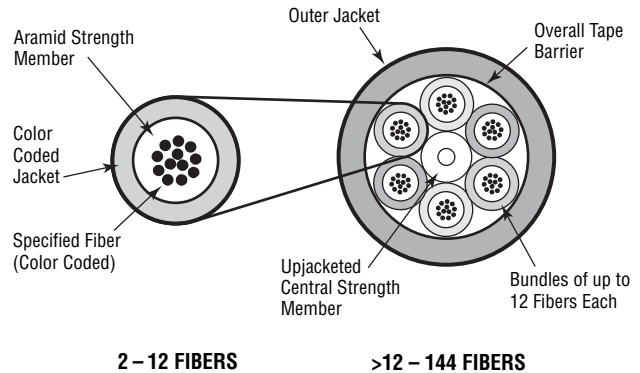

No. of Fibers	Fibers Per Tube	Belden Part Number				Outside Diameter		Weight		Max. Install Load	
		62.5 / 125µm Std. / 1 Gbe	50 / 125µm Std. / 1 Gbe	50 / 125µm 10 Gbe - 300M	Single-mode Enhanced	Inch	mm	Lbs./1000'	kg/km	Lbs.	N

Loose Tube Series

Plenum (NEC/CEC OFNP/OFN FT6)											
6	6	M9B202	M9A202	M9C202	M9W202	0.265	6.70	33	49	320	1423
12	12	M9B204	M9A204	M9C204	M9W204	0.265	6.70	33	49	320	1423
24	12	M9B205	M9A205	M9C205	M9W205	0.359	9.12	47	70	405	1801
36	12	M9B206	M9A206	M9C206	M9W206	0.359	9.12	47	70	405	1801
48	12	M9B207	M9A207	M9C207	M9W207	0.359	9.12	48	71	405	1801
72	12	M9B209	M9A209	M9C209	M9W209	0.429	10.90	71	106	585	2602
96	12	M9B211	M9A211	M9C211	M9W211	0.501	12.73	105	156	903	4017
144	12	M9B215	M9A215	M9C215	M9W215	0.665	16.89	189	281	1263	5618

Alternative fiber counts and hybrid constructions are available.

Double Jacket, Armored Cable

Loose Tube – Outdoor, and Indoor/Outdoor Riser Rated

Applications

- Direct burial
- Low to high fiber count requirements
- Inter-building duct installations
- Indoor/outdoor
- Industrial outside plant

Product Description

Gel-filled buffer tube prevents water migration. Available as Riser rated cable, thereby eliminating the need for service entrance splicing to in-building cable. Rodent resistant. Available in sizes up to 216 fibers. Length markings in meters for easy determination of cable length.

Jacket Material	
Outdoor	PE
Riser	PVC
Buffer Tube	
Outdoor	PBT
Riser	PVC
Strength Member	
	Aramid Yarn
Central Strength Member	
	E-Glass
Armor	
	Corrugated Steel Tape
Color Code (Buffer)	
	Per EIA/TIA 598-A, see page 10.2
Jacket Color	
	Black

Ratings

Riser	
UL Type	OFCR
cUL Type	OFC FT4
Flame Resistance	UL 1666

Specifications

Temperature Range (Outdoor)	
Storage	-50 to +80°C
Operating	-40 to +70°C
Temperature Range (Riser)	
Storage	-40 to +80°C
Operating	-40 to +70°C
Crush Resistance (EIA-455-41)	2000 N/cm
Impact Resistance (EIA-455-25)	2000 Impacts @ 1.6 N-m
Min. Bend Radius	
Installation	20 x OD
Long Term	15 x OD
Optical Specifications	See page 10.2

Fiber Bundle Detail

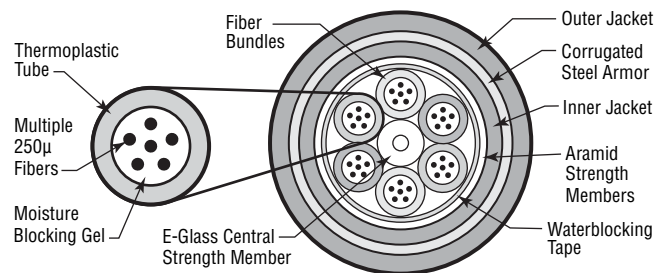

No. of Fibers	Fibers Per Tube	Belden Part Number				Outside Diameter		Weight		Max. Install Load	
		62.5 / 125µm Std. / 1 Gbe	50 / 125µm Std. / 1 Gbe	50 / 125µm 10 Gbe – 300M	Single-mode Enhanced	Inch	mm	Lbs./1000'	kg/km	Lbs.	N

Loose Tube Series — Armored

Outdoor											
6	6	M9B381T	M9A381T	M9C381T	M9W381T	0.53	13.46	101	150	600	2700
12	6	M9B382T	M9A382T	M9C382T	M9W382T	0.53	13.46	102	152	600	2700
24	6	M9B384T	M9A384T	M9C384T	M9W384T	0.53	13.46	103	153	600	2700
36	6	M9B386T	M9A386T	M9C386T	M9W386T	0.53	13.46	103	153	600	2700
48	12	M9B389T	M9A389T	M9C389T	M9W389T	0.65	16.51	144	214	600	2700
72	12	M9B391T	M9A391T	M9C391T	M9W391T	0.65	16.51	142	211	600	2700
96	12	M9B398T	M9A398T	M9C398T	M9W398T	0.69	17.53	168	250	600	2700
144	12	M9B393T	M9A393T	M9C393T	M9W393T	0.87	22.10	241	359	600	2700
216	12	M9B400T	M9A400T	M9C400T	M9W400T	0.87	22.10	241	359	600	2700
Riser (NEC/CEC OFCR/OFC FT4)											
6	6	M9B890	M9A890	M9C890	M9W890	0.54	13.72	138	205	600	2700
12	6	M9B891	M9A891	M9C891	M9W891	0.54	13.72	137	204	600	2700
24	6	M9B892	M9A892	M9C892	M9W892	0.54	13.72	136	202	600	2700
36	6	M9B893	M9A893	M9C893	M9W893	0.54	13.72	135	201	600	2700
48	12	M9B894	M9A894	M9C894	M9W894	0.66	16.76	176	262	600	2700
72	12	M9B895	M9A895	M9C895	M9W895	0.66	16.76	172	256	600	2700
96	12	M9B896	M9A896	M9C896	M9W896	0.70	17.78	206	307	600	2700
144	12	M9B897	M9A897	M9C897	M9W897	0.88	22.35	302	449	600	2700



Double Jacket, Heavy-Duty Cable

Loose Tube — Outdoor

Applications

- Direct burial
- Harsh environments
- Applications requiring good ozone-, moisture- and weather-resistance

Product Description

Gel-filled buffer tube prevents water migration. Available with up to 216 fibers.

Jacket Material	
Outer Jacket:	PE
Inner Jacket:	PE
Buffer Tube	
	PBT
Strength Member	
	Aramid Yarn
Central Strength Member	
	E-Glass
Core Wrap	
	Water Swellable Tape
Color Code (Buffer)	
	Per EIA/TIA 598-A, see page 10.2
Jacket Color	
	Black

Specifications

Temperature Range	
Storage	-50 to +80°C
Operating	-40 to +70°C
Crush Resistance (EIA-455-41)	
	2000 N/cm
Impact Resistance (EIA-455-25)	
	2000 Impacts @ 1.6 N-m
Min. Bend Radius	
Installation	20 x OD
Long Term	15 x OD
Optical Specifications	
	See page 10.2

Fiber Bundle Detail

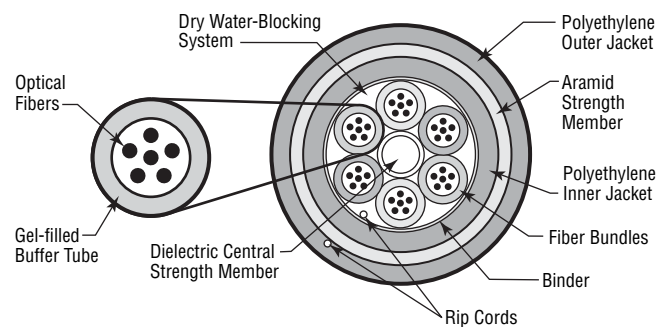

No. of Fibers	Fibers Per Tube	Belden Part Number				Outside Diameter		Weight		Max. Install Load	
		62.5 / 125µm Std. / 1 Gbe	50 / 125µm Std. / 1 Gbe	50 / 125µm 10 Gbe – 300M	Single-mode Enhanced	Inch	mm	Lbs./1000'	kg/km	Lbs.	N

Loose Tube Series — Heavy Duty

Outdoor											
2	2	M9B840	M9A840	M9C840	M9W840	0.44	11.18	60	89	600	2700
4	4	M9B841	M9A841	M9C841	M9W841	0.44	11.18	60	89	600	2700
6	6	M9B842	M9A842	M9C842	M9W842	0.44	11.18	60	89	600	2700
8	4	M9B843	M9A843	M9C843	M9W843	0.44	11.18	60	89	600	2700
12	6	M9B844	M9A844	M9C844	M9W844	0.44	11.18	60	89	600	2700
18	6	M9B845	M9A845	M9C845	M9W845	0.44	11.18	60	89	600	2700
24	6	M9B846	M9A846	M9C846	M9W846	0.44	11.18	60	89	600	2700
36	6	M9B847	M9A847	M9C847	M9W847	0.44	11.18	60	89	600	2700
48	12	M9B848	M9A848	M9C848	M9W848	0.54	13.72	136	202	600	2700
72	12	M9B849	M9A849	M9C849	M9W849	0.54	13.72	136	202	600	2700
96	12	M9B820	M9A820	M9C820	M9W820	0.61	15.37	152	226	600	2700
144	12	M9B821	M9A821	M9C821	M9W821	0.76	19.30	255	379	600	2700
216	12	M9B822	M9A822	M9C822	M9W822	0.76	19.30	255	379	600	2700

Central Tube Cable

Loose Tube—Outdoor, and Outdoor Armored

Applications

- Campus OSP backbones
- Drop cable
- Telecommunications and data trunk
- Direct burial (armored only)
- Lashed aerial

Product Description

Economical option for low fiber counts. Quick and easy end preparation. Fully waterblocked with gel-filled buffer tube. No rods – easy handling. Crush, impact and abrasion resistant.

Jacket Material	PE
Buffer Tube	PBT
Core Wrap	Water Swellable Tape
Strength Member	Fiberglass
Armor	Corrugated Steel
Color Codes (Jacket & Fibers)	Per EIA/TIA 598-A, see page 10.2
Jacket Color	Black

Specifications

Temperature Range	
Storage	-40 to +70°C
Operating	-40 to +70°C
Crush Resistance (EIA-455-41)	2000 N/cm
Impact Resistance (EIA-455-25)	2000 Impacts @ 1.6 N-m
Min. Bend Radius	
Installation	20 x OD
Long Term	15 x OD
Optical Specifications	See page 10.2

Fiber Bundle Detail

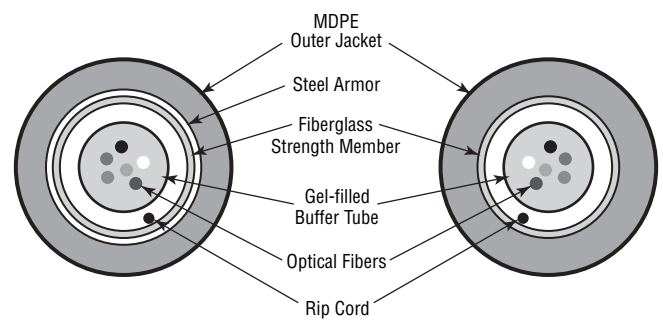

SINGLE ARMOR

ALL DIELECTRIC

No. of Fibers	Belden Part Number				Outside Diameter		Weight		Max. Install Load	
	62.5 / 125µm Std. / 1 Gbe	50 / 125µm Std. / 1 Gbe	50 / 125µm 10 Gbe – 300M	Single-mode Enhanced	Inch	mm	Lbs./1000'	kg/km	Lbs.	N

Central Tube Series

Outdoor										
2	M9B150	M9A150	M9C150	M9W150	0.325	8.26	36	54	600	2700
4	M9B151	M9A151	M9C151	M9W151	0.325	8.26	36	54	600	2700
6	M9B152	M9A152	M9C152	M9W152	0.325	8.26	36	54	600	2700
8	M9B153	M9A153	M9C153	M9W153	0.325	8.26	36	54	600	2700
10	M9B154	M9A154	M9C154	M9W154	0.325	8.26	36	54	600	2700
12	M9B155	M9A155	M9C155	M9W155	0.325	8.26	36	54	600	2700
Outdoor Armored										
2	M9B170	M9A170	M9C170	M9W170	0.410	10.41	72	108	600	2700
4	M9B171	M9A171	M9C171	M9W171	0.410	10.41	72	108	600	2700
6	M9B172	M9A172	M9C172	M9W172	0.410	10.41	72	108	600	2700
8	M9B173	M9A173	M9C173	M9W173	0.410	10.41	72	108	600	2700
10	M9B174	M9A174	M9C174	M9W174	0.410	10.41	72	108	600	2700
12	M9B175	M9A175	M9C175	M9W175	0.410	10.41	72	108	600	2700

All optical fiber products can be supplied in compliance with RoHS regulations. Please contact Customer Service for more details.

Micro Loose Tube Breakout Style Cable

Loose Tube – Outdoor, Indoor/Outdoor OFN & Indoor/Outdoor Riser Rated

Applications

- Ducts between buildings (above or below frost lines)
- Lashed aerial
- Telecommunications and data trunk

Product Description

Easy handling and termination of a breakout style cable. Loose buffer dimensions compatible with standard connectors (900 µm). Waterblocking gel for moisture protection. Breakout kits not required for connectorization.

Jacket Material	
Outdoor	PE
Riser	PVC
General Purpose	TPE
Buffer tube	
Outdoor + Riser	PBT
Strength Elements	
	Aramid Yarn
Strength Member(s)	
	Upjacketed Aramid
Color Codes (Jacket & Fibers)	
	Per EIA/TIA 598-A, see page 10.2
Jacket Color	
	Black

Ratings

Riser	
UL Type	OFNR
cUL Type	OFN FT4
Flame Resistance	UL 1666
General Purpose	
UL/cUL Type	OFN
Flame Resistance	UL 1581

Specifications

Temperature Range	
Storage	-40 to +70°C
Operating	-20 to +70°C
Crush Resistance (EIA-455-41)	
	600 N/cm
Impact Resistance (EIA-455-25)	
	20 Impacts @ 1.0 N-m
Min. Bend Radius	
Installation	20 x OD
Long Term	15 x OD
Optical Specifications	
	See page 10.2

Fiber Bundle Detail

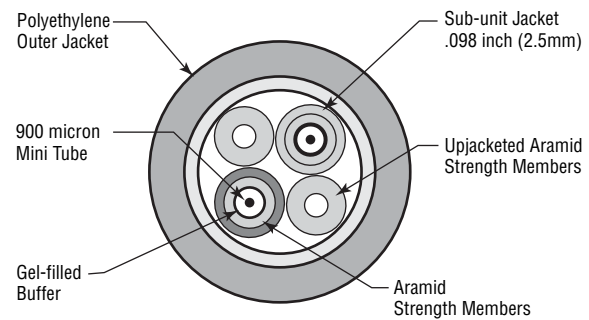

Micro Loose Tube Breakout Style CableLoose Tube – Outdoor, Indoor/Outdoor OFN & Indoor/Outdoor Riser Rated (*continued*)

No. of Fibers	Belden Part Number				Outside Diameter		Weight		Max. Install Load	
	62.5 / 125µm Std. / 1 Gbe	50 / 125µm Std. / 1 Gbe	50 / 125µm 10 Gbe – 300M	Single-mode Enhanced	Inch	mm	Lbs./1000'	kg/km	Lbs.	N
Micro Loose Tube Series										
Outdoor										
1	M9B700	M9A700	M9C700	M9W700	0.340	8.64	41	61	330	1468
2	M9B701	M9A701	M9C701	M9W701	0.360	9.14	41	61	345	1535
4	M9B702	M9A702	M9C702	M9W702	0.360	9.14	39	58	285	1267
6	M9B703	M9A703	M9C703	M9W703	0.418	10.62	54	80	405	1801
8	M9B704	M9A704	M9C704	M9W704	0.478	12.14	76	113	600	2700
12	M9B705	M9A705	M9C705	M9W705	0.614	15.60	129	192	600	2700
Indoor/Outdoor OFN										
1	M9B720	M9A720	M9C720	M9W720	0.344	8.74	50	74	330	1468
2	M9B721	M9A721	M9C721	M9W721	0.364	9.25	51	76	345	1535
4	M9B722	M9A722	M9C722	M9W722	0.364	9.25	49	73	285	1267
6	M9B723	M9A723	M9C723	M9W723	0.424	10.72	68	101	405	1801
8	M9B724	M9A724	M9C724	M9W724	0.482	12.24	77	115	600	2700
12	M9B725	M9A725	M9C725	M9W725	0.618	15.70	130	193	600	2700
Indoor/Outdoor Riser										
1	M9B740	M9A740	M9C740	M9W740	0.352	8.94	54	80	330	1468
2	M9B741	M9A741	M9C741	M9W741	0.372	9.45	55	82	345	1535
4	M9B742	M9A742	M9C742	M9W742	0.372	9.45	51	76	285	1267
6	M9B743	M9A743	M9C743	M9W743	0.432	10.97	74	110	405	1801
8	M9B744	M9A744	M9C744	M9W744	0.490	12.45	94	140	600	2700
12	M9B745	M9A745	M9C745	M9W745	0.626	15.90	151	229	600	2700

Please contact the Technical Support Group for proper connectivity integration and installation guidance.

TrayOptic® Heavy-Duty, All Dielectric Cable

Loose Tube — Indoor/Outdoor Riser Rated

Applications

- Industrial and other harsh environment applications
- Factory automation
- Direct burial

Product Description

Laser Optimized Fiber to handle Gigabit Ethernet light sources and expanded bandwidth requirements. Passes IEEE 383-2003 flame test. Waterblocking agent for moisture protection. CPE outer jacket option provides extra chemical or abrasion resistance.

Fiber Type	62.5/125μ
Jacket Material	PVC or CPE
Strength Member	Aramid Yarn
Jacket Color	Orange

Ratings

Riser	
UL Type	OFNR
cUL Type	OFN FT4
Flame Resistance	IEEE 383-2003

Specifications

Temperature Range	
Storage	-40 to +70°C
Operating	-40 to +70°C
Crush Resistance (EIA-455-41)	2000 N/cm
Impact Resistance (EIA-455-25)	2000 impacts @ 1.6N-m
Cyclic Flexing (EIA-455-104)	25 cycles, 12 lbs., 20 x OD radius min.
Min. Bend Radius	
Installation	20 x OD
Long Term	15 x OD
Maximum Installation Load	600 lbs. (2700 N)
Optical Specifications	See page 10.2

Fiber Bundle Detail

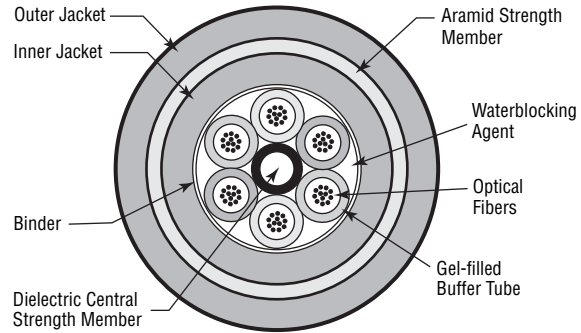

No. of Fibers	Fibers Per Tube	Outside Diameter		PVC Jacket			CPE Jacket		
		Inches	mm	Belden Part No.	Weight Lbs./1000'	Weight kg/km	Belden Part No.	Weight Lbs./1000'	Weight kg/km

TrayOptic Series

Riser (NEC/CEC OFNR/OFN FT4)									
2	2	0.440	11.18	I100255	88	131	I100266	83	124
4	4	0.440	11.18	I100455	88	131	I100466	83	124
6	6	0.440	11.18	I100655	88	131	I100666	83	124
8	4	0.440	11.18	I400855	88	131	I400866	83	124
12	6	0.440	11.18	I601255	88	131	I601266	83	124
18	6	0.440	11.18	I601855	88	131	I601866	83	124
24	6	0.440	11.18	I602455	88	131	I602466	83	124
36	6	0.440	11.18	I603655	88	131	I603666	83	124
48	12	0.540	13.72	I604855	136	202	I604866	129	192
60	12	0.540	13.72	I606055	136	202	I606066	129	192
72	12	0.540	13.72	I607255	136	202	I607266	129	192

Mouser Electronics

Authorized Distributor

Click to View Pricing, Inventory, Delivery & Lifecycle Information:

Belden Wire & Cable:

[AX102242](#) [AX102738](#) [AX101169](#) [AX350600](#) [AX102737](#) [AX102907](#) [AX101829](#) [AX102008](#) [AX102244](#) [AX102243](#)