



**晶体管光耦**  
**Photo Transistor**

**TLP185**

**Product Data Sheet**

**AOTE DCC**  
**RELEASE**

**台湾奥特半导体科技有限公司**

TAIWAN AOTE SEMICONDUCTOR TECHNOLOGY CO.,LTD

[www.aotesemi.com](http://www.aotesemi.com)

## 概述 Description

TLP185GB-S是一款由发光二极管和光电晶体管组成的光电耦合器。 四引脚封装（SOP）。

The TLP185GB-S is a photoelectric coupler composed of light-emitting diode and phototransistor. It is packaged in a 4-pin small outline SOP package.

## 特性 Features

- 电流转换比(CTR)范围: 80% ~600% ( $I_F = 5\text{mA}$ ,  $V_{CE} = 5\text{V}$ ,  $T_a = 25^\circ\text{C}$ )  
Current transfer ratio: 80% ~600% ( $I_F = 5\text{mA}$ ,  $V_{CE} = 5\text{V}$ ,  $T_a = 25^\circ\text{C}$ )
- 输入-输出隔离电压 ( $V_{ISO} = 3750 \text{ Vrms}$ )  
High isolation voltage between input and output ( $V_{ISO} = 3750 \text{ Vrms}$ )
- 集电极-发射极击穿电压  $BV_{CEO} \geq 80\text{V}$   
Collector - emitter breakdown voltage  $BV_{CEO} \geq 80\text{V}$
- 工作温度:  $-55^\circ\text{C} \sim +110^\circ\text{C}$   
Operating Temperature:  $-55^\circ\text{C} \sim +110^\circ\text{C}$
- 符合加强绝缘标准  
Meet reinforced insulation standards
- 符合安规标准: UL 1577, VDE DIN EN60747-5-5 (VDE 0884-5), CQC11-471543-2022  
Meet safety standard approval: UL 1577, VDE DIN EN60747-5-5 (VDE 0884-5), CQC11-471543-2022

## 应用 Applications

- 开关电源, 智能电表  
Switching power supply, intelligent meter
- 工业控制, 测量仪器  
Industrial control, measuring instruments
- 办公设备, 比如复印机  
Office equipment such as copiers
- 家用电器, 比如空调、风扇、热水器等  
Household appliances: such as air conditioners, fans, water heaters, etc.

## 封装和原理图 Package and Schematic Diagram



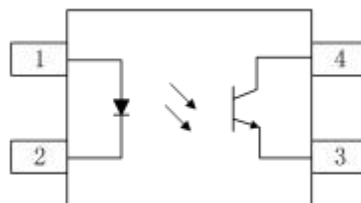

SOP4



Pin Configuration

1. Anode
2. Cathode
3. Emitter
4. Collector

## 印字信息 Marking Information

- 印字中 “” 为奥特品牌 LOGO  
 “” denotes LOGO
- 印字中的 “X” 代表产品分档：A、B、C、D、E、F或无  
 “X” denotes the classification：A、B、C、D、E、For None
- 印字中 “Y” 代表年份；A(2018),B(2019),C(2020) ... ..  
 “Y” denotes YEAR：A(2018), B(2019), C(2020) ... ..
- 印字中 “WW” 代表周号  
 “WW” denotes Week’ s number
- 印字中 “N” 代表星期几  
 “N” denotes day of the week
- 印字中的 “H” 代表无卤  
 “H” denotes Halogen-free



**绝缘和安规信息 Insulation and Safety related specifications**

项目 Item	符号 Symbol	数值 Value	单位 Unit	备注 Remark
爬电距离 Creepage Distance	L	>5.0	mm	从输入端到输出端，沿本体最短距离路径 Measured from input terminals to output terminals, shortest distance path along body
电气间隙 Clearance Distance	L	>5.0	mm	从输入端到输出端，通过空气的最短距离 Measured from input terminals to output terminals, shortest distance through air
绝缘距离 Insulation Thickness	DTI	>0.4	mm	发射器和探测器之间的绝缘厚度 Insulation thickness between emitter and detector
峰值隔离电压 Peak Isolation Voltage	$V_{IORM}$	600	$V_{peak}$	DIN/EN/IEC EN60747-5-5
瞬态隔离电压 Transient isolation voltage	$V_{IOTM}$	5000	$V_{peak}$	DIN/EN/IEC EN60747-5-5
隔离电压 Isolation Voltage	$V_{iso}$	>3750	$V_{rms}$	For 1 min

**极限参数 Absolute Maximum Ratings (Ta = 25°C)**

参数 Parameter		符号 Symbol	额定值 Rating	单位 Unit
发射端 Input	正向电流 Forward Current	$I_F$	50	mA
	反向电压 Reverse Voltage	$V_R$	6	V
	功耗 Power Dissipation	$P_D$	70	mW
	额定值降低因子(在 Ta = 90°C 以上) Power dissipation Derating factor (above Ta = 90°C)	$P_{DD}$	2.9	mW/°C
接收端 output	集电极功耗 Collector Power Dissipation	$P_C$	150	mW
	集电极电流 Collector Current	$I_C$	50	mA
	集电极-发射极电压 Collector-Emitter Voltage	$V_{CEO}$	80	V
	发射极-集电极电压 Emitter-Collector Voltage	$V_{ECO}$	6	V
隔离电压 Isolation Voltage	$V_{iso}$	3750	$V_{rms}$	
工作温度 Operating Temperature	$T_{opr}$	-55 ~ +110	°C	
存储温度 Storage Temperature	$T_{stg}$	-55 ~ +125	°C	
焊接温度 Soldering Temperature	$T_{sol}$	260	°C	

**产品特性参数 Electro-optical Characteristics (Ta = 25°C)**

参数 Parameter		符号 Symbol	条件 Condition	最小 Min.	典型 Typ.	最大 Max.	单位 Unit
发射端 Input	正向电压 Forward Voltage	$V_F$	$I_F = 20\text{mA}$	-	1.2	1.4	V
	反向电流 Reverse Current	$I_R$	$V_R = 4\text{V}$	-	-	10	$\mu\text{A}$
	输入电容 Terminal Capacitance	$C_t$	$V=0, f=1\text{KHz}$	-	30	250	pF
接收端 Output	集电极暗电流 Collector Dark Current	$I_{CEO}$	$V_{CE} = 20\text{V}$	-	-	100	nA
	集电极-发射极击穿电压 Collector-Emitter Breakdown Voltage	$BV_{CEO}$	$I_C = 0.1\text{mA}, I_F = 0\text{mA}$	80	-	-	V
	发射极-集电极击穿电压 Emitter-Collector Breakdown Voltage	$BV_{ECO}$	$I_E = 10\mu\text{A}, I_F = 0$	6	-	-	V
传输特性 Transfer Characteristics	电流传输比 Current Transfer Ratio	CTR*	$I_F = 5\text{mA}, V_{CE} = 5\text{V}$	80	-	600	%
	集电极-发射极饱和压降 Collector-Emitter Saturation Voltage	$V_{CE(sat)}$	$I_F = 20\text{mA}, I_C = 1\text{mA}$	-	0.1	0.2	V
	隔离电阻 Isolation Resistance	$R_{ISO}$	DC500V, 40 ~ 60% R.H.	$5 \times 10^{10}$	$1 \times 10^{11}$	-	$\Omega$
	隔离电容 Isolation capacitance	$C_{ISO}$	$V=0, f=1\text{MHz}$	-	0.6	1.0	pF
	截止频率 Cut-off Frequency	$F_C$	$V_{CE} = 5\text{V}, I_C = 2\text{mA}, R_L = 100\Omega, -3\text{dB}$	-	80	-	kHz
	上升时间 Rise Time	$T_r$	$V_{CE} = 2\text{V}, I_C = 2\text{mA}, R_L = 100\Omega$	-	4	18	$\mu\text{s}$
	下降时间 Fall Time	$T_f$	$V_{CE} = 2\text{V}, I_C = 2\text{mA}, R_L = 100\Omega$	-	3	18	$\mu\text{s}$

 注\*：电流传输比= $I_C/I_F \times 100\%$ 。

 Note\*：CTR= $I_C/I_F \times 100\%$ 。

**电流传输比分档表 CTR Classification Table ( $I_F = 5\text{mA}, V_{CE} = 5\text{V}, T_a = 25^\circ\text{C}$ )**

代码 Code	最小值 Min.	最大值 Max.
Y	50	150
GR	100	300
GB	100	600
BL	200	600
YH	75	150
GRL	100	200
GRH	150	300
BLL	200	400
None	50	600

**典型光电特性曲线 Typical Electro-Optical Characteristics Curves**

Fig.1 Current Transfer Ratio vs Forward Current

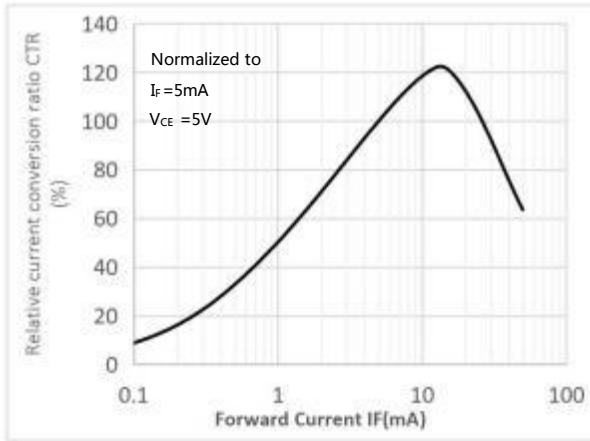

Fig.2 Forward Current vs. Forward Voltage

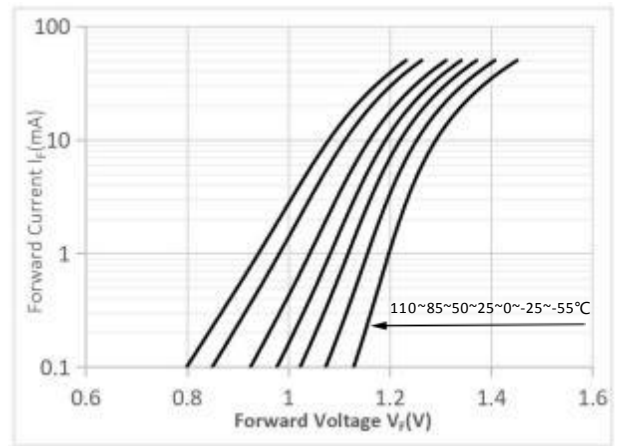

Fig.3 Collector Current vs. Collector-emitter Voltage

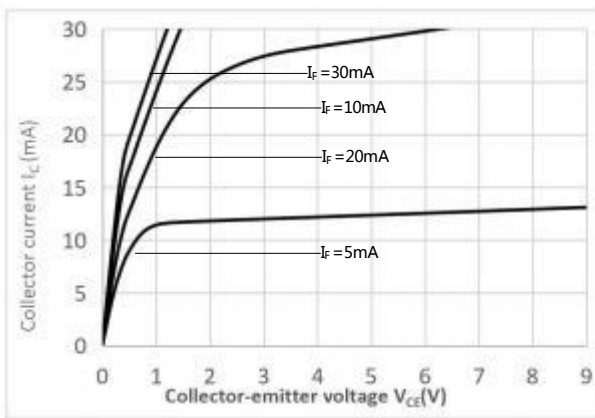

Fig.4 Relative Current Transfer Ratio vs. Ambient Temperature

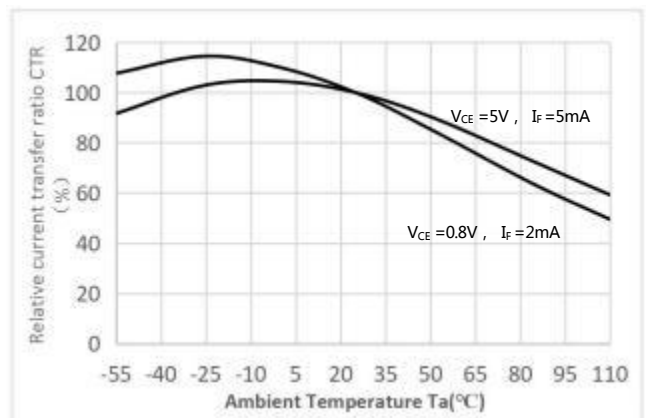

Fig.5 Collector-emitter Saturation Voltage vs. Ambient Temperature

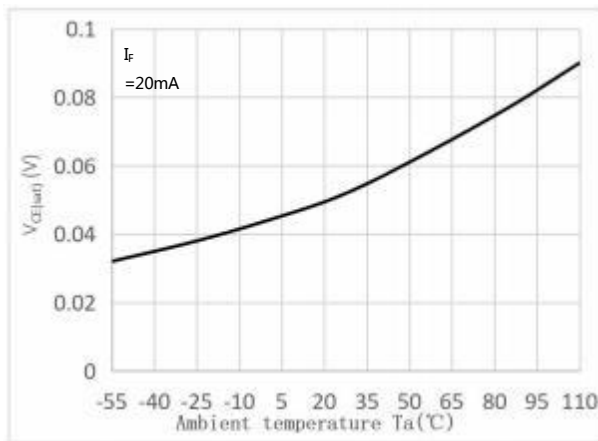

Fig.6 Collector Dark Current vs Ambient Temperature

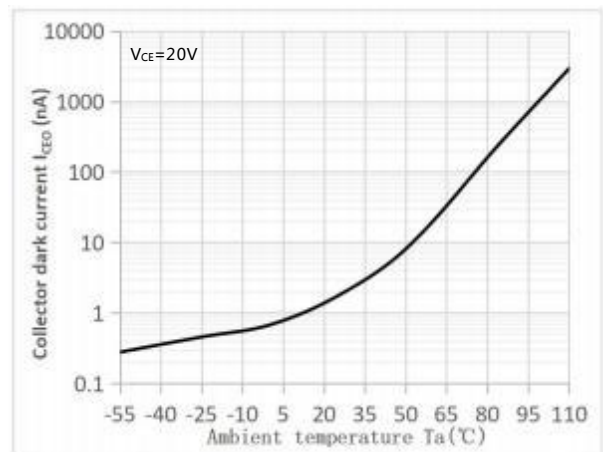

Fig.7 Response Time vs. Load Resistance

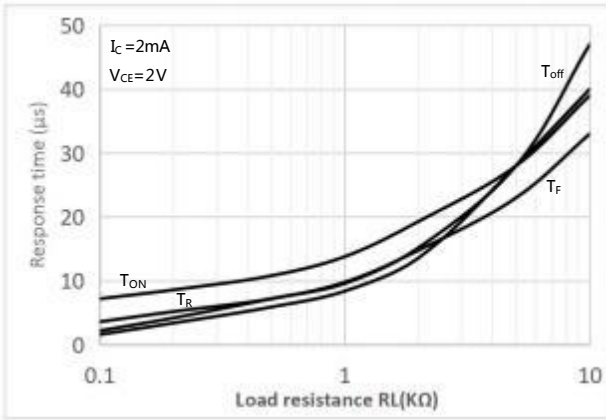

Fig.8 Frequency Response

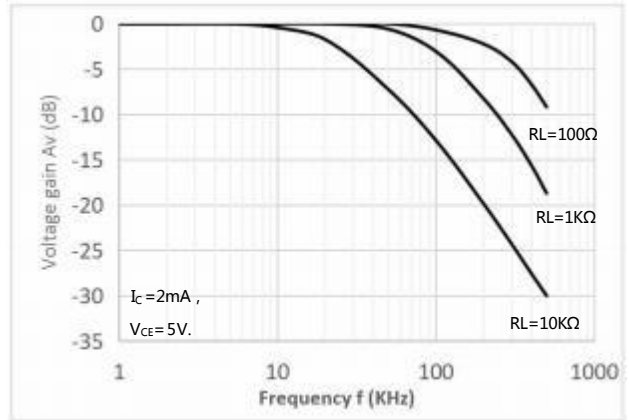

Fig.9 Collector-emitter Saturation Voltage vs Forward Current

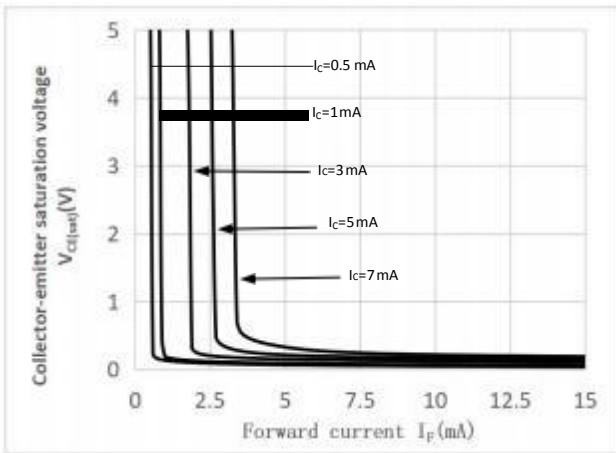
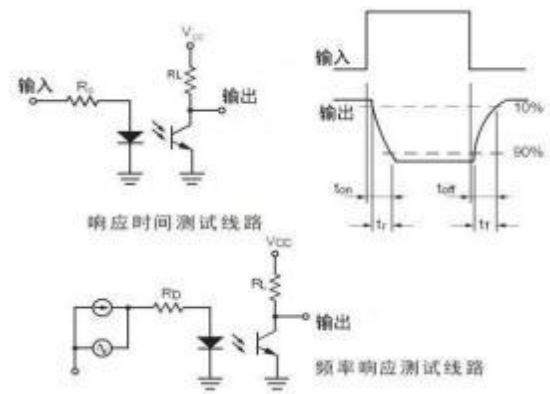
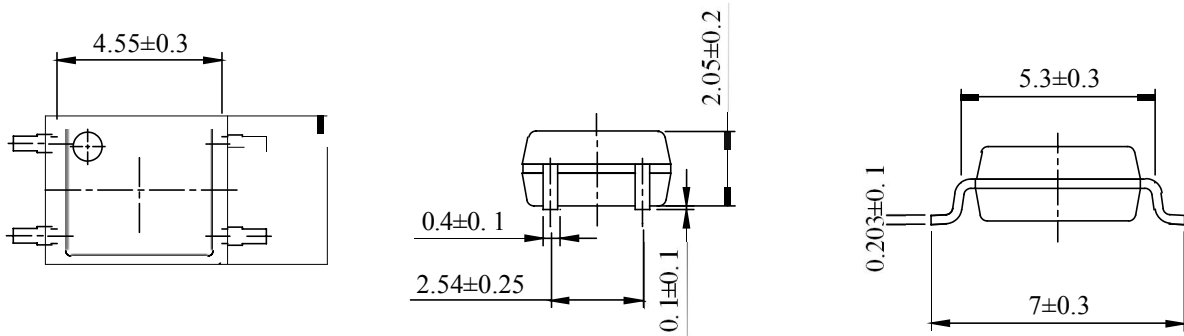

Fig.10 Switching Time Test Circuit & Waveforms



**外形尺寸 Outline Dimensions**

**SOP4**



单位 Unit: mm

**建议焊盘布局 Recommended Pad Layout**

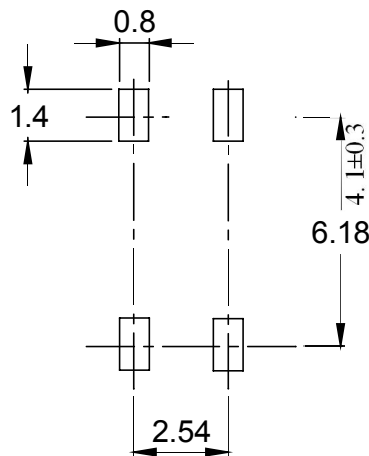

单位 Unit: mm

注：上图为产品正视图。  
Note : The picture above is the front view of the product.

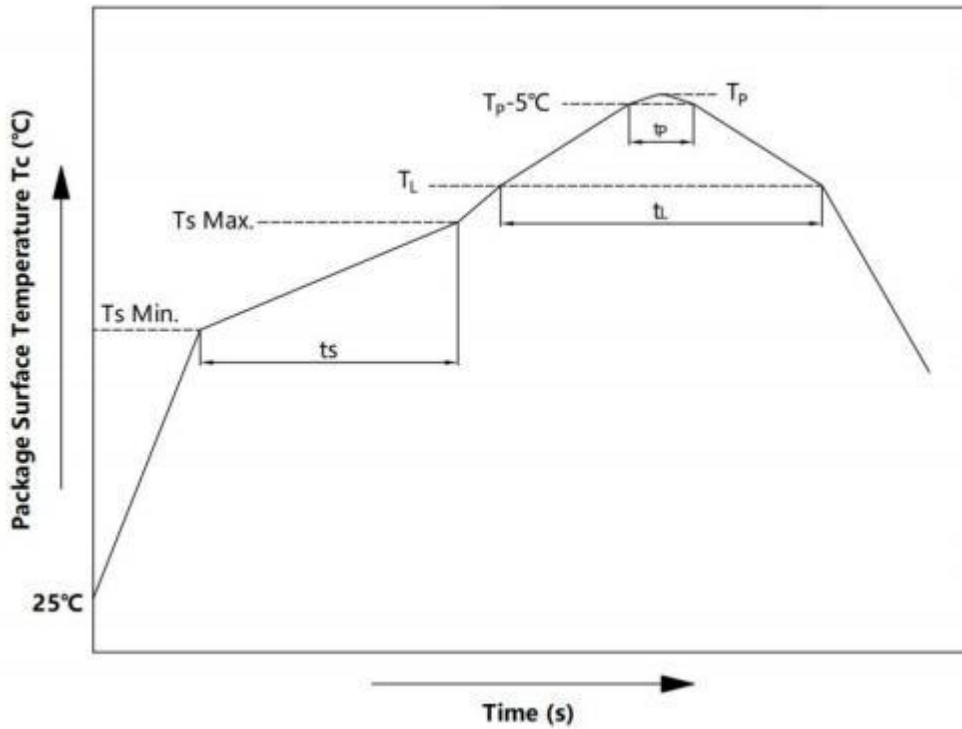

**回流焊温度曲线图 Solder Reflow Profile**

项目 Item	符号 Symbol	最小值 Min.	最大值 Max	单位 Unit
预热温度 Preheat Temperature	$T_s$	150	200	$^\circ\text{C}$
预热时间 Preheat Time	$t_s$	60	120	s
升温速率 Ramp-Up Rate ( $T_L$ to $T_p$ )	-	-	3	$^\circ\text{C}/\text{s}$
液相线温度 Liquidus Temperature	$T_L$	217		$^\circ\text{C}$
时间高于 $T_L$ Time Above $T_L$	$t_l$	60	150	s
峰值温度 Peak Temperature	$T_p$	-	260	$^\circ\text{C}$
$T_c$ 在 $(T_p - 5)$ 和 $T_p$ 之间的时间 Time During Which $T_c$ Is Between $(T_p - 5)$ and $T_p$	$t_p$	-	30	s
降温速率 Ramp-down Rate ( $T_p$ to $T_L$ )	-	-	6	$^\circ\text{C}/\text{s}$

注 Note :

建议在所示的温度和时间条件下进行回流焊，最多不能超过三次；

Reflow soldering is recommended at the temperatures and times shown, no more than three times;

### 波峰焊温度曲线图 Wave Soldering Profile

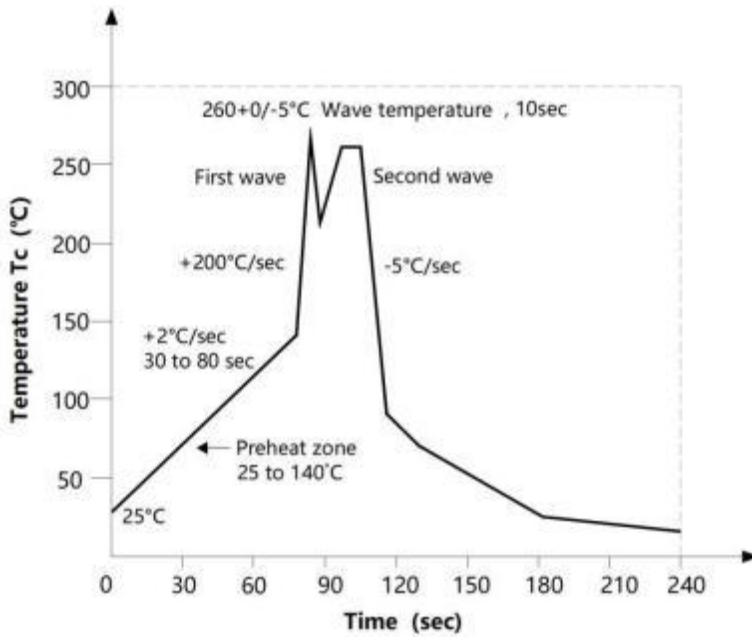

### 手工烙铁焊接 Soldering with hand soldering iron

- A. 手工烙铁焊仅用于产品返修或样品测试；  
Hand soldering iron is only used for product rework or sample testing;
- B. 手工烙铁焊要求：温度  $360^{\circ}\text{C} \pm 5^{\circ}\text{C}$ ，时间  $\leq 3\text{s}$ 。  
Hand soldering iron requirements：Temperature：  $360^{\circ}\text{C} \pm 5^{\circ}\text{C}$ , within 3s.

## 包装 Packing

### ■ 汇总表 Summary table

封装形式	包装方式	盘数量	盒数量	箱数量	静电袋规格	盒规格	箱(双瓦楞)规格	备注
SOP4	卷盘 ( $\phi 330\text{mm}$ 蓝盘)	3000 只/盘	2 盘/盒	10 盒/箱	450*390*0.1mm	340*60*340mm	620*360*365mm	首尾端空至少 200mm
Package Type	Packing Form	Quantity per Reel	Quantity per Box	Quantity per Carton	Antistatic Bag Specification	Box Specification	Carton Specification	Note
SOP4	Reel ( $\phi 330\text{mm}$ Blue)	3000 pcs /reel	2 reels /box	10 boxes /ctn	450*390*0.1mm	340*60*340mm	620*360*365mm	Guard band 200mm min.

### ■ 编带包装 Tape & Reel

- 1) 每卷数量：3000 只。  
Qty/reel：3000 pcs.
- 2) 每箱数量：60000 只。  
Qty/ctn：60000 pcs.
- 3) 内包装：每盒 2 盘。  
Inner packing：2 reels/box.
- 4) 示意图 Schematic：

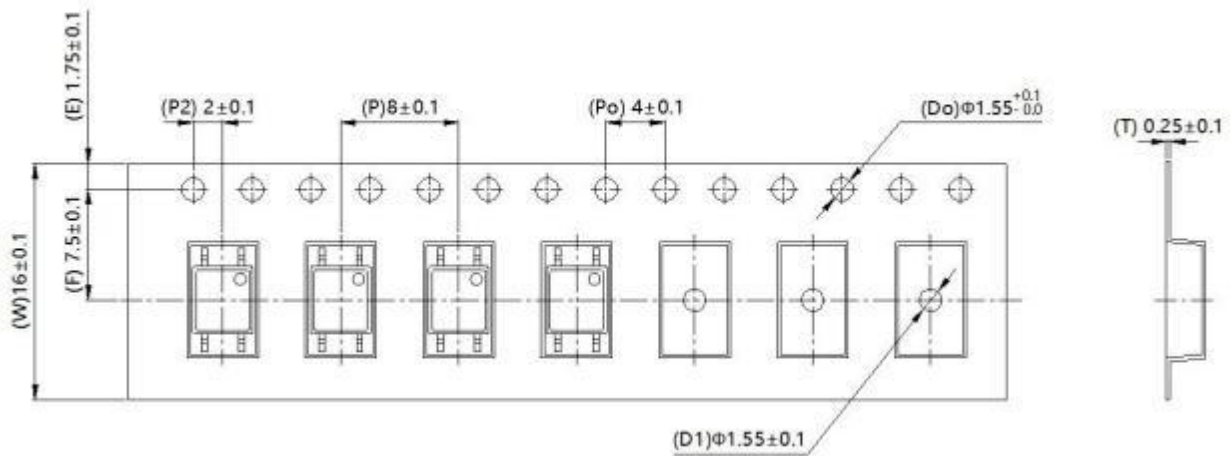

单位 Unit：mm

## 注意 Attention

- 奥特持续不断改进质量、可靠性、功能或设计，保留此文件更改的权利恕不另行通知。  
AOTE continuously improve quality, reliability, function and design. We reserve the right to change this document without prior notice.
- 请遵守产品规格书使用，奥特不对使用时不符合产品规格书条件而导致的质量问题负责。  
Please use in accordance with the product specification. AOTE is not responsible for the quality problems caused by non-compliance with the product specifications.
- 对于需要高可靠性或安全性的设备/装置需求，请联系我们的销售人员。  
For equipment/devices requiring high reliability or safety, please contact our sales representatives.
- 当需要用于任何“特定”应用时，请咨询我们的销售人员。  
When requiring a device for any “specific” application, please contact our sales in advice.
- 如对文件中表述的内容有疑问，欢迎联系我们。  
If you have any questions about the contents of the document, please contact us.