



高速光耦
High Speed Photo
Coupler

ATM5XX

Product Data Sheet

AOTE DCC
RELEASE

台湾奥特半导体科技有限公司

TAIWAN AOTE SEMICONDUCTOR TECHNOLOGY CO.,LTD

[www . aote se mi . co m](http://www.aotese mi .co m)

概述 Description

ATM501、ATM511 是一种用于单通道的高速光耦合器，由一个 850nm 的 AlGaAs LED 光学耦合到一个高速光电探测器组成。光电二极管偏极和输出晶体管集电极的单独连接，可以通过降低基极集电极电容，使速度比传统光电晶体管耦合器提高 100 倍。

The ATM501 ATM511 optocoupler consists of a 850 nm AlGaAs LED, optically coupled to a high speed photodetector transistor. A separate connection for the bias of the photodiode improves the speed by several orders of magnitude over conventional phototransistor optocouplers by reducing the base-collector capacitance of the input transistor.

特性 Features

- 高比特率：1MBit/s
High speed – 1 MBit/s
- 输入和输出之间的高隔离电压 (Viso = 3750 V rms)
High isolation voltage between input and output (Viso = 3750 V rms)
- 兼容 TTL
TTL Compatible
- 集电极开路输出
Open-Collector Output
- 符合安规标准：UL 1577，VDE DIN EN60747-5-5 (VDE 0884-5)，CQC11-471543-2022
Meet Safety standard：UL 1577, VDE DIN EN60747-5-5 (VDE 0884-5)，CQC11-471543-2022

应用 Applications

- CMOS- LSTTL-TTL 的输出接口
Output interface to CMOS-LSTTL-TTL
- 通信设备
Telecommunication equipment
- 电机驱动中的功率晶体管隔离
Power transistor isolation in motor drives
- 替代低速光电晶体管光电耦合器
Replacement for low speed phototransistor photocouplers

真值表 Truthtable

LED	VO
OFF	H
ON	L

封装和原理图 package and schematic Diagram



SOP5

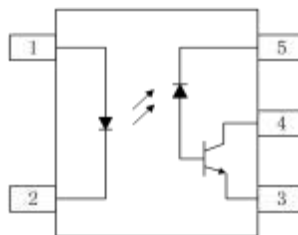

Pin Configuration

1. Anode
2. Cathode
3. GND
4. VO
5. VCC

注：在引脚 3 和 5 之间必须连接一个 0.1uF 的旁路电容器。

Note: 0.1uF bypass capacitor must be connected between pins 3 and 5.



产品型号命名规则 Order code

AT M5XX-UN Y-W(V)(ZZ)

① ② ③ ④ ⑤ ⑥ ⑦

- ① 公司代码 Company Code (AT: 奥特 Aote)
- ② 产品系列 Product Series (XX: 01, 11)
- ③ 框架类型 Lead Frame (Cu: 铜框架 Copper)
- ④ 树脂类型 Epoxy Type (H: 无卤 Halogen-free)
- ⑤ 封装形式 Package (S: SOP)
- ⑥ 器件工作温度范围 Device Operating Temperature Range (特殊范围需填或者空白 Special Range need to be filled in or left blank)
- ⑦ 内部补充代码 Internal Supplementary Code (数字或者空白 Number or None)

印字信息 Marking Information

- 印字中 “” 为奥特品牌 LOGO
“” denotes LOGO
- 印字中的 “XX” 代表产品分档：01、11
“XX” denotes the classification：01、11
- 印字中 “Y” 代表年份；A(2018),B(2019),C(2020)
“Y” denotes YEAR：A(2018), B(2019), C(2020)
- 印字中 “WW” 代表周号
“WW” denotes week’s number
- 印字中 “E” 代表内部代码
“E” denotes Internal code
- 印字中的 “H” 代表无卤
“H” denotes Halogen-free



绝缘和安规信息 Insulation and safetyrelated specifications

项目 Item	符号 Symbol	数值 Value	单位 Unit	备注 Remark
爬电距离 Creepage Distance	L	>5.0	mm	从输入端到输出端，沿本体最短距离路径 Measured from input terminals to output terminals, shortest distance path along body
电气间隙 Clearance Distance	L	>5.0	mm	从输入端到输出端，通过空气的最短距离 Measured from input terminals to output terminals, shortest distance through air
绝缘距离 Insulation Thickness	DTI	>0.4	mm	发射器和探测器之间的绝缘厚度 Insulation thickness between emitter and detector
峰值隔离电压 Peak Isolation Voltage	V_{IORM}	600	V_{peak}	DIN/EN/IEC EN60747-5-5
瞬态隔离电压 Transient isolation voltage	V_{IOTM}	5000	V_{peak}	DIN/EN/IEC EN60747-5-5
隔离电压 Isolation Voltage	V_{iso}	>3750	V_{rms}	For 1 min

极限参数Absolute Maximum Ratings($T_a=25^{\circ}C$)

参数 Parameter		符号 Symbol	额定值 Rating	单位 Unit
发射端 Input	正向电流(平均) DC/Average Forward Input Current	$I_{F(avg)}$	25	mA
	正向峰值电流 (50%占空比, 1ms p.w.) Peak forward input current (50% duty cycle, 1 ms p.w.)	$I_{F(pk)}$	50	mA
	反向电压 Reverse Input Voltage	V_R	5.0	V
	正向瞬态峰值电流 ($\leq 1 \mu s$ p.w, 300pps) Peak transient input current ($\leq 1 \mu s$ p.w., 300 pps)	$I_{F(trans)}$	1	A
	输入功耗 Input Power Dissipation	P_i	45	mW
接收端 output	电源电压 Supply Voltage	V_{CC}	-0.5 ~ 30	V
	输出电流 Output Current	I_o	8	mA
	输出电流峰值 Peak output current	$I_{O(pk)}$	16	mA
	输出集电极功耗 Output Collector power dissipation	P_o	100	mW
	输出电压 Output Voltage	V_o	-0.5 to 20	V
工作温度 Operating Temperature	T_{opr}	-40 ~ +100	$^{\circ}C$	
存储温度 Storage Temperature	T_{stg}	-55 ~ +125	$^{\circ}C$	
焊接温度 Soldering Temperature	T_{sol}	260	$^{\circ}C$	

推荐操作条件 Recommended operating conditions

参数 Parameter	符号 Symbol	最小值 Min	最大值 Max	单位 Unit
电源电压 Power Supply Voltage	V_{CC}	4.5	18	V
开启电流 Forward Input Current (ON)	$I_{F(ON)}$	2	20.0	mA
关断电压 Forward Input Voltage (OFF)	$V_{F(OFF)}$	0	1.2	V
操作温度 Operating Temperature	T_A	-40	+100	°C

产品特性参数 Electro-optical characteristics(Ta=25°C)

参数 Parameter		符号 Symbol	条件 Condition	最小 Min.	典型 Typ.	最大 Max.	单位 Unit
发射端 Input	正向电压 Forward Voltage	V_F	$I_F = 16\text{mA}$	-	1.45	1.7	V
	反向击穿电压 Reverse Breakdown Voltage	B_{VR}	$I_R = 10\mu\text{A}$	5	20	-	V
	正向电压温度系数 Diode Temperature Coefficient	$\Delta V_F / \Delta T_A$	$I_F = 10\text{mA}$	-	-1.6	-	mV/°C
接收端 Output	高电平电源电流 High Level Supply Current	I_{CCH}	$V_{CC} = 15\text{V}$ $I_F = 0\text{mA}$ $V_O = \text{Open}$	-	-	1	μA
			$T_A = 0-70^\circ\text{C}$	-	-	2	μA
	低电平电源电流 Low Level Supply Current	I_{CCL}	$V_{CC} = 15\text{V}$ $I_F = 16\text{mA}$ $V_O = \text{Open}$	-	120	800	μA
传输特性 Transfer Characteristics	高电平输出电流 HIGH Level Output Current	I_{OH}	$I_F = 0\text{mA}$ $V_O = V_{CC} = 5.5\text{V}$	-	0.001	0.5	μA
			$I_F = 0\text{mA}$ $V_O = V_{CC} = 15\text{V}$	-	0.005	1	
			$T_A = 0-70^\circ\text{C}$	-	-	50	
	低电平输出电压 LOW Level Output Voltage	V_{OL}	$I_F = 16\text{mA}$ $V_{CC} = 4.5\text{V}$ $I_O = 3.0\text{mA}$	-	0.1	0.4	V
			$I_F = 16\text{mA}$ $V_{CC} = 4.5\text{V}$ $I_O = 2.4\text{mA}$	-	0.1	0.5	V
	电流传输比 Current transfer ratio	CTR	$I_F = 16\text{mA}$ $V_{CC} = 4.5\text{V}$ $V_O = 0.4\text{V}$	19	-	-	%
$I_F = 16\text{mA}$ $V_{CC} = 4.5\text{V}$ $V_O = 0.5\text{V}$			15	-	-		
隔离电压 Isolation Voltage	V_{ISO}	$RH < 50\%$ $T_A = 25^\circ\text{C}$ $I_{I-O} \leq 50\mu\text{A}$	3750	-	-	VRMS	
隔离电阻 Resistance (Input to Output)	R_{I-O}	$V_{I-O} = 500\text{V}$	-	10^{12}	-	Ω	
隔离电容 Capacitance (Input to Output)	C_{I-O}	$f = 1\text{MHz}$	-	0.6	-	pF	

开关特性 switching specification

参数 Parameter	符号 Symbol	条件 Condition	最小 Min.	典型 Typ.	最大 Max.	单位 Unit
输出高电平传播延迟时间 Propagation Delay Time to Output HIGH Level	T _{PLH}	I _F = 16mA R _L = 1.9kΩ T _A = 25°C	-	150	800	ns
		I _F = 16mA R _L = 1.9kΩ			800	
输出低电平传播延迟时间 Propagation Delay Time to Output Low Level	T _{PHL}	I _F = 16mA R _L = 1.9kΩ T _A = 25°C	-	200	800	ns
		I _F = 16mA R _L = 1.9kΩ			800	
逻辑高电平共模瞬态抗扰度 Common Mode Transient Immunity(at Logic High)	M501	CM _H	T _A = 25°C, I _F = 0mA VCM = 10V(Peak) C _L = 15pF, R _L = 1.9KΩ	5000	-	V/μs
	M511		T _A = 25°C, I _F = 0mA VCM = 1500V(Peak) C _L = 15pF, R _L = 1.9KΩ	15000	-	
逻辑低电平共模瞬态抗扰度 Common Mode Transient Immunity (at Logic Low)	M501	CM _L	T _A = 25°C, I _F = 16mA VCM = 10V(Peak) C _L = 15pF, R _L = 1.9KΩ	5000	-	V/μs
	M511		T _A = 25°C, I _F = 16mA VCM = 1500V(Peak) C _L = 15pF, R _L = 1.9KΩ	15000	-	

典型光电特性曲线 Typical Electro-optical characteristics curves

Fig.1 Normalized CTR vs. Input current

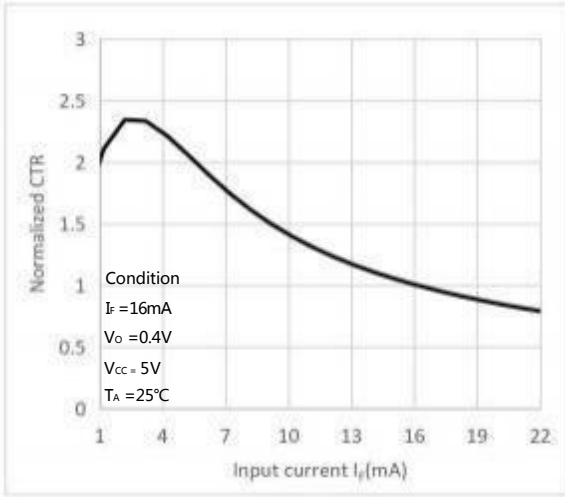

Fig.2 Normalized CTR vs. Ambient temperature

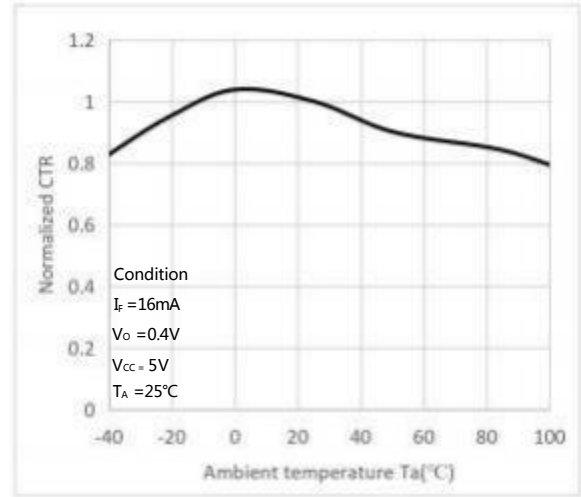

Fig.3 Output current vs. Output voltage

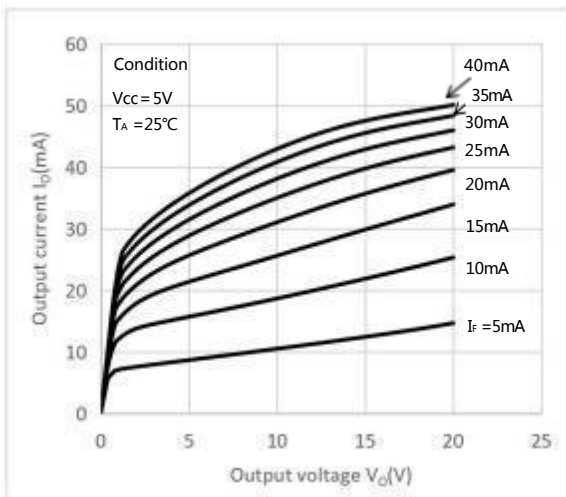

Fig.4 High level output current vs. Ambient temperature

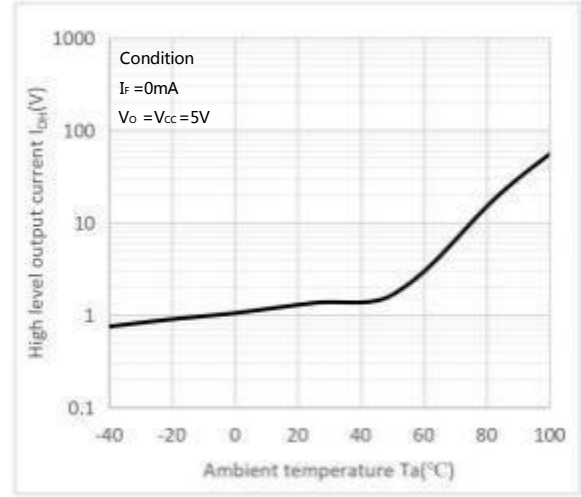

Fig.5 Propagation delay vs. Ambient temperature

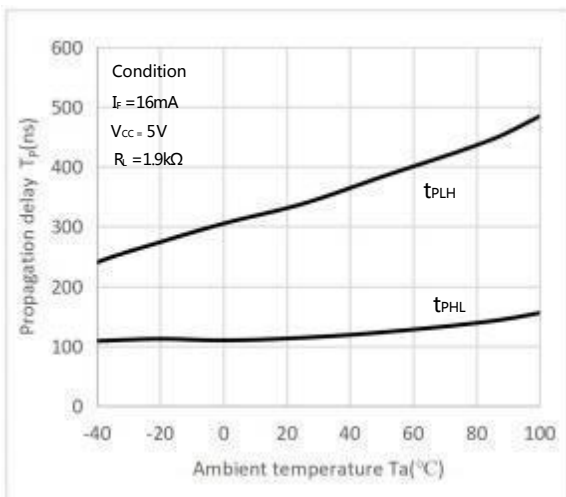
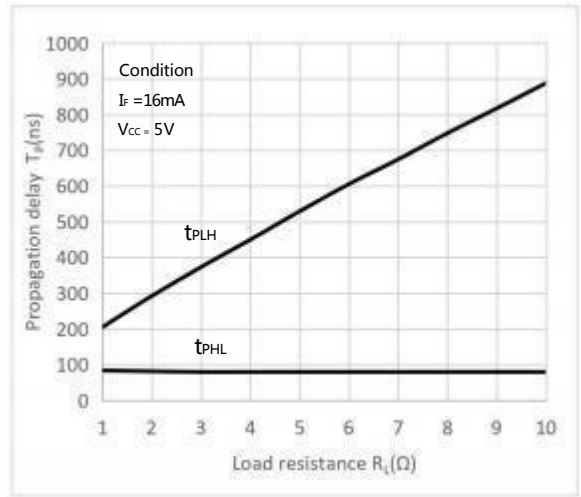
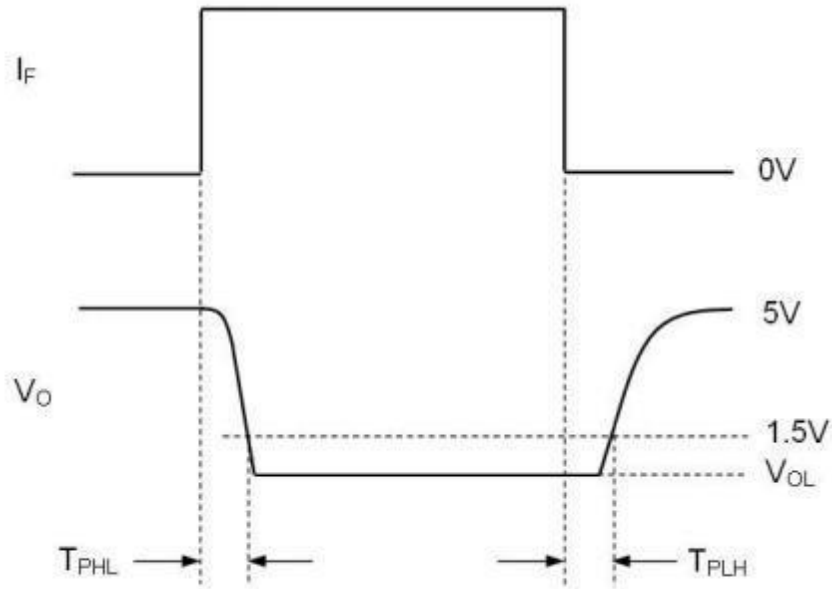
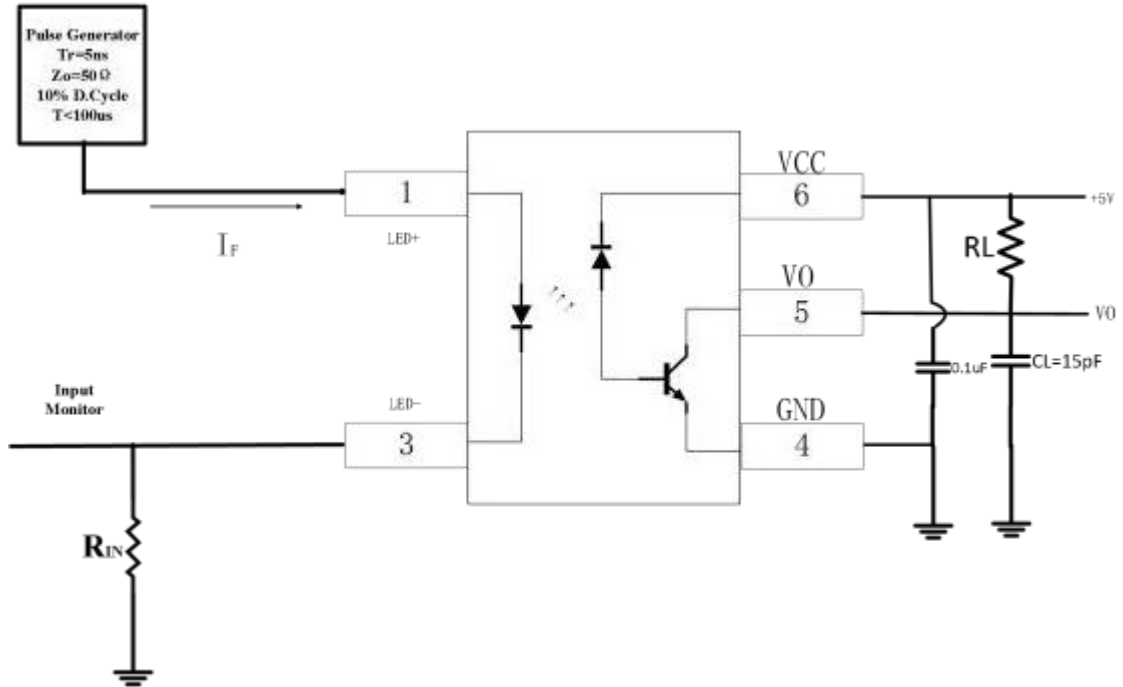

Fig.6 Propagation delay vs. Load resistance



延迟时间测试电路 propagationDelayTimeTestcircuit



CMR测试电路 Test circuit for common Mode Transient Immunity

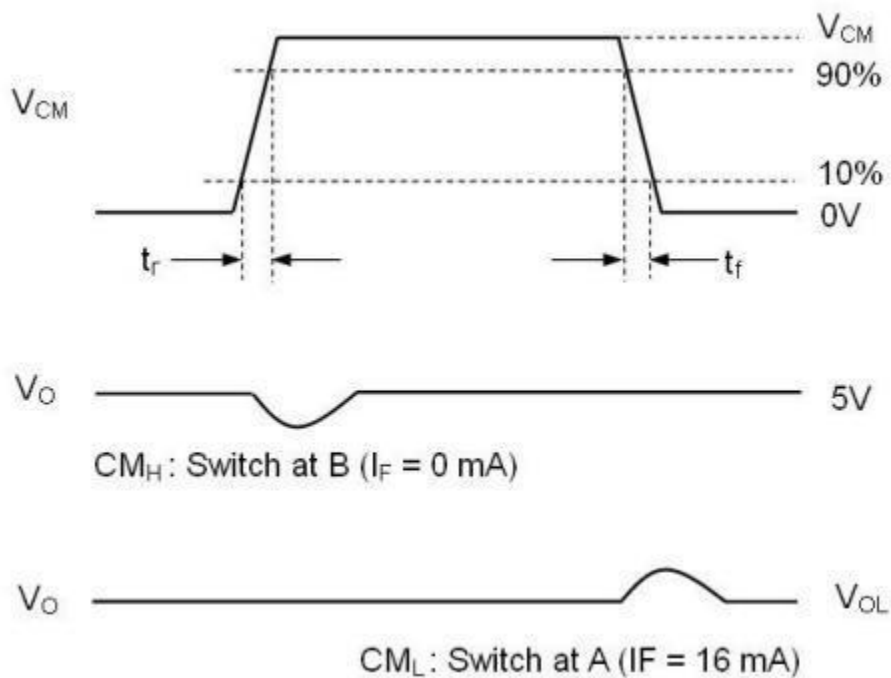
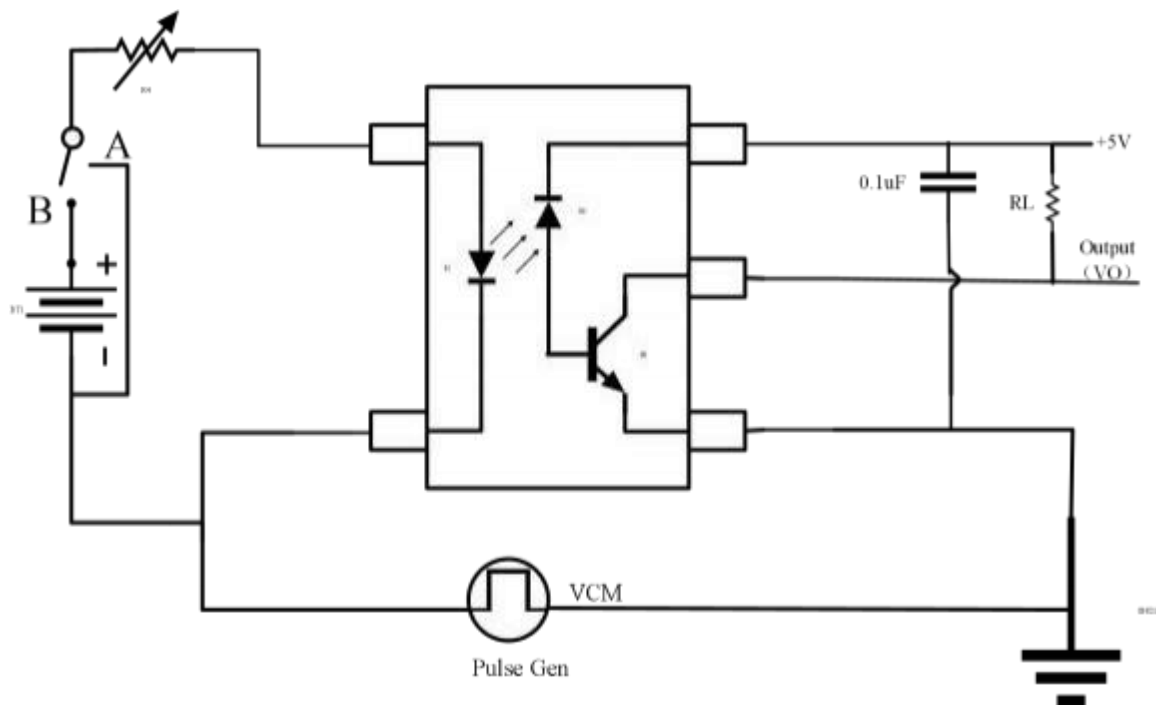

外形尺寸 Outline Dimensions

SOP5

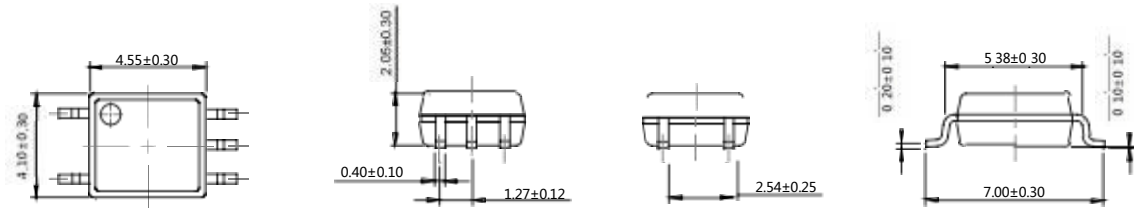

单位 Unit: mm

建议焊盘布局 Recommended pad Layout

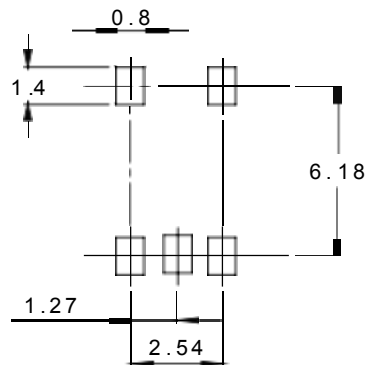

单位 Unit: mm

注：上图为产品正视图。

Note: The picture above is the front view of the product.

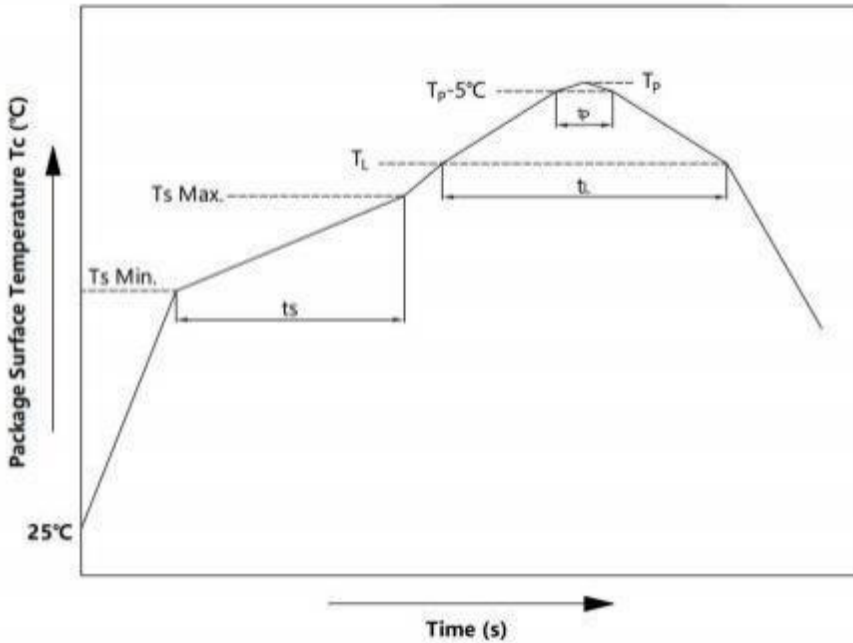
回流焊温度曲线图 solder Reflow profile

项目 Item	符号 Symbol	最小值 Min.	最大值 Max	单位 Unit
预热温度 Preheat Temperature	Ts	150	200	°C
预热时间 Preheat Time	ts	60	120	s
升温速率 Ramp-Up Rate (T _L to T _P)	-	-	3	°C/s
液相线温度 Liquidus Temperature	T _L	217		°C
时间高于 T _L Time Above T _L	t _L	60	150	s
峰值温度 Peak Temperature	T _P	-	260	°C
T _c 在(T _P -5)和 T _P 之间的时间 Time During Which T _c Is Between (T _P -5) and T _P	t _p	-	30	s
降温速率 Ramp-down Rate(T _P to T _L)	-	-	6	°C/s

注 Note :

建议在所示的温度和时间条件下进行回流焊，最多不能超过三次；

Reflow soldering is recommended at the temperatures and times shown, no more than three times;

波峰焊温度曲线图 waves olding profile

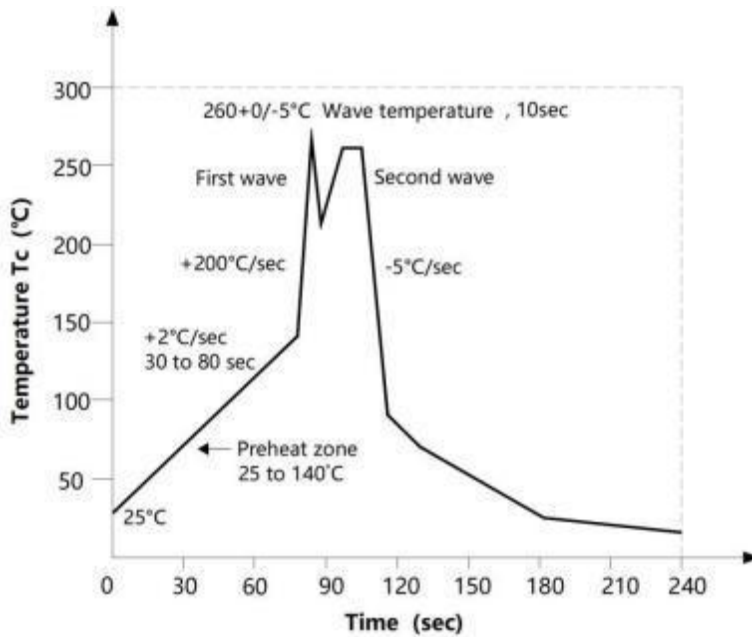

手工烙铁焊接 soldering with hand soldering iron

- A. 手工烙铁焊仅用于产品返修或样品测试；
Hand soldering iron is only used for product rework or sample testing;
- B. 手工烙铁焊要求：温度 $360^{\circ}\text{C} \pm 5^{\circ}\text{C}$ ，时间 $\leq 3\text{s}$ 。
Hand soldering iron requirements：Temperature： $360^{\circ}\text{C} \pm 5^{\circ}\text{C}$ ，within 3s.

包装 packing

■ 汇总表summary table

封装形式	包装方式	盘数量	盒数量	箱数量	静电袋规格	盒规格	箱(双瓦楞)规格	备注
SOP5	编带 ($\phi 330$ mm蓝)	3k/盘	2 盘/盒	10 盒/箱	450*390*0.1mm	340*60*340mm	620*360*365mm	保护带 200mm (min)
Package Type	Packing Form	Quantity per Reel	Quantity per Box	Quantity per Carton	Antistatic Bag Specification	Box Specification	Carton Specification	Note
SOP5	Reel($\phi 330$ mm Blue)	3k pcs/reel	2 reels /box	10 boxes /ctn	450*390*0.1mm	340*60*340mm	620*360*365mm	Guard band 200mm min.

■ 编带包装Tape&Reel

- 1) 每卷数量：3000 只。
Qty/reel：3000 pcs.
- 2) 每箱数量：60000 只。
Qty/ctn：60000 pcs.
- 3) 内包装：每盒 2 盘。
Inner packing：2 reels/box.
- 4) 示意图 Schematic：

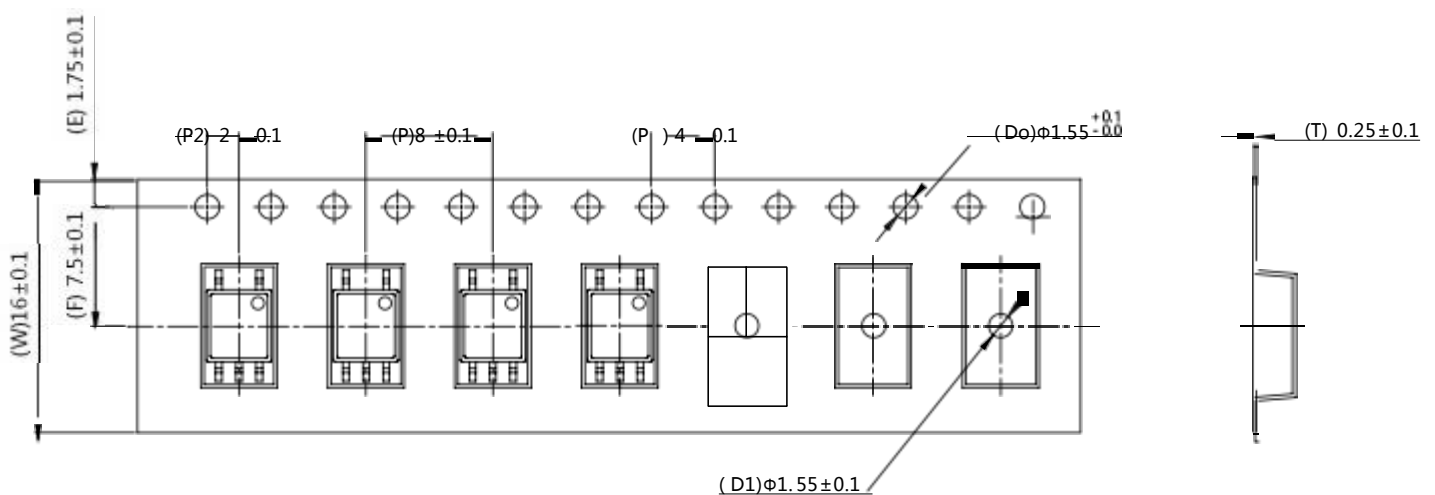

单位 Unit：mm

注意 Attention

- 奥特持续不断改进质量、可靠性、功能或设计，保留此文件更改的权利恕不另行通知。
AOTE continuously improve quality, reliability, function and design. We reserve the right to change this document without prior notice.
- 请遵守产品规格书使用，奥特不对使用时不符合产品规格书条件而导致的质量问题负责。
Please use in accordance with the product specification. AOTE is not responsible for the quality problems caused by non-compliance with the product specifications.
- 对于需要高可靠性或安全性的设备/装置需求，请联系我们的销售人员。
For equipment/devices requiring high reliability or safety, please contact our sales representatives.
- 当需要用于任何“特定”应用时，请咨询我们的销售人员。
When requiring a device for any “specific” application, please contact our sales in advice.
- 如对文件中表述的内容有疑问，欢迎联系我们。
If you have any questions about the contents of the document, please contact us.