

# UM11298

## EV-INVERTER Enablement kit user guide

Rev. 1 — 4 October 2019

User manual

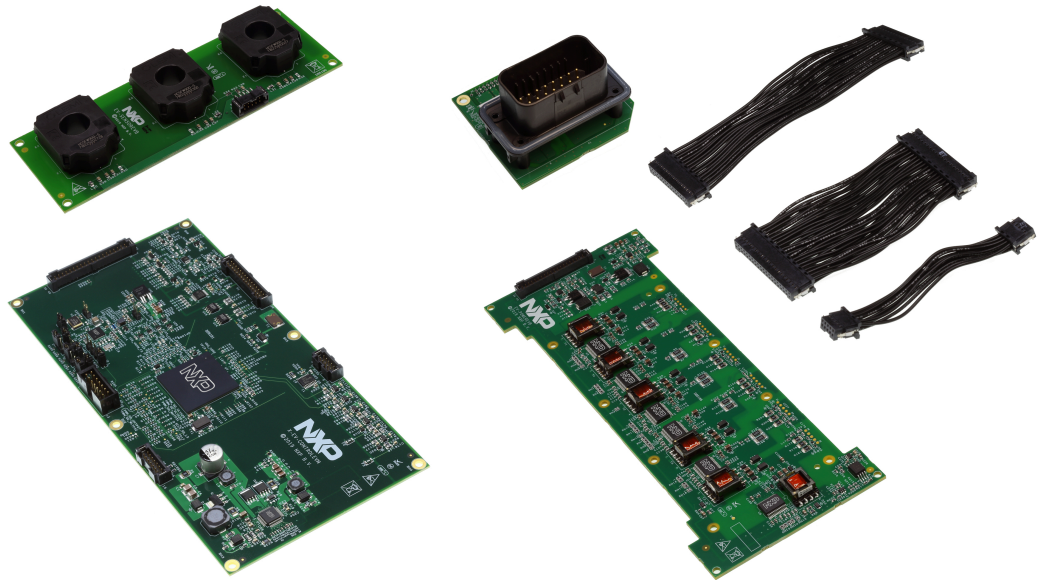

### Important Notice

NXP provides the enclosed product(s) under the following conditions:

This evaluation kit is intended for use of ENGINEERING DEVELOPMENT OR EVALUATION PURPOSES ONLY. It is provided as a sample IC pre-soldered to a printed circuit board to make it easier to access inputs, outputs, and supply terminals. This evaluation board may be used with any development system or other source of I/O signals by simply connecting it to the host MCU or computer board via off-the-shelf cables. This evaluation board is not a Reference Design and is not intended to represent a final design recommendation for any particular application. Final device in an application will be heavily dependent on proper printed circuit board layout and heat sinking design as well as attention to supply filtering, transient suppression, and I/O signal quality.

The goods provided may not be complete in terms of required design, marketing, and/or manufacturing related protective considerations, including product safety measures typically found in the end product incorporating the goods. Due to the open construction of the product, it is the user's responsibility to take any and all appropriate precautions with regard to electrostatic discharge. In order to minimize risks associated with the customer's applications, adequate design and operating safeguards must be provided by the customer to minimize inherent or procedural hazards. For any safety concerns, contact NXP sales and technical support services.

Should this evaluation kit not meet the specifications indicated in the kit, it may be returned within 30 days from the date of delivery and will be replaced by a new kit.

NXP reserves the right to make changes without further notice to any products herein. NXP makes no warranty, representation or guarantee regarding the suitability of its products for any particular purpose, nor does NXP assume any liability arising out of the application or use of any product or circuit, and specifically disclaims any and all liability, including without limitation consequential or incidental damages. "Typical" parameters can and do vary in different applications and actual performance may vary over time. All operating parameters, including "Typical", must be validated for each customer application by customer's technical experts.

NXP does not convey any license under its patent rights nor the rights of others. NXP products are not designed, intended, or authorized for use as components in systems intended for surgical implant into the body, or other applications intended to support or sustain life, or for any other application in which the failure of the NXP product could create a situation where personal injury or death may occur.

Should the Buyer purchase or use NXP products for any such unintended or unauthorized application, the Buyer shall indemnify and hold NXP and its officers, employees, subsidiaries, affiliates, and distributors harmless against all claims, costs, damages, and expenses, and reasonable attorney fees arising out of, directly or indirectly, any claim of personal injury or death associated with such unintended or unauthorized use, even if such claim alleges NXP was negligent regarding the design or manufacture of the part.



## 1 Finding kit resources and information on the NXP web site

The NXP analog product development boards provide an easy-to-use platform for evaluating NXP products. The boards support a range of analog, mixed-signal and power solutions. They incorporate monolithic integrated circuits and system-in-package devices that use proven high-volume technology. NXP products offer longer battery life, a smaller form factor, reduced component counts, lower cost and improved performance in powering state-of-the-art systems. NXP Semiconductors provides online resources for this reference design and its supported device(s) on <http://www.nxp.com>. The information page for EV traction motor reference design is at [EV Power Inverter Reference Platform](#). The information page provides overview information, specifications, ordering information, documentation and software. The Documents and Software tab provides quick-reference information applicable to using the EV-INVERTER Enablement Kit, including the downloadable assets referenced in this document.

### 1.1 Collaborate in the NXP Community

The NXP Community is for sharing ideas and tips, ask and answer technical questions, and receive input on just about any embedded design topic.

The NXP Community is at <https://community.nxp.com/community/s32>.

## 2 Getting started

The NXP analog product development boards provide an easy-to-use platform for evaluating NXP products. These development boards support a range of analog, mixed-signal, and power solutions. These boards incorporate monolithic integrated circuits and system-in-package devices that use proven high-volume technology. NXP products offer longer battery life, a smaller form factor, reduced component counts, lower cost, and improved performance in powering state-of-the-art systems.

### **Note:**

*Read this manual in its entirety before connecting the Power Inverter Module (PIM) to any power source. When operating in a lab environment, make sure all high-voltage connections are secured. and the operator is properly protected from any shock hazard.*

### 2.1 Kit contents

The enablement kit (EV-INVERTER) kit includes:

- MCU control board (EV-CONTROLEVM)
- Driver control board (EV-POWЕРЕVB)
- Sensor board (EV-SENSOREVB)
- Interface Board (EV-INTERFACEVB)
- PCB Interconnect cables (EV-HW-INVERTER)

### 2.2 Additional hardware

In addition to the kit contents, the following hardware is necessary or beneficial when working with this kit. As a service to customers to speed development, a complete EV Inverter Platform can be purchased from our development partner Vepco Technologies.

- **Fuji IGBT M653 Module:** Available for purchase from Fuji Electric, Inc. by authorized customers of the NXP EV Inverter Enablement Kit. [https://www.fujielectric.com/products/semiconductor/model/igbt/ev\\_hev\\_module.html](https://www.fujielectric.com/products/semiconductor/model/igbt/ev_hev_module.html)
- **Cooling plate or water jacket for IGBT Fuji IGBT M653 Module:** The cold plate serves as the cooling structure interface for the IGBT module and it functions as mechanical support to the Power Inverter Module (PIM) electronics and accessory components. Provide a cooling plate of your own design or purchase the complete platform from our inverter partner Vepco Technologies. <http://www.vepcotech.com/>
- **DC link capacitor:** Four EZP-E50117MTA 500 V 110  $\mu$ F film capacitors connected in parallel are used for inverter baseline performance measurements. Selected capacitor must be compatible with the IGBT listed above and intended operating voltages.
- **Bus bar:** Provide your own design or available when purchasing the complete platform from Vepco Technologies: <http://www.vepcotech.com/>
- **High-voltage cabling:** Provide your own or available when purchasing the complete platform from Vepco Technologies: <http://www.vepcotech.com/>
- **23-position signal connector:** (Ampseal<sup>®</sup> PN 770680-1) [TE Connectivity-770680-1](http://www.te-connectivity.com/TE-Connectivity-770680-1)
- **Mounting hardware:** Provide your own or available when purchasing the complete platform from Vepco Technologies: <http://www.vepcotech.com/>
- **Power supply:** Up to 500 V, 400 A
- **CAN Interface link**
- **Motor:** Provide your own or available from Vepco Technologies: <http://www.vepcotech.com/>

## 2.3 Interface connections

**High-voltage interface:** Must be 8 mm away from any other terminals and between each terminal:

- Two terminal DC connection – inputs V+ and V– from high voltage power supply connected via bus bar to IGBT module.
- Three terminal AC connection – outputs are U, V, W phase from IGBT module.

## 2.4 Windows PC workstation

This evaluation board requires a Windows PC workstation. Meeting these minimum specifications should produce great results when working with this evaluation kit.

- Windows 10, 8 or 7 compatible PC with an available USB port

## 2.5 Software

Installing software is necessary to work with this reference design. All listed software is available on the reference design's information page at <http://www.nxp.com/HV-INVERTER>. The software bundle includes the actual application software that runs on the Inverter Kit. This will also be available as a download on the Inverter page.

- S32S Design Studio IDE for power architecture
- Automotive Math and Motor Control Library (AMMCL)
- FreeMaster 2.0 runtime debugging tool
- Motor Control Application Tuning (MCAT)
- Example code, GD3100 Device Driver notes and GD3100 Device Driver Reference notes

## 3 Getting to know the hardware

### 3.1 Enablement kit overview

The EV-INVERTER is a reference design enablement kit containing NXP content to develop an EV three-phase traction motor inverter. The system is designed to drive the Fuji M653 IGBT module. This kit includes four PCBs as described above, three cables used to interconnect the PCBs and basic configuration and drive software. PCB board layout and schematics and gerber files are available on the NXP website <http://www.nxp.com/HV-INVERTER>.

It is your responsibility to obtain the additional inverter components. These components include the IGBT module, link capacitor, bus bar, cooling plate, mounting hardware, etc. You can design, select and assemble your own components and use the NXP PCBs to complete a PIM. As a service to our customers, a complete pre-assembled reference PIM platform is available through our partner Vepco Technologies. The IGBT module is available from our partner Fuji Electric.

### 3.2 EV-INVERTER enablement kit features

#### Benefits:

- Increases speed of development
- Full platform solution
- Provides functional safety options
- Optimizes performance

#### Featured products:

- GD3100 isolated IGBT ASIL-D gate driver
- MPC5775E advanced motor control ASIL-D MCU
- FS65XX robust ASIL-D SBC
- TJA1042 redundant CAN bus interface
- Capability to connect to Fuji M653 IGBT module for three-phase evaluations



3.3 EV-INVERTER Enablement kit block diagram

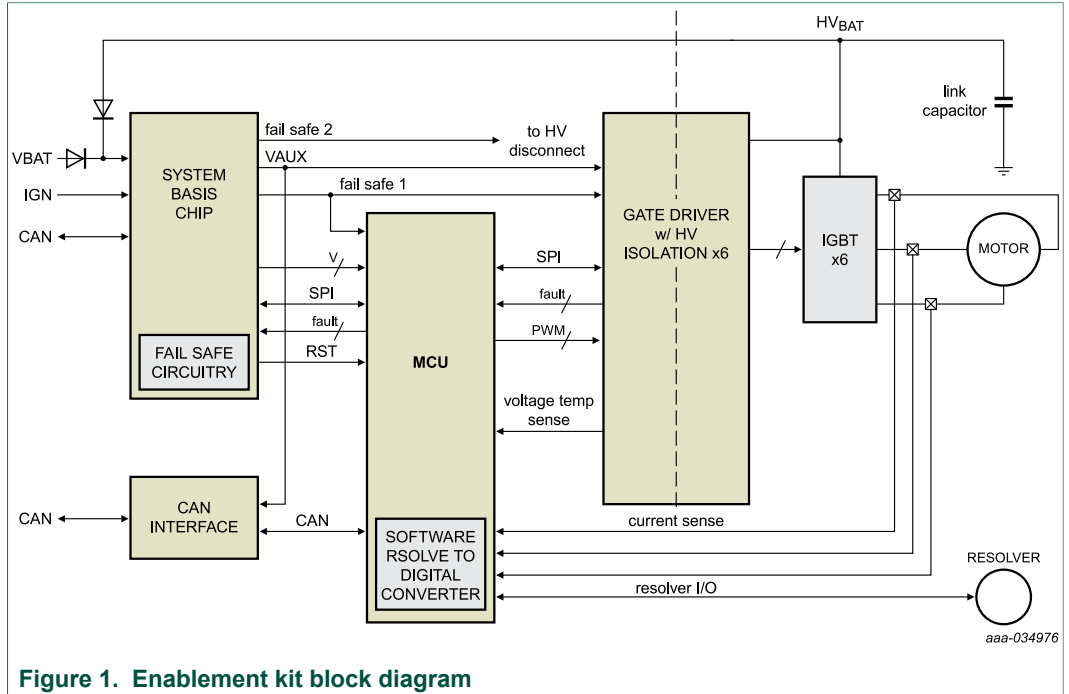

Figure 1. Enablement kit block diagram

3.4 Board descriptions

3.4.1 EV-CONTROLEVM board connectors

The center of the PIM unit is the controller board. This section describes the internal signals connecting to the control board. An MPC5775E is shown in Figure 2.

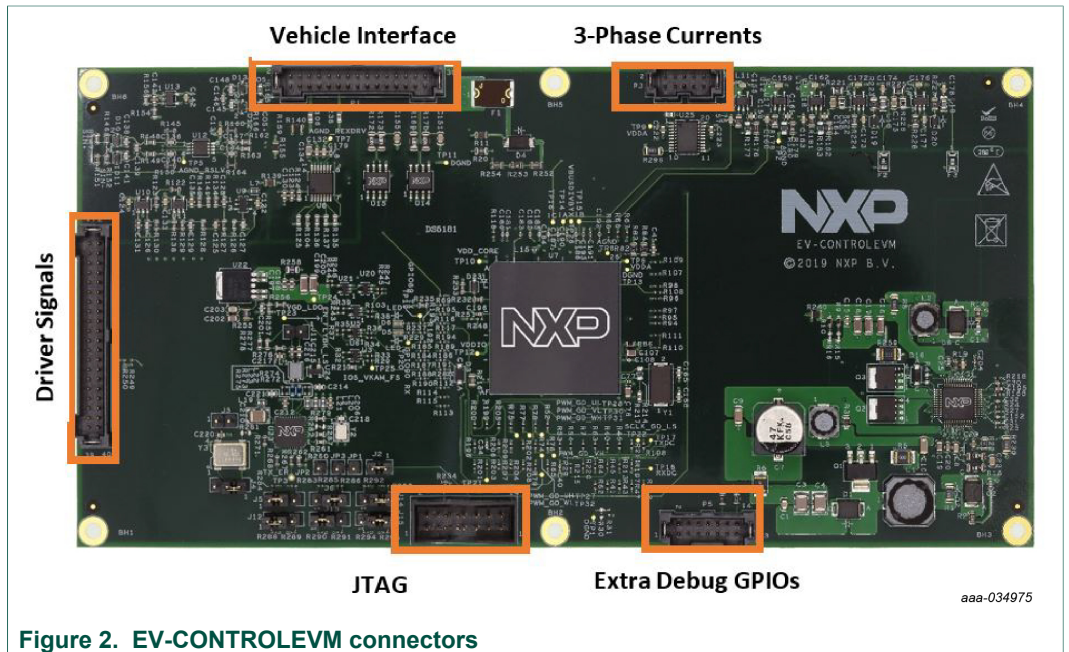

Figure 2. EV-CONTROLEVM connectors

## 3.4.1.1 Vehicle Interface connector pinout

Table 1. Vehicle interface 30-pin connector definitions

Connector: Samtec 2 mm, 2 x 15

Pin	Function	Type	Range	Memo
1	Resolver COS_P	Analog Input	0 to 5 V	2.5 V Centered; differential sig. +
2	Resolver COS_N	Analog Input	0 to 5 V	2.5 V Centered; differential sig. –
3	Resolver SIN_P	Analog Input	0 to 5 V	2.5 V Centered; differential sig. +
4	Resolver COS_P	Analog Input	0 to 5 V	2.5 V Centered; differential sig. –
5	Resolver Shield	AGND	—	—
6	Resolver Shield	AGND	—	—
7	Resolver VREX_P	Analog Output	0 to 5 V	Excitation; differential sig. +
8	Resolver VREX_N	Analog Output	0 to 5 V	Excitation; differential sig. –
9	RTD_RTN	AGND	—	—
10	RTD2_Sig	Resistive Input	0 to ∞ ohm	1 k RTD expected
11	RTD_RTN	—	—	—
12	RTD1_Sig	Resistive Input	0 to ∞ ohm	1 k RTD expected
13	CANB_L	Digital IO	0 to 5 V	—
14	CANB_H	Digital IO	0 to 5 V	—
15	GND_12V_RTN	—	—	—
16	GND_12V_RTN	—	—	—
17	NC	—	—	For clearance
18	NC	—	—	For clearance
19	12 V	Power	8 to 16 V	—
20	12 V	Power	8 to 16 V	—
21	NC	—	—	For clearance
22	NC	—	—	For clearance
23	IGNITION	Digital Input	0 to 16 V	Threshold 4.5 V
24	CANF_H	Digital IO	0 to 5 V	—
25	FS_IND	Digital Output	0 to 5 V	Fault Indicator
26	CANF_L	Digital IO	0 to 5 V	—
27	DGND	DGND	—	—
28	CANA_H	Digital IO	0 to 5 V	—
29	DGND	DGND	—	—
30	CANA_L	Digital IO	0 to 5 V	—

## 3.4.1.2 Driver signals connector pinout

Table 2. Driver signals 40-pin connector definitions

Connector: Samtec 2 mm, 2 x 20

Pin	Function	Type	Range	Memo
1	12 V	Power	8 to 16 V	Bypass
2	12 V	Power	8 to 16 V	Bypass
3	NC	NC	—	For clearance
4	NC	—	—	—
5	GND_12V_RTN	—	—	—
6	GND_12V_RTN	—	—	—
7	SCLK_GD_HS	Digital output	0 to 5 V	SPI_HS clock
8	DGND	—	—	—
9	MISO_GD_HS	Digital input	0 to 5 V	SPI_HS MISO
10	SCLK_GD_LS	Digital output	0 to 5 V	SPI_LS Clock
11	MOSI_GD_HS	Digital output	0 to 5 V	SPI_HS MOSI
12	MISO_GD_LS	Digital input	0 to 5 V	SPI_LS MISO
13	CS_HS	Digital output	0 to 5 V	SPI_HS CS
14	MOSI_GD_LS	Digital output	0 to 5 V	SPI_LS MOSI
15	FSS_HS	Digital output	0 to 5 V	Fail safe state high-side; active low
16	CS_GD_LS	Digital output	0 to 5 V	SPI_LS CS
17	EN_FLYBK_HS	Digital output	0 to 5 V	Enables flyback for high side
18	EN_FLYBK_LS	Digital output	0 to 5 V	Enables flyback for low side
19	VDDA	Power	5 V	Analog supply for Vdc measurement
20	FSENB	Digital output	0 to 5 V	Enables safe state; active low
21	VbusDivByX	Analog input	0 to 5 V	Bus voltage measurement
22	FSS_LS	—	—	Fail-safe state low side; active low
23	AGND	—	—	—
24	VGD_LDO	Power	5 V	Power supply for LS Logic
25	INTB_GD_HS	Digital input	0 to 5 V	Fault Indicator HS
26	INTB_GD_LS	Digital input	0 to 5 V	Fault Indicator LS
27	DGND	—	—	—
28	VDDIO	Power	5 V	Power supply for HS Logic
29	AOUT_UH	Digital input	0 to 5 V	—
30	AOUT_UL	Digital input	0 to 5 V	—
31	AOUT_VH	Digital input	0 to 5 V	—
32	AOUT_VL	Digital input	0 to 5 V	—
33	AOUT_WH	Digital input	0 to 5 V	—
34	AOUT_WL	Digital input	0 to 5 V	—

Pin	Function	Type	Range	Memo
35	PWM_UH	Digital output	0 to 5 V	—
36	PWM_UL	Digital output	0 to 5 V	—
37	PWM_VH	Digital output	0 to 5 V	—
38	PWM_VL	Digital output	0 to 5 V	—
39	PWM_WH	Digital output	0 to 5 V	—
40	PWM_WL	Digital output	0 to 5 V	—

### 3.4.1.3 Phase currents connector pinout

**Table 3. Phase currents 10-pin connector definitions**

Connector: Samtec 2 mm, 2 x 5

Pin	Function	Type	Range	Memo
1, 2	SHLD_GND	AGND	0	—
4, 6	VDDA	Power	5 V	50 mA max
3	VMID	Analog Input	0 to 5 V	Mid point of the supply voltage
5	Ia	Analog Input	0 to 5 V	—
7	Ib	Analog Input	0 to 5 V	—
9	Ic	Analog Input	0 to 5 V	—
8, 10	AGND	AGND	—	—

### 3.4.1.4 Phase extra debug GPIOs connector pinout

**Table 4. Phase extra debug GPIOs 14-pin connector definitions**

Connector: Samtec 2 mm, 2 x 7

Pin	Function	Type	Range	Memo
1, 3, 5, 7, 9	AGND			
2, 4, 6	Extra Digital IO	Digital IO	0 to 5 V	
8, 10, 12	Extra Analog Inputs	Analog Input	0 to 5 V	
11	IL_N	Resistive Input	0 to ∞ ohm	Loop back from IL_P
12	IL_P	Resistive Input	0 to ∞ ohm	

### 3.4.1.5 JTAG connector pinout

JTAG connector is compatible with PE Micro Multilink Debugger 0.1' 2x7 connector. Implemented signals as shown:

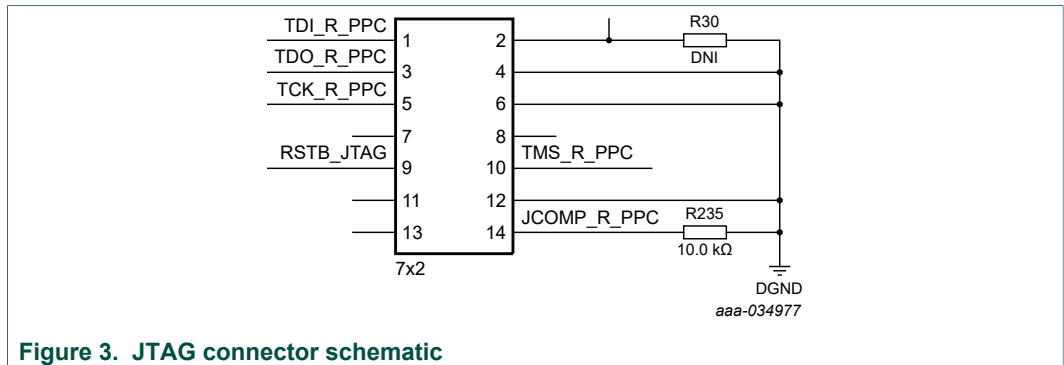

Figure 3. JTAG connector schematic

Table 5. Phase extra debug GPIOs 14-pin connector definitions

Connector: Samtec 2 mm, 2 x 7

Pin	Function	Type	Range	Memo
1	TDI_R_PPC			
2				Puts SBC input Debug mode upon power up
3	TDO_R_PPC			
4				
5				
6				
7				
8				
9	RSTB_JTAG			
10	TMS_R_PPC			
11				
12				
13				
14	JCOMP_R_PPC			

3.4.2 EV-POWERVEB board connector

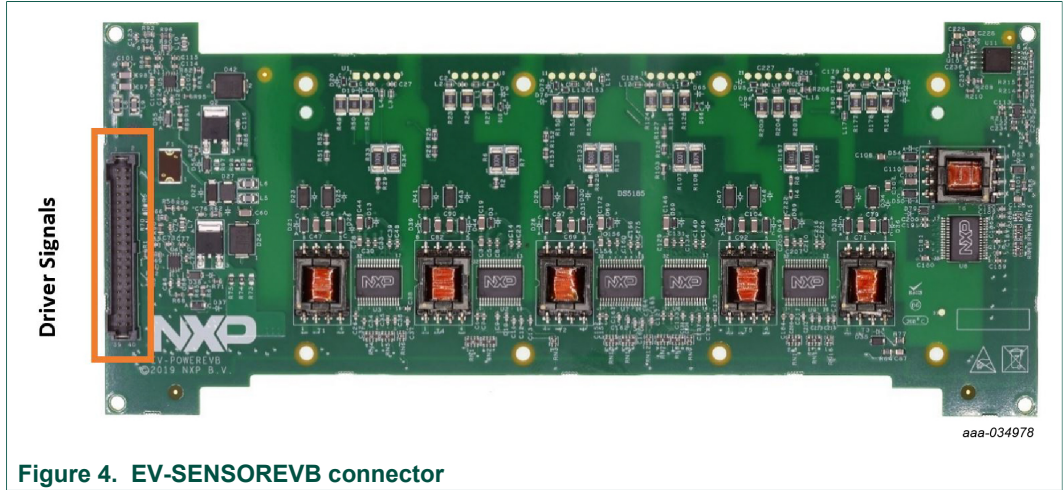

Figure 4. EV-SENSOREVB connector

3.4.2.1 Driver signals connector pinout

Table 6. Driver signals 40-pin connector definitions

Connector: Samtec 2 mm, 2 x 20

Pin	Function	Type	Range	Memo
1	12 V	Power	8 to 16 V	Bypass
2	12 V	Power	8 to 16 V	Bypass
3	NC	NC	—	For clearance
4	NC	—	—	—
5	GND_12V_RTN	—	—	—
6	GND_12V_RTN	—	—	—
7	SCLK_GD_HS	Digital output	0 to 5 V	SPI_HS clock
8	DGND	—	—	—
9	MISO_GD_HS	Digital input	0 to 5 V	SPI_HS MISO
10	SCLK_GD_LS	Digital output	0 to 5 V	SPI_LS Clock
11	MOSI_GD_HS	Digital output	0 to 5 V	SPI_HS MOSI
12	MISO_GD_LS	Digital input	0 to 5 V	SPI_LS MISO
13	CS_HS	Digital output	0 to 5 V	SPI_HS CS
14	MOSI_GD_LS	Digital output	0 to 5 V	SPI_LS MOSI
15	FSS_HS	Digital output	0 to 5 V	Fail-safe state high side; active low
16	CS_GD_LS	Digital output	0 to 5 V	SPI_LS CS
17	EN_FLYBK_HS	Digital output	0 to 5 V	Enables flyback for high side
18	EN_FLYBK_LS	Digital output	0 to 5 V	Enables flyback for low side
19	VDDA	Power	5 V	Analog supply for Vdc measurement
20	FSENB	Digital output	0 to 5 V	Enables safe state; active low
21	VbusDivByX	Analog Input	0 to 5 V	Bus voltage measurement



Pin	Function	Type	Range	Memo
22	FSS_LS	—	—	Fail-safe state low side; active Low
23	AGND	—	—	—
24	VGD_LDO	Power	5 V	Power supply for LS logic
25	INTB_GD_HS	Digital input	0 to 5 V	Fault indicator HS
26	INTB_GD_LS	Digital input	0 to 5 V	Fault indicator LS
27	DGND	—	—	—
28	VDDIO	Power	5 V	Power supply for HS Logic
29	AOUT_UH	Digital input	0 to 5 V	—
30	AOUT_UL	Digital input	0 to 5 V	—
31	AOUT_VH	Digital input	0 to 5 V	—
32	AOUT_VL	Digital input	0 to 5 V	—
33	AOUT_WH	Digital input	0 to 5 V	—
34	AOUT_WL	Digital input	0 to 5 V	—
35	PWM_UH	Digital output	0 to 5 V	—
36	PWM_UL	Digital output	0 to 5 V	—
37	PWM_VH	Digital output	0 to 5 V	—
38	PWM_VL	Digital output	0 to 5 V	—
39	PWM_WH	Digital output	0 to 5 V	—
40	PWM_WL	Digital output	0 to 5 V	—

3.4.3 EV-SENSOREVB board connectors

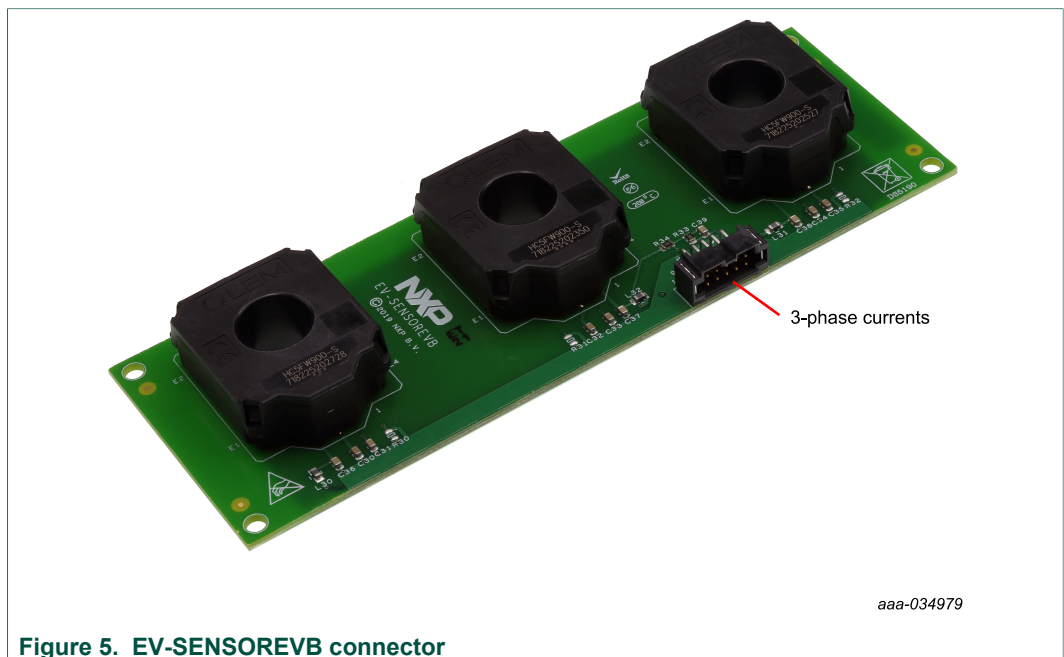

Figure 5. EV-SENSOREVB connector

3.4.3.1 EV-SENSOREVB connector pinout

Table 7. Phase currents 10-pin connector definitions

Connector: Samtec 2 mm, 2 x 5

Pin	Function	Type	Range	Memo
1, 2	SHLD_GND	AGND	0	—
4, 6	VDDA	Power	5 V	50 mA max
3	VMID	Analog Input	0 to 5 V	Mid point of the supply voltage
5	Ia	Analog Input	0 to 5 V	—
7	Ib	Analog Input	0 to 5 V	—
9	Ic	Analog Input	0 to 5 V	—
8, 10	AGND	AGND	—	—

3.4.4 EV-INTERFACEVB board connectors

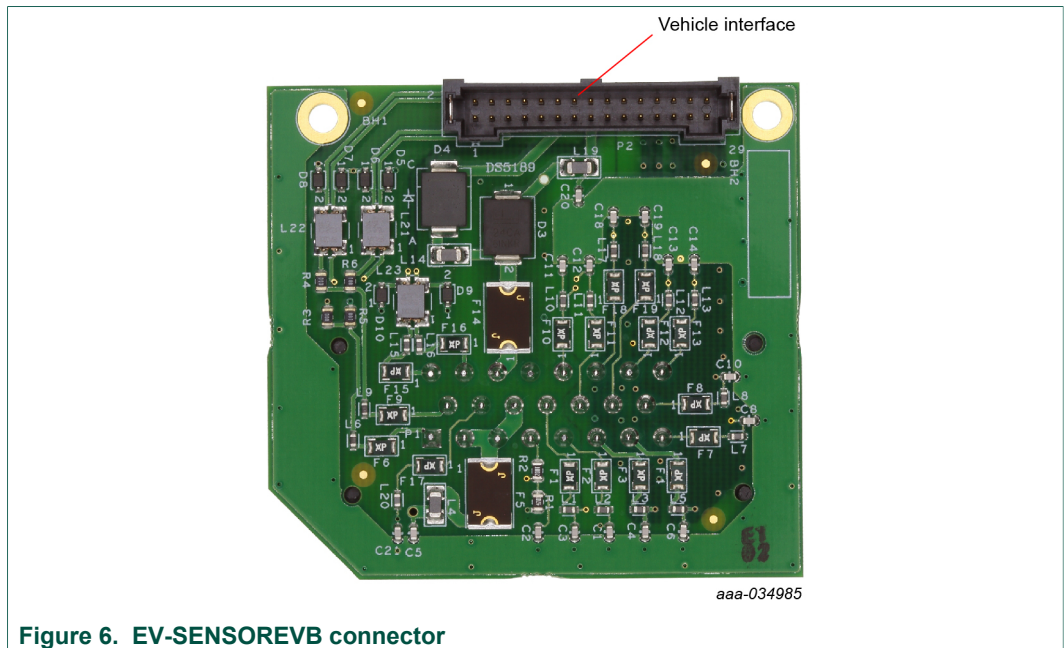

Pin	Function	Type	Range	Memo
7	Resolver VREX_P	Analog Output	0 to 5 V	Excitation; differential sig. +
8	Resolver VREX_N	Analog Output	0 to 5 V	Excitation; differential sig. –
9	RTD_RTN	AGND	—	—
10	RTD2_Sig	Resistive Input	0 to $\infty$ ohm	1k RTD expected
11	RTD_RTN	—	—	—
12	RTD1_Sig	Resistive Input	0 to $\infty$ ohm	1k RTD expected
13	CANB_L	Digital IO	0 to 5 V	—
14	CANB_H	Digital IO	0 to 5 V	—
15	GND_12V_RTN	—	—	—
16	GND_12V_RTN	—	—	—
17	NC	—	—	For clearance
18	NC	—	—	For clearance
19	12V	Power	8 to 16 V	—
20	12V	Power	8 to 16 V	—
21	NC	—	—	For clearance
22	NC	—	—	For clearance
23	IGNITION	Digital Input	0 to 16 V	Threshold 4.5 V
24	CANF_H	Digital IO	0 to 5 V	—
25	FS_IND	Digital Output	0 to 5 V	Fault Indicator
26	CANF_L	Digital IO	0 to 5 V	—
27	DGND	DGND	—	—
28	CANA_H	Digital IO	0 to 5 V	—
29	DGND	DGND	—	—
30	CANA_L	Digital IO	0 to 5 V	—

## 4 Assembling the hardware

The following hardware, described in [Section 3 "Getting to know the hardware"](#), is required to build an inverter assembly.

- The enablement kit (EV-INVERTER)
- Fuji IGBT M653 Module
- Cooling plate
- DC link capacitor
- Bus bar
- High-voltage cabling for inverter supply (2-wire)
- High-voltage cabling for motor connection (3-wire)
- 23-position signal connector
- Mounting hardware
- 12 V power supply (inverter)

- High-voltage power supply (motor)
- CAN Interface link
- Motor

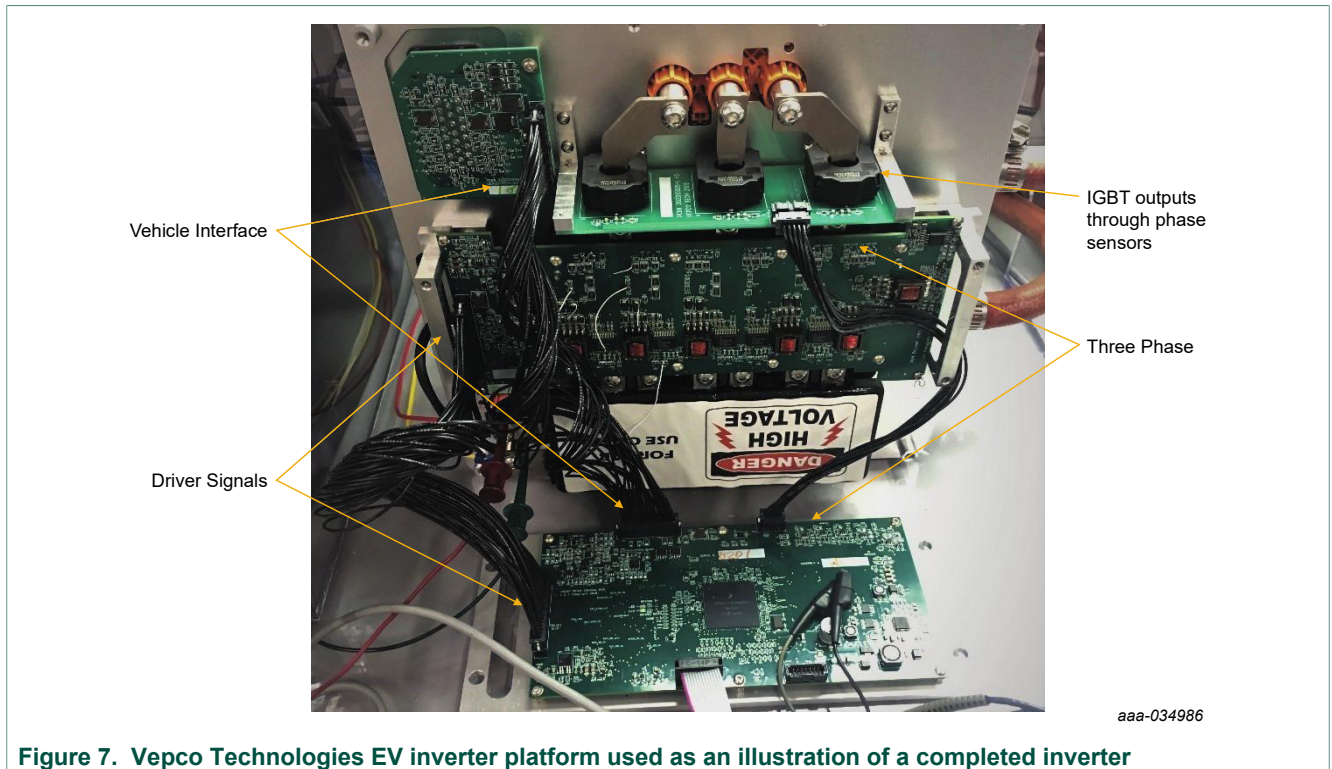

Figure 7. Vepeco Technologies EV inverter platform used as an illustration of a completed inverter

1. Attach the IGBT module to the cooling plate.
2. Attach the DC link capacitor tabs to the IGBT terminals.
3. Attach the EV-POWЕРЕVB to the IGBT module. Ensure that all board socket connection pins are properly seated onto the IGBT pin connections. Fasten the gate driver board to the IGBT with screws and other hardware for a secure fitment.
4. Connect the 3-phase motor cable to the IGBT module, ensuring the U, V, and W connections match. If available, latch the handle to ensure a secure connection.
5. For running a motor in a closed loop motor control, connect the EV-SENSOREVB board to the EV-CONTROLEVM with the 10-pin harness. See [Figure 8](#).
6. Connect the EV-POWЕРЕVB to the EV-CONTROLEVM with the 40-pin harness. See [Figure 8](#).
7. Connect the EV-INTERFACEVB to the EV-CONTROLEVM with the 30-pin harness. See [Figure 8](#).
8. Connect the low-voltage DC power supply (12 V) to the EV-CONTROLEVM board.
9. Connect the high voltage/high current DC supply positive and negative connections (2-wire) to the DC Link capacitor to supply high voltage to the IGBT and motor.
  - a. Before applying high voltage (>300 V) to the DC connection, use a current limited (1 A) power supply and apply 15 to 30 V to the DC to make sure there is no excessive leakage current.
  - b. Unlatch the handle, insert the cable assembly to the header and relatch the handle for a secure connection.
10. Connect the EXT\_DGND to 12 V GND.
11. Open the PIM by removing the plastic protection cover.

12. Connect the 14-pin debugger header on the EV-CONTROLEVM with pin 1 mark aligned.
13. Connect the PEMicro Multilink to the host PC. Both led lights on the PEMicro Multilink should be on, indicating that the CAN bus is live and ready to communicate.

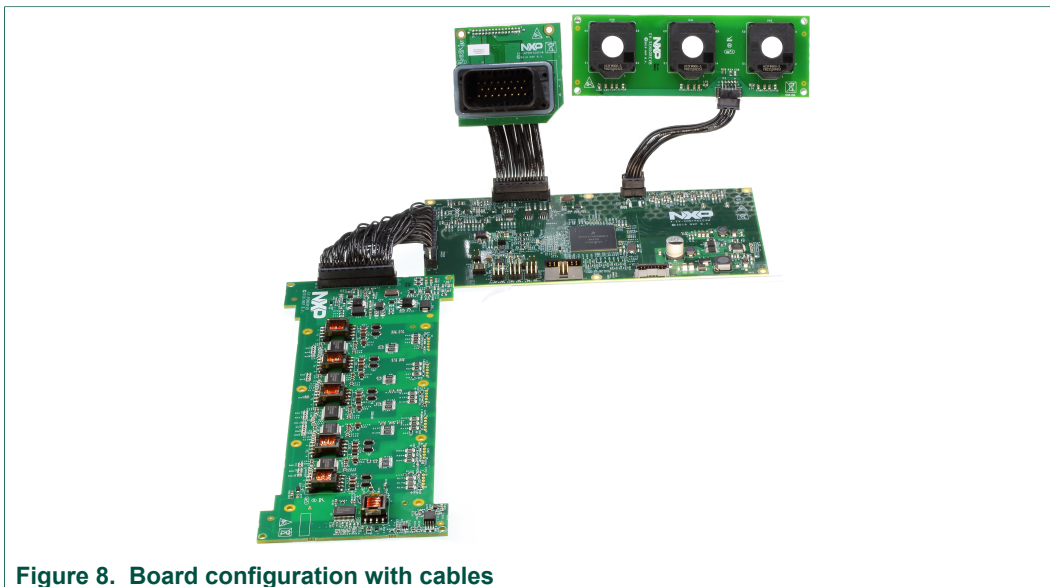

Figure 8. Board configuration with cables

#### 4.1 Using a motor not from Vepco Tehnologies

The application software in the PIM was developed for a 4-pole pair, 3-phase permanent magnet synchronous motor. The PIM expects a 4-lobe 6-wire position resolver sensor to provide the rotor position information. If the custom motor is the same configuration, then the speed and position information in the software are correct.

In the case of a different number of pole pair or resolver configuration, it is necessary to reconfigure or rewrite the PCS.c API void `Get_RotorPos(T_S16* Pos)` to calculate the position (0 to 4095) based on the resolver configuration.

The connectors shown in [Figure 9](#) and [Figure 10](#) are used to bring in signals from CAN, resolver, and motor.

Please note that depending on how the motor is wound the positive direction of the motor may be different from the definition from the PIM.

- **Calibration table**

It is often required to use a custom motor table for optimization. The format of the table is presented in `LookupTable.c`. The lookup tables are two-dimensional (2D) tables. These tables request torque (`Tq_cmd`) and rpm/Vdc ratio (`rpm_Vdc`) inputs. The outputs are `Id`, `Iq`, `Ld`, `Lq`, and `Lambda`; each output having its own table.

It is possible to bypass the lookup tables by operating the motor in the `Id Iq` reference mode instead of Torque reference mode.

- **Faults and Warnings**

The faults and warnings are handled in the FTM module. A few examples are provided in the module.

- **Speed mode**

The speed reference mode is implemented as an outer loop of the torque reference mode. Depending on the inertia and other characteristics of the motor, it may require

some tuning to the speed loop parameters. These parameters can be found in the MSC module.

23-position signal connector Ampseal® PN 770680-1



Figure 9. EV-INTERFACEVB connections

The EV-Interface 23 pin connector is used to bring in signals from the CAN, resolver, and motor. The 23-position signal connector on the backside of the EV-INTERFACEVB connections are described in [Table 9](#).

1. Unlatch the handle, insert the cable assembly into the header and relatch the handle.
  - Note:** depending on how the motor is wound the positive direction of the motor may be different from the definition from the PIM.
2. The PIM rB is preloaded with demo software that does not require motor signals to be connected. The demo software runs open-loop controls once the logic power is supplied.
3. The following are required connections for the demo software:
  - Ground: EXT\_DGND must be connected to 12 V GND
  - Power supply: unswitched 12 V and ignition may be tied together.
  - In the supplied harness, the red/white wire is connected to the supply. The red-black/white-black is connected to the logic ground.



aaa-035154

Figure 10. EV-INTERFACEVB connections



Table 9. EV-INTERFACEVB connections

Pin	Name	Description	Value
1	EXT_CANH_A	CANA Low	TTL 0 to 5 V
2	EXT_DGND	Digital Ground	0 V, 100 mA
3	EXT_DGND	Digital Ground	0 V, 100 mA
4	EXT_12V_IGNIT	Ignition	0 to 16 V, 100 mA
5	EXT_MTRTD1_RTN	Motor RTD 1 Return	Resistor –
6	EXT_RSLVR_DRV_SHIELD	Resolver Excitation Shield	0 V
7	EXT_RSLVR_SNS_SHIELD	Resolver Sense Shield	0 V
8	EXT_RSLVR_S1	Resolver sense S1	Analog 100 mA
9	EXT_CANL_A	CANA High	TTL 0 to 5 V
10	EXT_FLT_OUT	Fsb1	TTL
11	NC	—	—
12	EXT_MTRRTD1_SIG	Motor RTD 1 Signal	Resistor +
13	EXT_MTRRTD2_SIG	Motor RTD 2 Signal	Resistor +
14	EXT_RSLVR_R1	Resolver excitation R1	Analog 100 mA
15	EXT_RSLVR_S3	Resolver sense S3	Analog 100 mA
16	NC	—	—
17	NC	—	—
18	EXT_12V_UNSWTCHD	Unswitched 12 V	10 to 16 V, 2 A
19	EXT_12V_RETURN_GND	12 V GND	0 V, 2 A
20	EXT_MTRRTD2_RTN	Motor RTD 2 Return	Resistor –
21	EXT_RSLVR_R2	Resolver excitation R2	Analog 100 mA
22	EXT_RSLVR_S2	Resolver sense S2	Analog 100 mA
23	EXT_RSLVR_S4	Resolver sense S4	Analog 100 mA

Connecting CANA\_H to CANA\_L in the supplied harness is optional. The green wire is CANH and the green-black wire is CANL. Refer to [Table 10](#) for connections. For advanced operation of the PIM, it is required to have a motor with a resolver and RTD temperature sensing connections. Connect CANA\_H CANA\_L Resolver signals to x6 RTD1 signals x2 for proper operation of the PIM.

Table 10. Optional connections

PCB	Device	Color	Molex 33472-1206
P1	RTD1 +	RD	1
P2	RTD –	RD-BK	2
P3	RTD2 +	YL	3
P4	RTD2 –	YL-BK	4
P10	RSLV S1	BL	7
P6	RSLV S3	BL-BK	8
P5	RSLV S2	GN	9

PCB	Device	Color	Molex 33472-1206
P9	RSLV S4	GN-BK	10
P8	RSLV R1	WT	11
P7	RSLV R2	WT-BK	12
n.a.	n.a.	n.a.	5
n.a.	n.a.	n.a.	6

## 5 Software requirements and installation

Table 11. Software descriptions

Name	Source	Use
S32 Design Studio for Power Architecture 2017.R1	<a href="http://nxp.com">nxp.com</a>	Debugger toolchain
Ginkgo CAN-USB driver set		GUI toolchain
Python 3.6, 32-bit		GUI toolchain
Pyqt5 (supporting package for the Gui)		GUI toolchain
Csv (supporting package for the Gui)		GUI toolchain

### 5.1 S32 Design Studio for Power Architecture 2017.R1

The S32 Design Studio IDE is a complimentary integrated development environment for Automotive and Ultra-Reliable MCUs that enables editing, compiling and debugging of designs.

1. Go to <https://www.nxp.com/design/software/embedded-software/s32-design-studio-ide/s32-design-studio-ide-for-power-architecture-based-mcus:S32DS-PA> and click **User Guide**.
2. Follow the instructions within the S32 Design Studio for Power Architecture 2.1 Installation Guide.
3. Run the S32 Design Studio by clicking the S32 Design Studio for Power Architecture Version 2017.R1 icon.
4. Click **Run > Flash from file...**
5. Double-click the **GDB PEmicro Interface Debugging** icon
6. Change the name of the new configuration to **MPC5775E**.

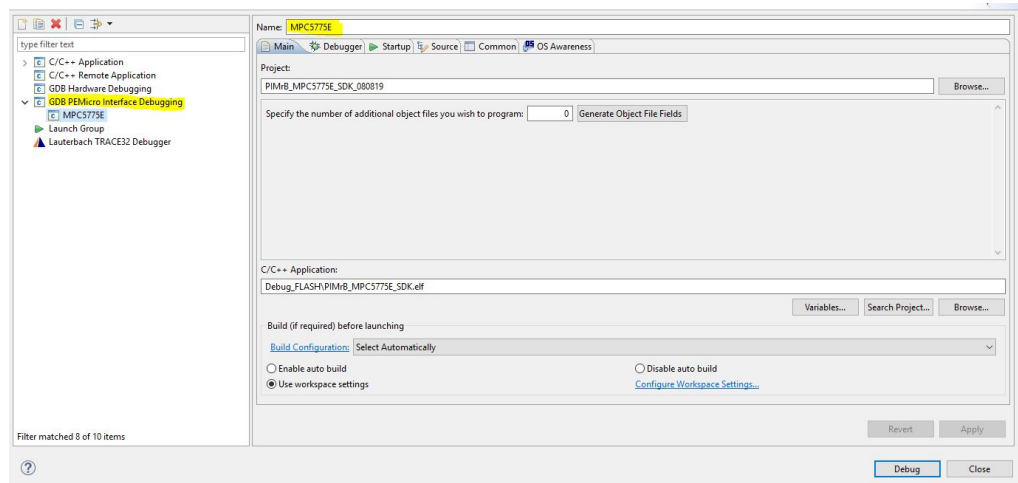

7. Click the **Debugger** tab

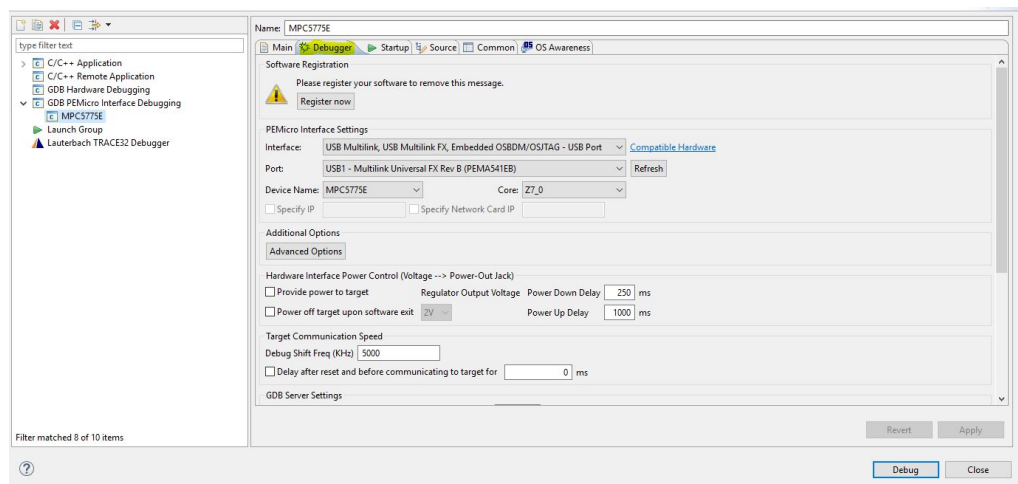

8. Click the **Device Name** drop-down menu and select **MPC5775E**

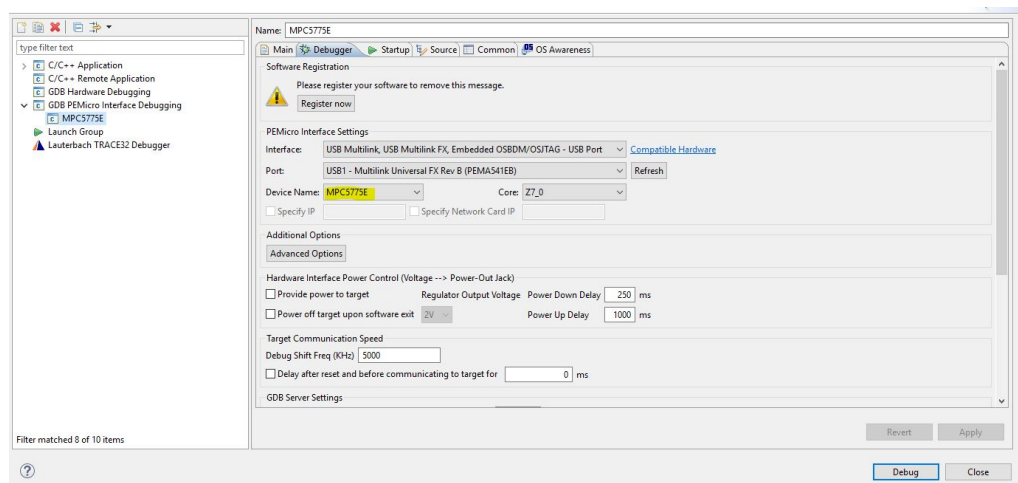

9. Click the **Advanced Options** button

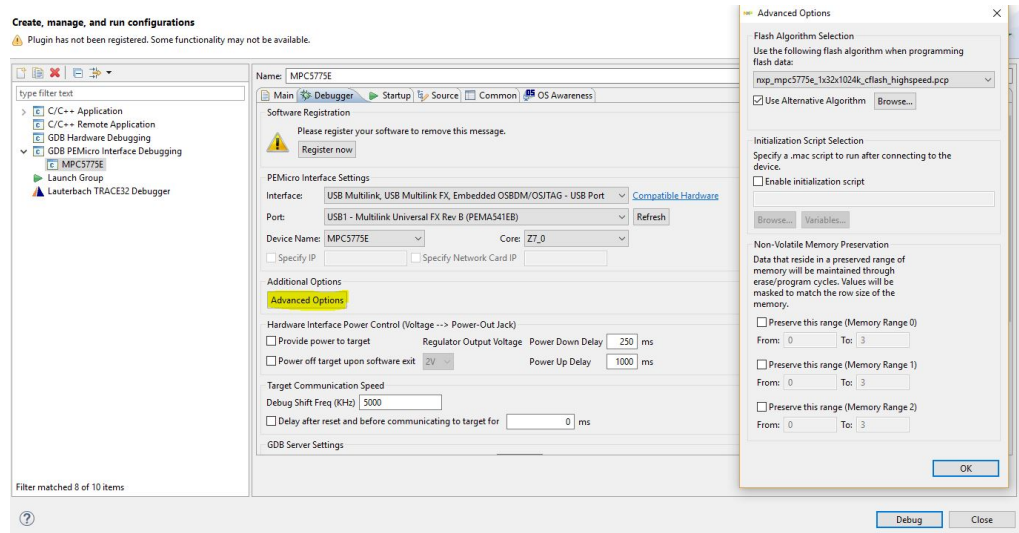

10. Under the **Flash Algorithm Selection**, check the **Use Alternative Algorithm** checkbox.

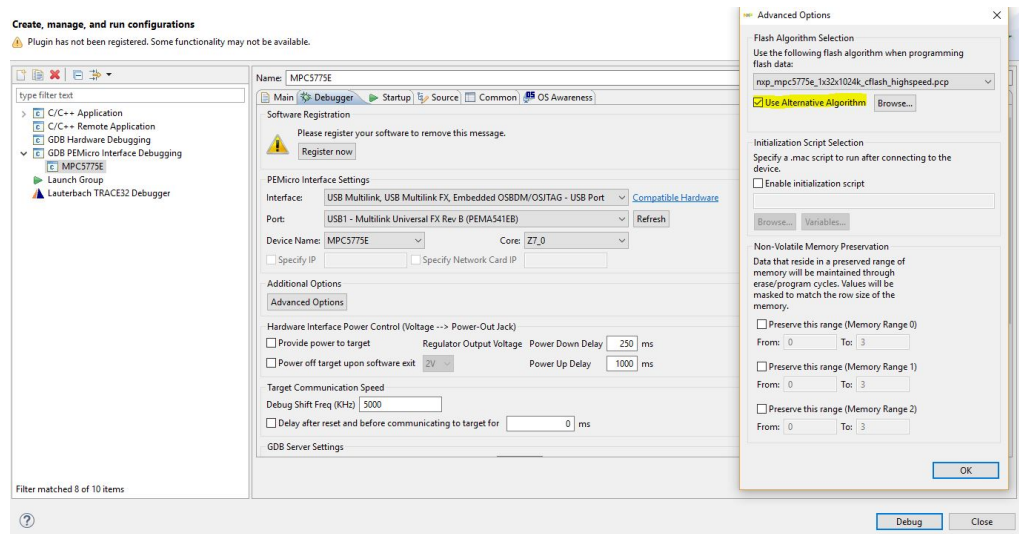

11. Browse to select **NXP\_MPC5775E\_1x32x64k\_EEPROM\_highspeed.pcp**

**Note** This file may reside in different locations, depending on the PE micro plugin installation. Search the file name under the Design Studio installation directory or PE micro installation directory to locate the .pcp file.

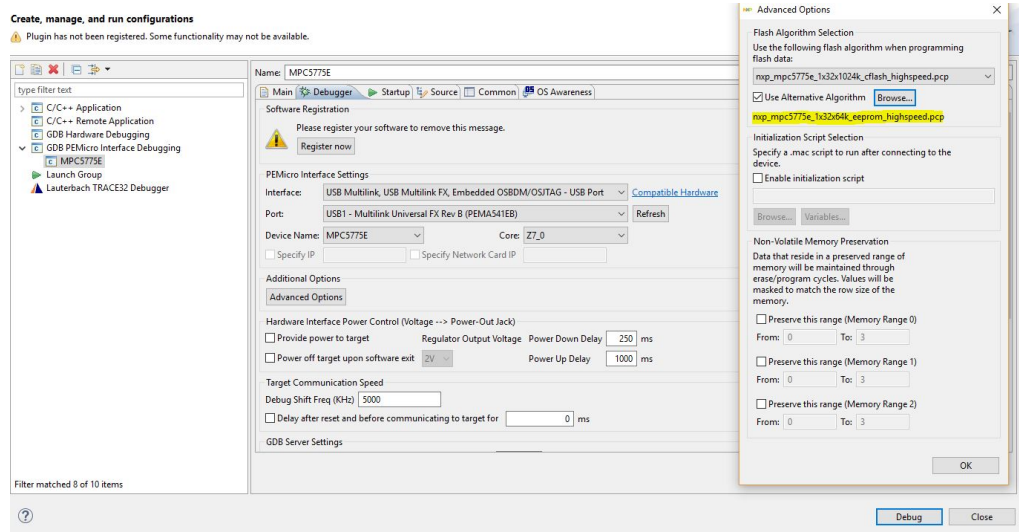

12. Flash the .elf file once.

13. Uncheck the **Use Alternative Algorithm** checkbox and flash the .elf a second time using the default flash algorithm for MPC5775E.

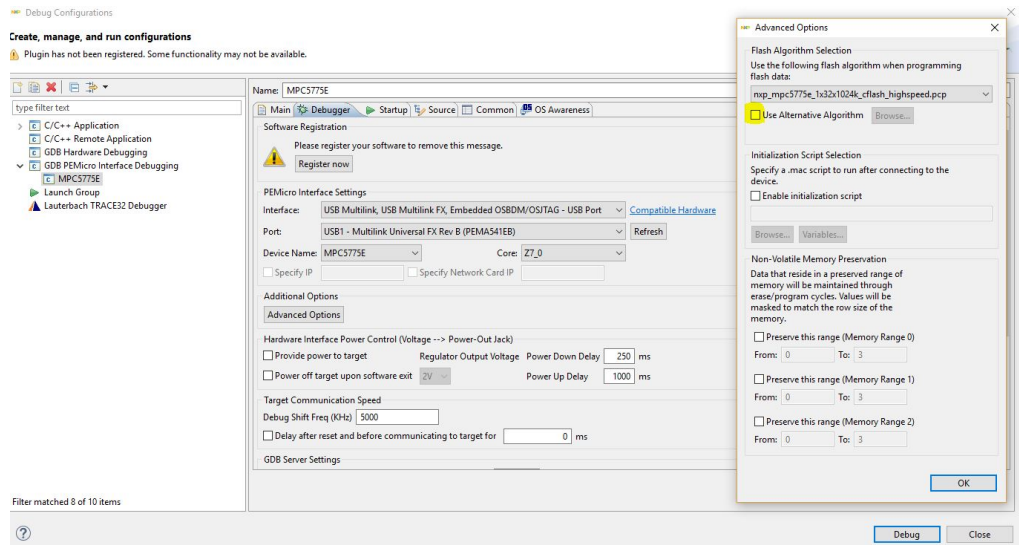

## 5.2 Installing the USB – CAN interface adapter

1. Browse to: <http://www.viewtool.com/index.php/en/20-2016-07-29-02-10-12-16-ginkgo-series-drivers>.
2. Download the v1.0.0 driver and install it. The driver page is shown in [#topic\\_b94d254c-c3f7-4e60-b3ab-263f1303d04c/fig\\_07659ffb-2fff-4376-a313-a77030033a83](#).

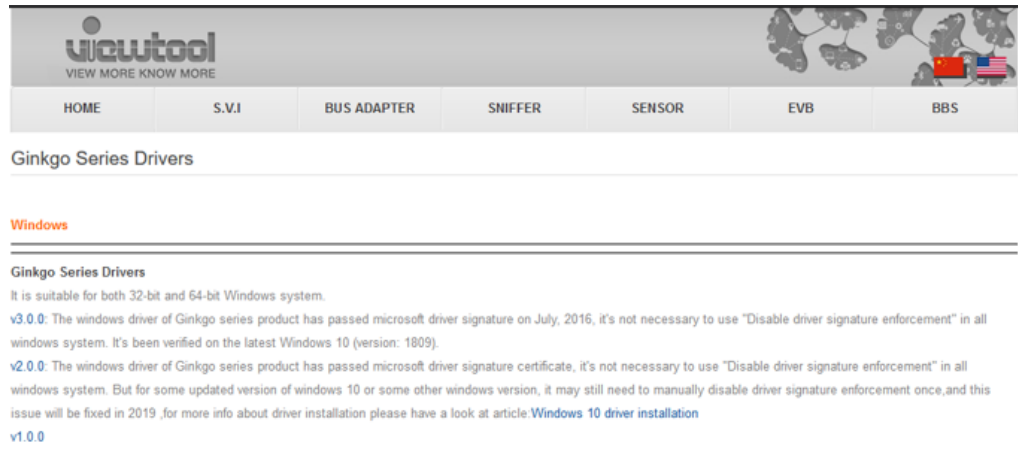

If the driver does not install correctly, please complete the following steps to boot Windows 10 in **Disable driver signature enforcement** mode and then install the driver.

3. Connect the USB-CAN Interface Adapter to a USB port on the computer.

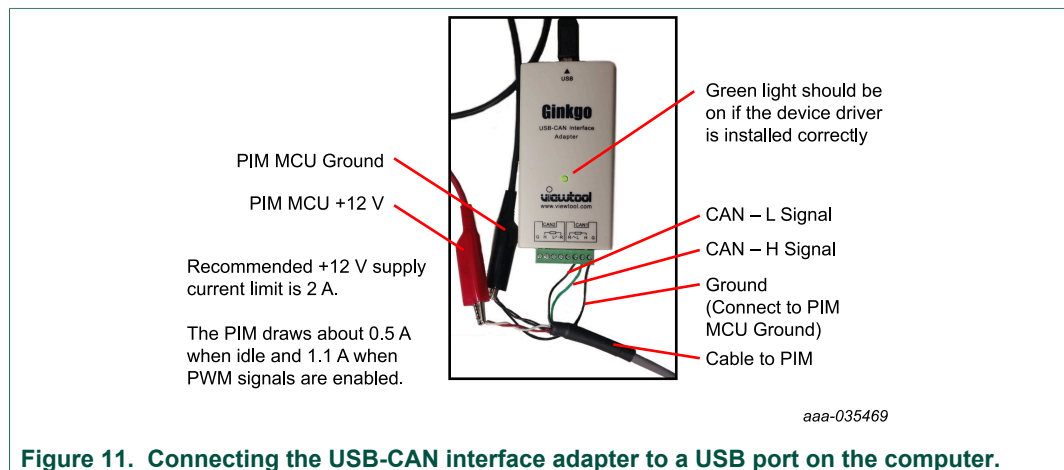

Figure 11. Connecting the USB-CAN interface adapter to a USB port on the computer.

### 5.2.1 Steps to disable the driver signature enforcement in Windows 10

1. Click the Windows Start button, then click the Settings gear icon.
2. Select **Update & Security**.
3. On the left, click the **Recovery** option.
4. Once selected, you will see an advanced startup section appear on the right hand side. You will need to click on the **Restart now** button.
5. Once your Computer has rebooted you will need to choose the **Troubleshoot** option.
6. Click **Advanced options**.
7. Click **Startup Settings**.
8. Because you are modifying the boot time configuration settings, you will need to restart your computer one last time.
9. Here you will be given a list of startup settings that you can change. Press the F7 key to choose the **Disable driver signature enforcement** setting.



### 5.3 Python setup

1. Download Python 3.6.8 from: <https://www.python.org/ftp/python/3.6.8/python-3.6.8.exe>
2. Run the installer and follow the prompts to install it.
3. Open a command window and navigate to the install directory. CD to the Scripts directory.
4. Install PYQT5 by typing "pip install pyqt5" and pressing **Enter**.

```
C:\Python36-32\Scripts>pip install pyqt5
Collecting pyqt5
  Using cached https://files.pythonhosted.org/packages/5a/6f/e2510c7d1183fbb41c11bf50b6c3248f5e3defc10326756a51321bea6f8/PyQt5-5.12.1-5.12.2-cp35-cp36-cp37-cp38-none-win32.whl
Collecting PyQt5_sip<4.20,>=4.19.14 (from pyqt5)
  Using cached https://files.pythonhosted.org/packages/79/8c/3fed3fb79a629a80544e5e0cc8467706a5fa1f56e3027e034d1530ca2e08/PyQt5_sip-4.19.15-cp36-none-win32.whl
Installing collected packages: PyQt5-sip, pyqt5
Successfully installed PyQt5-sip-4.19.15 pyqt5-5.12.1
You are using pip version 18.1, however version 19.0.3 is available.
You should consider upgrading via the 'python -m pip install --upgrade pip' command.
```

5. Install PYQTGraph by typing “pip install pyqtgraph” and pressing Enter.

```
C:\Python36-32\Scripts>pip install pyqtgraph
Collecting pyqtgraph
  Using cached https://files.pythonhosted.org/packages/cd/ad/307e0280df5c19986c4206d138ec3a8954afc722cea991f4adb4a16337d9/pyqtgraph-0.10.0.tar.gz
Collecting numpy (from pyqtgraph)
  Using cached https://files.pythonhosted.org/packages/b3/84/41c7af95bab850819bddbc13e3e10317dacd3e28e2a0a5f14d8dbdc1c725/numpy-1.16.2-cp36-cp36m-win32.whl
Installing collected packages: numpy, pyqtgraph
  Running setup.py install for pyqtgraph ... done
Successfully installed numpy-1.16.2 pyqtgraph-0.10.0
You are using pip version 18.1, however version 19.0.3 is available.
You should consider upgrading via the 'python -m pip install --upgrade pip' command.

C:\Python36-32\Scripts>
```

6. Download the PIM GUI using the following link: [https://nxp1.sharepoint.com/:u:/t/ext330/ETZLgn\\_fSy9HvOi46pMOEWEBX2AktvAtmQVSnhH8oqVy2gw?e=4:ECaWcy:origemail&at=9](https://nxp1.sharepoint.com/:u:/t/ext330/ETZLgn_fSy9HvOi46pMOEWEBX2AktvAtmQVSnhH8oqVy2gw?e=4:ECaWcy:origemail&at=9)
7. Unzip c55\_gui.zip to a folder that you want to run it from.
8. Right click on app\_mpc55term.py and select “Open with”.
9. Select “Choose another app”.
10. Scroll down and click on “More apps”

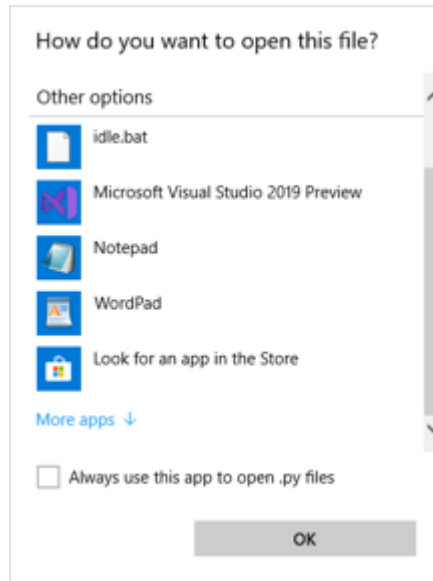

- 11.If Python is not shown, scroll down and click on “Look for another app on this PC”.
- 12.Navigate the Python.exe file that was installed earlier and select it.
- 13.Check the box labeled “Always use this app to open .py files” and click on OK.

### 5.4 Running the PIM GUI

1. Double click on app\_mpc55term.py to run the PIM GUI.
2. Click on CANBus → Connect to connect to the USB\_CAN interface adapter.
3. The GUI should now be connected to the PIM.

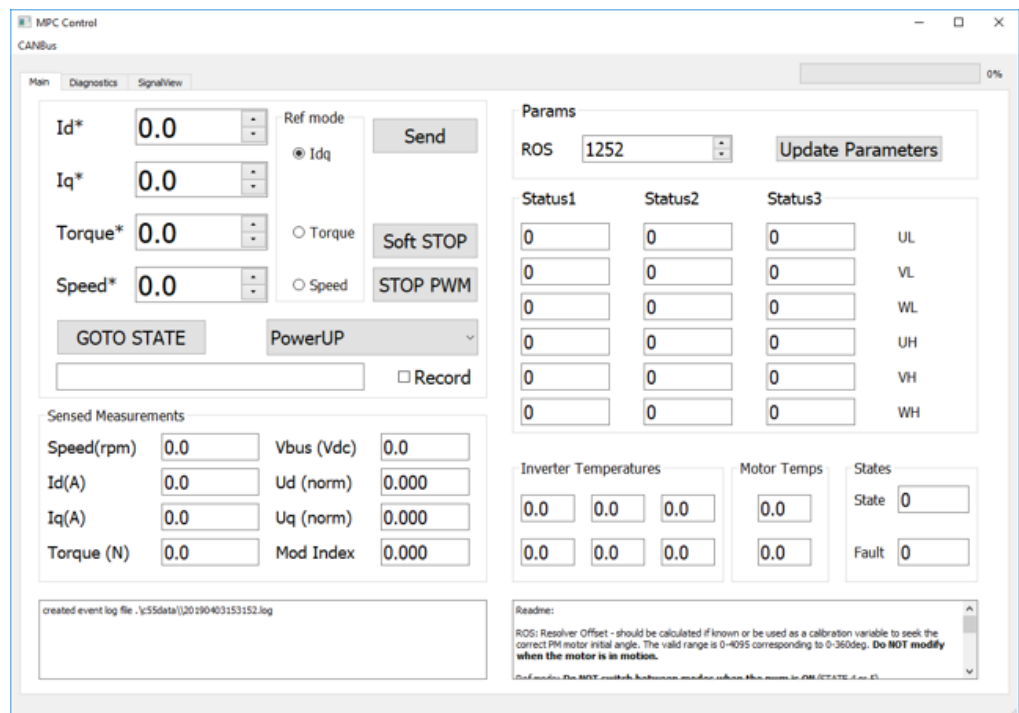

## 6 Operation of the Power Inverter Module (PIM)

After completing the steps in [Section 4 "Assembling the hardware"](#) and [Section 5 "Software requirements and installation"](#), you are now ready to operate the Power Inverter Module (PIM).

### 6.1 Demo software

1. The Inverter control board is preloaded with DEMO software that does not require motor signals to be connected. The Demo software is running open loop controls once the logic power is supplied.
2. Required connection for demo software:
  - Ground: EXT\_DGND must be connected to 12 V GND
  - Power Supply: Unswitched 12 V and Ignition may be tied together.
  - In the supplied harness, the red/white wire is connected to the supply. The red-blak/white-black is connected to the logic ground.
  - Optional connection:
    - CANA\_H CANA\_L
    - In the supplied harness, the green is CANH and green-black is the CANL.
    - Refer to [Table 10](#) for connection:
    - For advanced operation of PIM, it is required to have a motor with resolver and RTD temperature sensing connections: The following signals need to be connected for proper operation of the PIM.
      - CANA\_H CANA\_L
      - Resolver signals x6
      - RTD1 signals x2
3. Apply 30 Vdc on the TE DC connector
4. Apply 12 V logic power supply and observe the motor starting to slowly spin with a speed ramp up until it is stable

### 6.2 BSW software

1. Once the DC connection, Motor 3 phase connection and the signal connections are in place, turn on the logic power
2. Apply DC voltage (recommend or lower on the bench)
3. Start the Python based UI program named **app\_mpc55term.py**

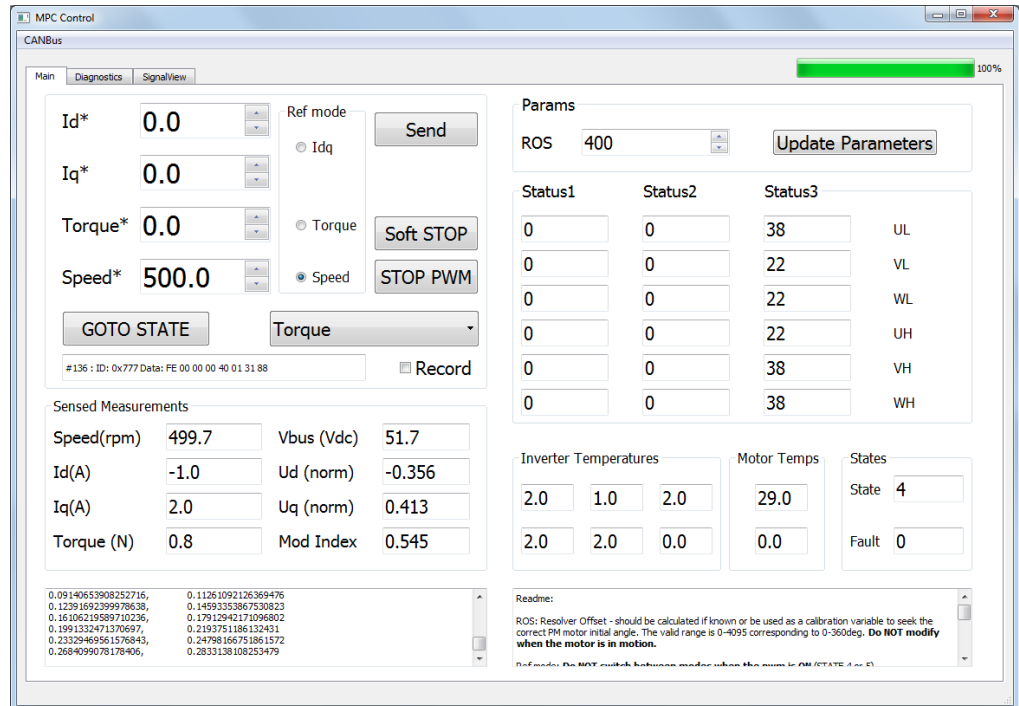

- Once started, click on the **CANBus > Connect** menu to initialize the CAN connection to the PIM.
- Once the CAN communication is established, Sensed Measurements, Inverter Temperatures and Motor Temps (only top one is implemented), States, GD Statuses are updated regularly.
- The motor parameters ROS is the initial angle of the resolver, its value should be predetermined or calibrated. The valid range is 0 to 4096 corresponding to 0 to 360°. The speed parameters are not implemented.

To enable the Pulse Width Modulation (PWM):

- Click the drop down menu and select Torque
- Click the GOTO STATE button
- Once in the Torque mode, select a desired reference mode and apply the proper command value
- Click Send button to execute the command

To stop, either by clicking the Soft STOP button to automatically reduce the commands to 0 but remain in the Torque mode; or, click the STOP PWM button to disable the PWM directly (equivalent to GOTO STATE PowerDown). The State display should change accordingly to the actual state the PIM is in. The numerical relationship between state text and state number is

**Table 12. Inverter control states**

Description	State number	Fault number
PowerUp	0	
Init	1	
SelfTest	2	
Ready	3	

Description	State number	Fault number
Torque	4	
LimitedOp	5	
Fault	6	
Discharge	7	
PowerDown	8	

During operation, the Status registers of each GD is read periodically. The values are in decimal format display.

In case of Fault, the current behavior is that the PIM will report the Fault number and stays in Fault mode until the next reset (by power cycle or debugger reset)

Faults and the fault codes In the current software are listed in [Table 13](#).

**Table 13. Fault codes**

Fault	Bit	Condition	PWM	Warning level
Over voltage	1	> 450 V	6 Off	400
Over current Ia	2	> 700 A	6 Off	500
Over current Ib	3	> 700 A	6 Off	500
Over current Ic	4	> 700 A	6 Off	500
MT Over temperature	5	120 °C	6 Off	110
GD INTB fault	6	GD INTB = 0	6 Off	any
IGBT OT	7	150 °C	6 Off	135
Scheduler	8	Over run	6 Off	any
Resolver fault	9	Init Fault	6 Off	any

Diagnostics:

Diagnostics functions are available to trace instantaneous values of key variables when fault occurs or when requested.

There are total 6 records stored in the RAM and FLASH. Record 0 is the Statistical Result. Current Record is the latest Signal results. Records 1 to 4 are the stored (in flash) the last 4 records.

### 6.3 Diagnostics

The records are either triggered by a fault condition except CurrentRecord, which can be triggered by Manual Trigger.

To retrieve the records, click the Grab Button. Then choose the desired signal after the record is 100% uploaded.

The record contains 64 data points each sampled at the 100uS task. When triggered by Fault, 50 data points are before the triggering, 14 are after.

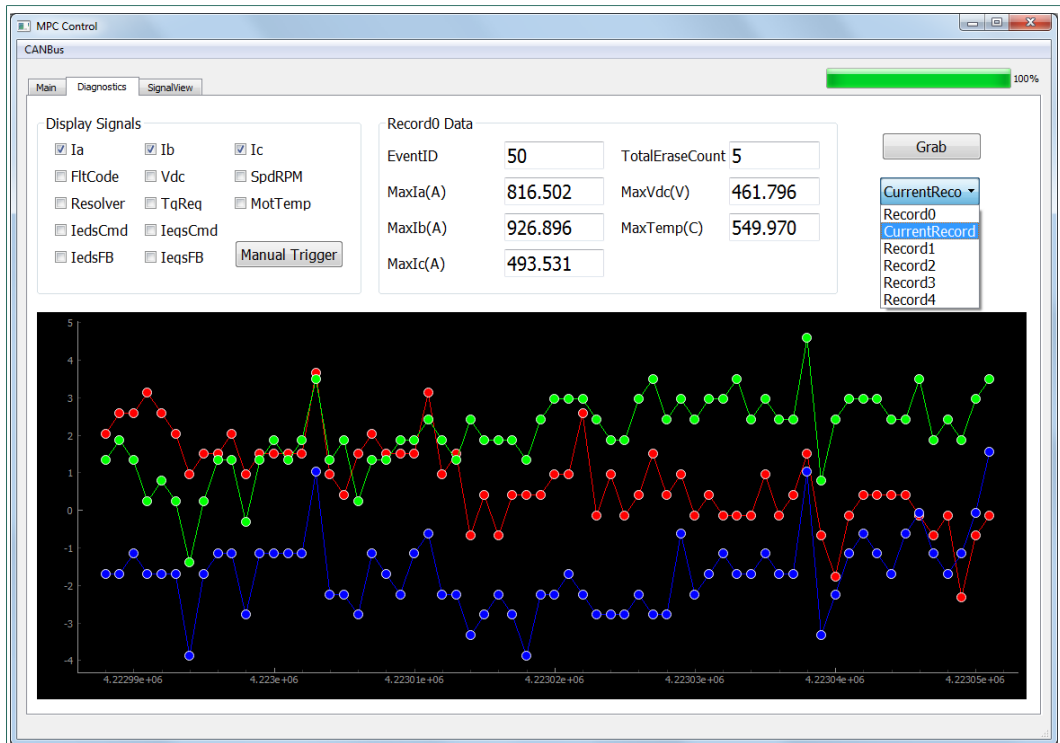

Figure 12. Motor phase current data

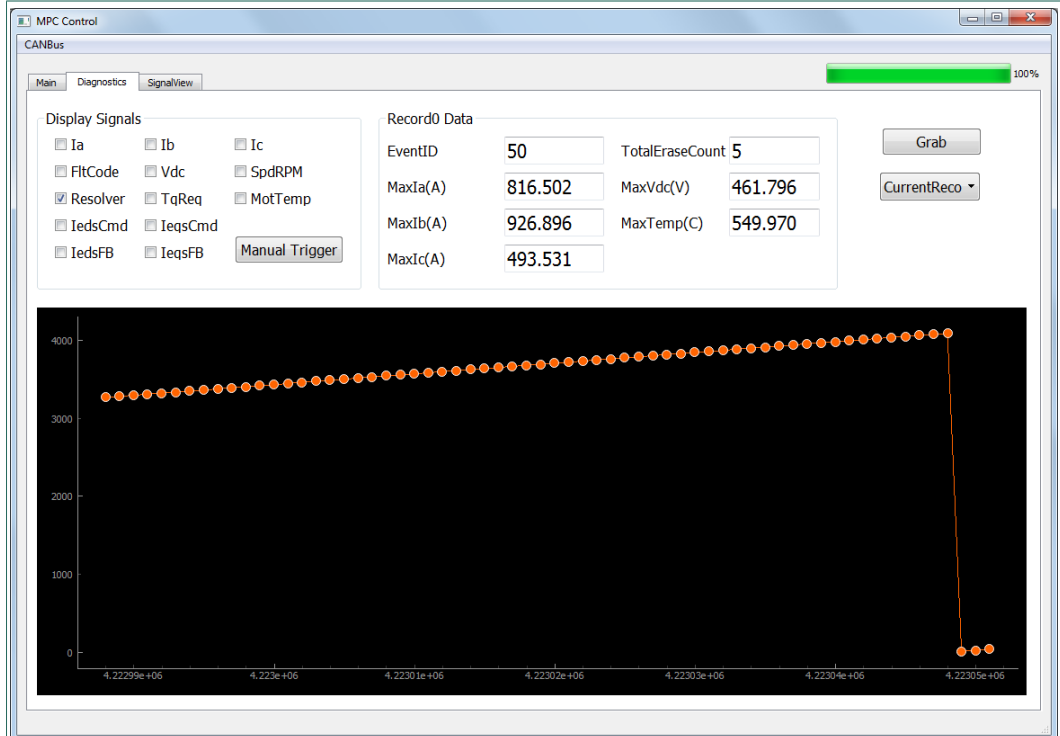

Figure 13. Resolver position data

The software provides the graphical view of arbitrary signal when requested. It records 2048 data at T0 rate. To retrieve a desired signal, first lookup the map file. For example, the output duty of the C phase pwm is shown in



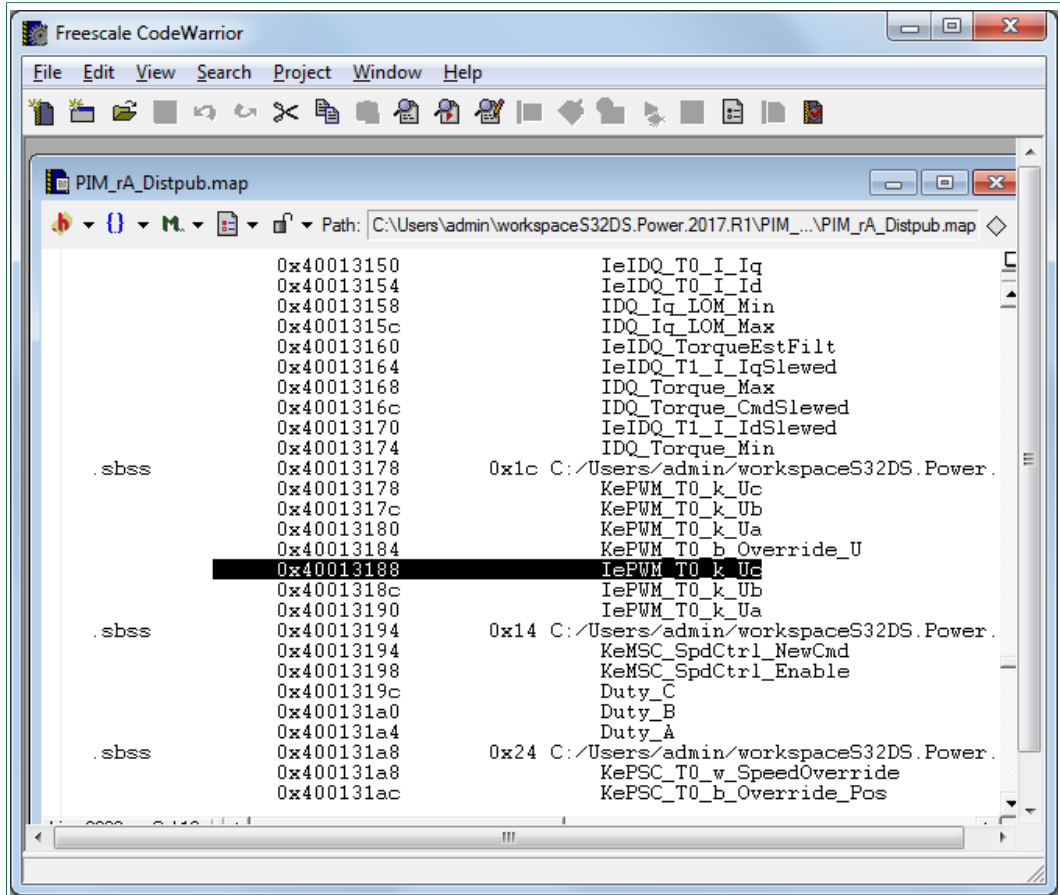

Figure 14. Variable address in map file

Fill the Addr(hex) fields according to the map address, then choose the right format of the variable before click the **Dump** button.

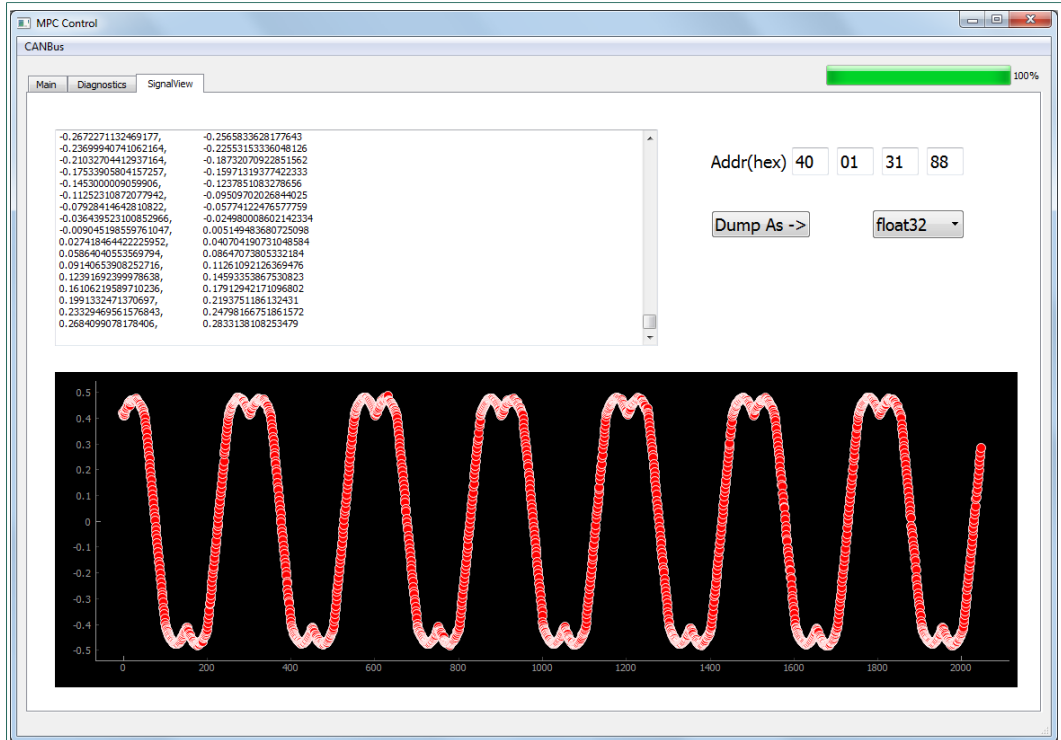

Figure 15. Output variable graph

Too zoom in and out the graph, use the right mouse button. To reset, click the **A** button at lower left corner of the display area.

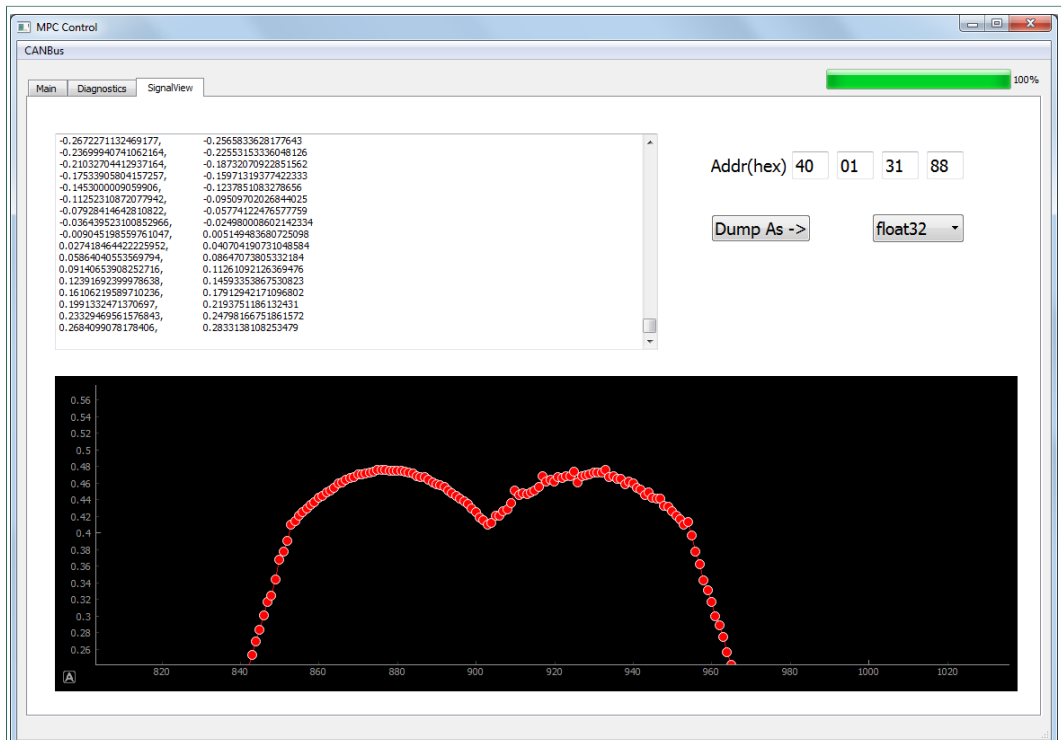

Figure 16. Graph zoomed in

## 7 Software development tools

NXP has software development tools available for use with the NXP MPC5777C development board (DEVB). The development board is intended to provide a platform for easy customer evaluation of the MPC5777C microcontroller and to facilitate hardware and software development. The development board can be used for powertrain/inverters/Battery Management Systems (BMS)/automotive Ethernet, etc. The latest product information is available at [www.nxp.com/MPC5777C](http://www.nxp.com/MPC5777C).

Development software, available at <http://www.nxp.com>:

- **S32S Design Studio IDE for power architecture:**  
The S32S design studio for power architecture IDE installed on a Windows PC workstation enables editing, compiling and debugging of source code designs. SDK supports several devices including MPC5777C.
- **Automotive Math and Motor Control Library (AMMCL):**  
The AMMCL is a precompiled software library containing the building blocks for a wide range of motor control and general mathematical applications.
- **FreeMaster 2.0 runtime debugging tool:**  
FreeMASTER runtime debugging tool is a separate download and can also be used in conjunction with the MCU code developed with S32DS as a user-friendly realtime debug monitor, graphical control panel, and data visualization tool for application development and information management.
- **Motor Control Application Tuning (MCAT):**  
The MCAT is a FreeMASTER plug-in tool intended for the development of PMSM FOC and BLDC motor control applications.
- **Example code, GD3100 Device Driver notes and GD3100 Device Driver Reference notes:**  
GD3100 Device Driver example code REV1.1, or later, provides a basis to get started and begin software development for the desired motor control.

## 8 Schematics, board layout and bill of materials

The board schematics, board layout and bill of materials are available at <http://www.nxp.com/HV-INVERTER>.

## 9 References

- [1] Tool summary page for HV-INVERTER — <http://www.nxp.com/HV-INVERTER>
- [2] Product summary page for GD3100 — <http://www.nxp.com/GD3100>
- [3] Product summary page for MC5775E — <http://www.nxp.com/MC5775E>
- [4] Product summary page for FS6523 — <http://www.nxp.com/FS6523>
- [5] Product summary page for TJA1042 — <http://www.nxp.com/TJA1042>
- [6] Product summary page for Fuji M653 — [http://www.nxp.com/Fuji\\_M653](http://www.nxp.com/Fuji_M653)
- [7] Vepco Technologies — <http://www.vepcotech.com/>

## 10 Revision history

### Revision history

Rev	Date	Description
1	20191004	<ul style="list-style-type: none"><li>Initial version</li></ul>

## 11 Legal information

### 11.1 Definitions

**Draft** — The document is a draft version only. The content is still under internal review and subject to formal approval, which may result in modifications or additions. NXP Semiconductors does not give any representations or warranties as to the accuracy or completeness of information included herein and shall have no liability for the consequences of use of such information.

### 11.2 Disclaimers

**Limited warranty and liability** — Information in this document is believed to be accurate and reliable. However, NXP Semiconductors does not give any representations or warranties, expressed or implied, as to the accuracy or completeness of such information and shall have no liability for the consequences of use of such information. NXP Semiconductors takes no responsibility for the content in this document if provided by an information source outside of NXP Semiconductors. In no event shall NXP Semiconductors be liable for any indirect, incidental, punitive, special or consequential damages (including - without limitation - lost profits, lost savings, business interruption, costs related to the removal or replacement of any products or rework charges) whether or not such damages are based on tort (including negligence), warranty, breach of contract or any other legal theory. Notwithstanding any damages that customer might incur for any reason whatsoever, NXP Semiconductors' aggregate and cumulative liability towards customer for the products described herein shall be limited in accordance with the Terms and conditions of commercial sale of NXP Semiconductors.

**Right to make changes** — NXP Semiconductors reserves the right to make changes to information published in this document, including without limitation specifications and product descriptions, at any time and without notice. This document supersedes and replaces all information supplied prior to the publication hereof.

**Suitability for use** — NXP Semiconductors products are not designed, authorized or warranted to be suitable for use in life support, life-critical or safety-critical systems or equipment, nor in applications where failure or malfunction of an NXP Semiconductors product can reasonably be expected to result in personal injury, death or severe property or environmental damage. NXP Semiconductors and its suppliers accept no liability for inclusion and/or use of NXP Semiconductors products in such equipment or applications and therefore such inclusion and/or use is at the customer's own risk.

**Applications** — Applications that are described herein for any of these products are for illustrative purposes only. NXP Semiconductors makes no representation or warranty that such applications will be suitable for the specified use without further testing or modification. Customers are responsible for the design and operation of their applications and products using NXP Semiconductors products, and NXP Semiconductors accepts no liability for any assistance with applications or customer product design. It is customer's sole responsibility to determine whether the NXP Semiconductors product is suitable and fit for the customer's applications and products planned, as well as for the planned application and use of customer's third party customer(s). Customers should provide appropriate design and operating safeguards to minimize the risks associated with their applications and products. NXP Semiconductors does not accept any liability related to any default, damage, costs or problem which is based on any weakness or default in the customer's applications or products, or the application or use by customer's third party customer(s). Customer is responsible for doing all necessary testing for the customer's applications and products using NXP Semiconductors products in order to avoid a

default of the applications and the products or of the application or use by customer's third party customer(s). NXP does not accept any liability in this respect.

**Suitability for use in automotive applications** — This NXP Semiconductors product has been qualified for use in automotive applications. Unless otherwise agreed in writing, the product is not designed, authorized or warranted to be suitable for use in life support, life-critical or safety-critical systems or equipment, nor in applications where failure or malfunction of an NXP Semiconductors product can reasonably be expected to result in personal injury, death or severe property or environmental damage. NXP Semiconductors and its suppliers accept no liability for inclusion and/or use of NXP Semiconductors products in such equipment or applications and therefore such inclusion and/or use is at the customer's own risk.

**Export control** — This document as well as the item(s) described herein may be subject to export control regulations. Export might require a prior authorization from competent authorities.

**Evaluation products** — This product is provided on an "as is" and "with all faults" basis for evaluation purposes only. NXP Semiconductors, its affiliates and their suppliers expressly disclaim all warranties, whether express, implied or statutory, including but not limited to the implied warranties of non-infringement, merchantability and fitness for a particular purpose. The entire risk as to the quality, or arising out of the use or performance, of this product remains with customer. In no event shall NXP Semiconductors, its affiliates or their suppliers be liable to customer for any special, indirect, consequential, punitive or incidental damages (including without limitation damages for loss of business, business interruption, loss of use, loss of data or information, and the like) arising out of the use of or inability to use the product, whether or not based on tort (including negligence), strict liability, breach of contract, breach of warranty or any other theory, even if advised of the possibility of such damages. Notwithstanding any damages that customer might incur for any reason whatsoever (including without limitation, all damages referenced above and all direct or general damages), the entire liability of NXP Semiconductors, its affiliates and their suppliers and customer's exclusive remedy for all of the foregoing shall be limited to actual damages incurred by customer based on reasonable reliance up to the greater of the amount actually paid by customer for the product or five dollars (US\$5.00). The foregoing limitations, exclusions and disclaimers shall apply to the maximum extent permitted by applicable law, even if any remedy fails of its essential purpose.

**Translations** — A non-English (translated) version of a document is for reference only. The English version shall prevail in case of any discrepancy between the translated and English versions.

**Security** — While NXP Semiconductors has implemented advanced security features, all products may be subject to unidentified vulnerabilities. Customers are responsible for the design and operation of their applications and products to reduce the effect of these vulnerabilities on customer's applications and products, and NXP Semiconductors accepts no liability for any vulnerability that is discovered. Customers should implement appropriate design and operating safeguards to minimize the risks associated with their applications and products.

### 11.3 Trademarks

Notice: All referenced brands, product names, service names and trademarks are the property of their respective owners.

**NXP** — is a trademark of NXP B.V.

**SafeAssure** — is a trademark of NXP B.V.

## Tables

Tab. 1.	Vehicle interface 30-pin connector definitions .....	6	Tab. 7.	Phase currents 10-pin connector definitions ....	12
Tab. 2.	Driver signals 40-pin connector definitions .....	7	Tab. 8.	EV-INTERFACEVB 30-pin connector definitions .....	12
Tab. 3.	Phase currents 10-pin connector definitions .....	8	Tab. 9.	EV-INTERFACEVB connections .....	17
Tab. 4.	Phase extra debug GPIOs 14-pin connector definitions .....	8	Tab. 10.	Optional connections .....	17
Tab. 5.	Phase extra debug GPIOs 14-pin connector definitions .....	9	Tab. 11.	Software descriptions .....	18
Tab. 6.	Driver signals 40-pin connector definitions .....	10	Tab. 12.	Inverter control states .....	26
			Tab. 13.	Fault codes .....	27

## Figures

Fig. 1.	Enablement kit block diagram .....	5	Fig. 9.	EV-INTERFACEVB connections .....	16
Fig. 2.	EV-CONTROLEVM connectors .....	5	Fig. 10.	EV-INTERFACEVB connections .....	16
Fig. 3.	JTAG connector schematic .....	9	Fig. 11.	Connecting the USB-CAN interface adapter to a USB port on the computer. ....	22
Fig. 4.	EV-SENSOREVB connector .....	10	Fig. 12.	Motor phase current data .....	28
Fig. 5.	EV-SENSOREVB connector .....	11	Fig. 13.	Resolver position data .....	28
Fig. 6.	EV-SENSOREVB connector .....	12	Fig. 14.	Variable address in map file .....	29
Fig. 7.	Veeco Technologies EV inverter platform used as an illustration of a completed inverter .....	14	Fig. 15.	Output variable graph .....	30
Fig. 8.	Board configuration with cables .....	15	Fig. 16.	Graph zoomed in .....	30

## Contents

<b>1</b>	<b>Finding kit resources and information on the NXP web site</b>	<b>2</b>
1.1	Collaborate in the NXP Community	2
<b>2</b>	<b>Getting started</b>	<b>2</b>
2.1	Kit contents	2
2.2	Additional hardware	2
2.3	Interface connections	3
2.4	Windows PC workstation	3
2.5	Software	3
<b>3</b>	<b>Getting to know the hardware</b>	<b>4</b>
3.1	Enablement kit overview	4
3.2	EV-INVERTER enablement kit features	4
3.3	EV-INVERTER Enablement kit block diagram	5
3.4	Board descriptions	5
3.4.1	EV-CONTROLEVM board connectors	5
3.4.1.1	Vehicle Interface connector pinout	6
3.4.1.2	Driver signals connector pinout	7
3.4.1.3	Phase currents connector pinout	8
3.4.1.4	Phase extra debug GPIOs connector pinout	8
3.4.1.5	JTAG connector pinout	8
3.4.2	EV-POWERVEB board connector	10
3.4.2.1	Driver signals connector pinout	10
3.4.3	EV-SENSOREVB board connectors	11
3.4.3.1	EV-SENSOREVB connector pinout	12
3.4.4	EV-INTERFACEVB board connectors	12
3.4.4.1	EV-INTERFACEVB connector pinout	12
<b>4</b>	<b>Assembling the hardware</b>	<b>13</b>
4.1	Using a motor not from Vepco Tehnologies	15
<b>5</b>	<b>Software requirements and installation</b>	<b>18</b>
5.1	S32 Design Studio for Power Architecture 2017.R1	18
5.2	Installing the USB – CAN interface adapter	21
5.2.1	Steps to disable the driver signature enforcement in Windows 10	22
5.3	Python setup	23
5.4	Running the PIM GUI	24
<b>6</b>	<b>Operation of the Power Inverter Module (PIM)</b>	<b>25</b>
6.1	Demo software	25
6.2	BSW software	25
6.3	Diagnostics	27
<b>7</b>	<b>Software development tools</b>	<b>31</b>
<b>8</b>	<b>Schematics, board layout and bill of materials</b>	<b>31</b>
<b>9</b>	<b>References</b>	<b>31</b>
<b>10</b>	<b>Revision history</b>	<b>32</b>
<b>11</b>	<b>Legal information</b>	<b>33</b>

Please be aware that important notices concerning this document and the product(s) described herein, have been included in section 'Legal information'.

© NXP B.V. 2019.

All rights reserved.

For more information, please visit: <http://www.nxp.com>

For sales office addresses, please send an email to: [salesaddresses@nxp.com](mailto:salesaddresses@nxp.com)

Date of release: 4 October 2019  
Document identifier: UM11298