

GENERAL DESCRIPTION

The SGM448 can detect the temperature from -55°C to $+150^{\circ}\text{C}$ and its operation voltage level is from 2.7V to 10V. For the output voltage stage, the DC offset voltage is equal to 424mV at 0°C and it changes linearly with $6.25\text{mV}/^{\circ}\text{C}$. The beneficial of the positive offset voltage is that it can allow the SGM448 to read negative temperature accurately. For measuring the temperature range from -55°C to $+150^{\circ}\text{C}$, the corresponding nominal output voltage range is from 80.25mV to 1361.5mV. The SGM448 is calibrated to achieve the accuracy of $\pm 1^{\circ}\text{C}$ (MAX) at $+25^{\circ}\text{C}$ and $\pm 2.5^{\circ}\text{C}$ (MAX) at full measurable range of temperature.

The SGM448 can simplify the required external circuit for the measurement of negative temperature through its excellent linearity, positive offset voltage and calibration of factory. A class-AB output driver provides a strong $500\mu\text{A}$ maximum output to drive capacitive loads up to 2000pF and is designed to directly interface to analog-to-digital converter sample and hold inputs. The quiescent current of the device is $26\mu\text{A}$ (TYP), which means that its temperature caused by the $26\mu\text{A}$ quiescent current is within 0.1°C in still air. The shutdown capability which is inside the SGM448 allows it to be powered by MCU directly as its low consumption of power.

The SGM448 is available in a Green SOT-23 package and specified over the extended -55°C to $+150^{\circ}\text{C}$ temperature range.

FEATURES

- **2.7V to 10V Supply Voltage Range**
- **Temperature Accuracy:**
 - ◆ **$+25^{\circ}\text{C}$: $\pm 1^{\circ}\text{C}$ (MAX)**
 - ◆ **-55°C to $+150^{\circ}\text{C}$: $\pm 2.5^{\circ}\text{C}$ (MAX)**
- **Offset Output Voltage: 424mV at 0°C (TYP)**
- **Calibrated Linear Scale Factor: $6.25\text{mV}/^{\circ}\text{C}$**
- **Current Drain at $+25^{\circ}\text{C}$: $26\mu\text{A}$ (TYP)**
- **Nonlinearity: $\pm 0.5^{\circ}\text{C}$ (TYP)**
- **Strong Output for Driving Loads up to 2000pF**
- **Short-Circuit Protection Output**
- **Suitable for Remote Applications**
- **Available in a Green SOT-23 Package**

APPLICATIONS

Cell Phones and Computers
 Power Supply Modules
 Battery Management
 Fax Machines and Printers
 HVAC and Disk Drives

SIMPLIFIED SCHEMATIC

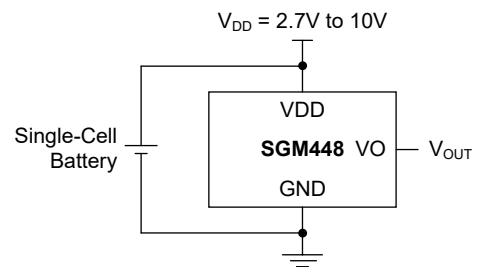

Figure 1. Simplified Schematic

PACKAGE/ORDERING INFORMATION

MODEL	PACKAGE DESCRIPTION	SPECIFIED TEMPERATURE RANGE	ORDERING NUMBER	PACKAGE MARKING	PACKING OPTION
SGM448	SOT-23	-55°C to +150°C	SGM448TN3LG/TR	ME7XX	Tape and Reel, 3000

Green (RoHS & HSF): SG Micro Corp defines "Green" to mean Pb-Free (RoHS compatible) and free of halogen substances. If you have additional comments or questions, please contact your SGMICRO representative directly.

MARKING INFORMATION

NOTE: XX = Date Code.

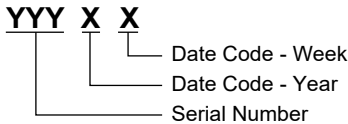

ABSOLUTE MAXIMUM RATINGS

- Supply Voltage Range -0.2V to 12V
- Output Voltage Range -0.3V to 6V
- Output Current Range -2mA to 2mA
- Latch-up Current Range, Each Pin -150mA to 150mA
- Package Thermal Resistance
- SOT-23, θ_{JA} 290°C/W
- Junction Temperature +150°C
- Storage Temperature Range -65°C to +150°C
- Lead Temperature (Soldering, 10s) +260°C
- ESD Susceptibility
- HBM 4000V
- CDM 1000V

RECOMMENDED OPERATING CONDITIONS

- Supply Voltage Range, V_{DD} 2.7V to 10V
- Operating Ambient Temperature -55°C to +150°C

OVERSTRESS CAUTION

Stresses beyond those listed in Absolute Maximum Ratings may cause permanent damage to the device. Exposure to absolute maximum rating conditions for extended periods may affect reliability. Functional operation of the device at any conditions beyond those indicated in the Recommended Operating Conditions section is not implied.

ESD SENSITIVITY CAUTION

This integrated circuit can be damaged if ESD protections are not considered carefully. SGMICRO recommends that all integrated circuits be handled with appropriate precautions. Failure to observe proper handling and installation procedures can cause damage. ESD damage can range from subtle performance degradation to complete device failure. Precision integrated circuits may be more susceptible to damage because even small parametric changes could cause the device not to meet the published specifications.

DISCLAIMER

SG Micro Corp reserves the right to make any change in circuit design, or specifications without prior notice.

PIN CONFIGURATION

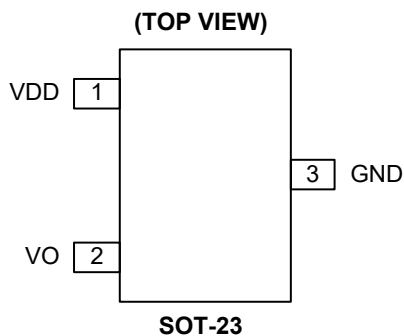

PIN DESCRIPTION

PIN	NAME	FUNCTION
1	VDD	Positive Power Supply Pin.
2	VO	Output Voltage Pin. The output voltage is proportional to measured temperature.
3	GND	Ground.

ELECTRICAL CHARACTERISTICS(V_{DD} = 2.7V to 10V, T_A = -55°C to +150°C, GND = Ground and no load, unless otherwise noted.)

PARAMETER	SYMBOL	CONDITIONS	MIN	TYP	MAX	UNITS
Power Supply						
Operating Current	I _{DD}	T _A = +25°C, V _{DD} = 3V		26	39	μA
		T _A = +150°C		36	49	
Line Regulation	Δ°C/ΔV _{DD}		-0.08	±0.02	0.08	°C/V
Sensor Accuracy						
Temperature Accuracy ⁽¹⁾	T _{ACC}	T _A = +25°C	-1	±0.5	1	°C
		T _A = -55°C to +150°C	-2.5	±1	2.5	
Sensor Output						
Offset Output Voltage	V _{OFFS}	T _A = 0°C		424		mV
Temperature Coefficient (Sensor Gain)	T _C			6.25		mV/°C
Output Nonlinearity ⁽¹⁾	V _{ONL}	T _A = -55°C to +150°C, no load		±0.5		°C
Output Current	I _{OUT}				500	μA
Output Impedance	Z _{OUT}	I _{OUT} = 100μA, f = 100Hz		4		Ω
		I _{OUT} = 100μA, f = 500Hz		9		
Output Load Regulation		T _A = -55°C to +150°C, I _{OUT} = 100μA, ΔV _{OUT} /ΔI _{OUT}		0.5		Ω
Power-On Time	t _{ON}	Time to reach accuracy within ±0.5°C		340	620	μs
Typical Load Capacitance	C _{LOAD}				2000	pF

NOTE:

1. The accuracy of the temperature is essential and it is the voltage difference between the measured and the output voltage. The line regulation also should be taken into consideration as the accuracy limits. However, the effect of DC load (load regulation) is not considered since the accuracy limit is for no load case.

TYPICAL PERFORMANCE CHARACTERISTICS

T_A = +25°C, unless otherwise noted.

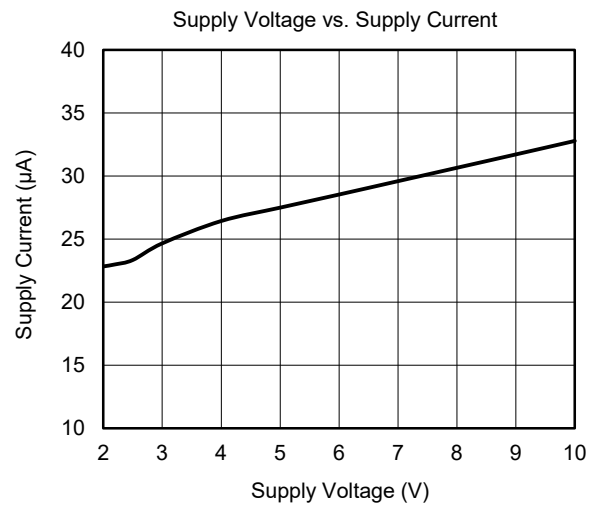
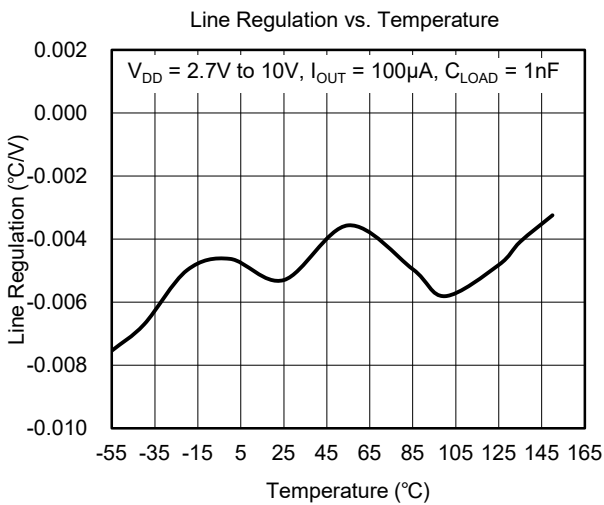
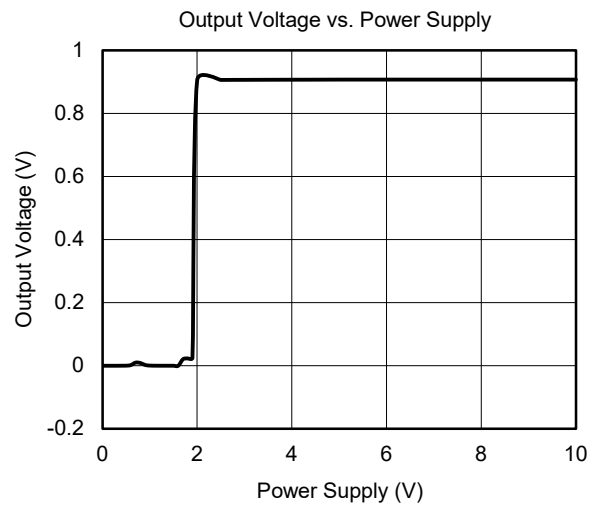
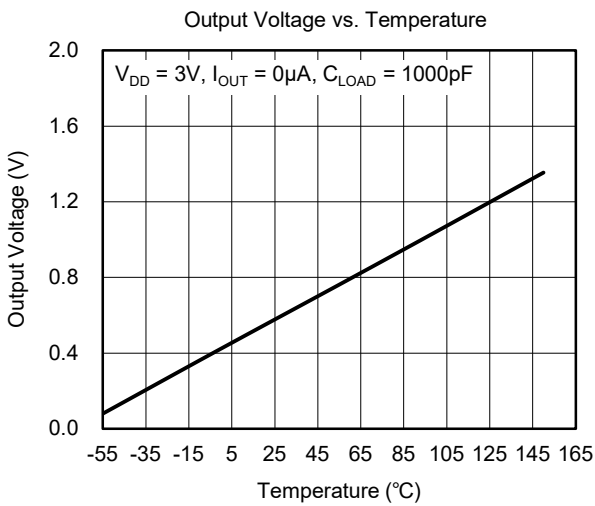
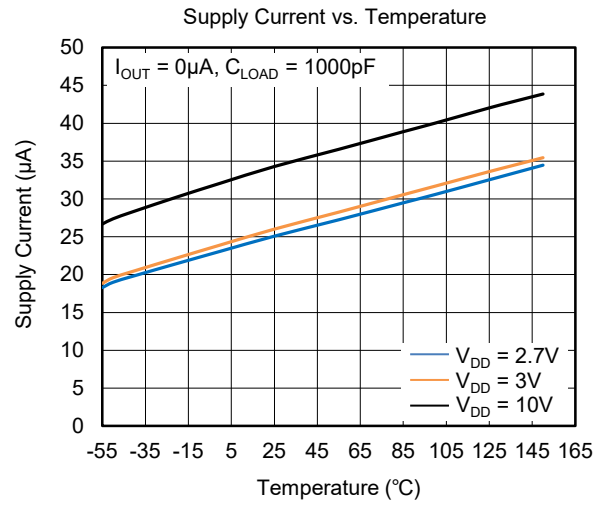
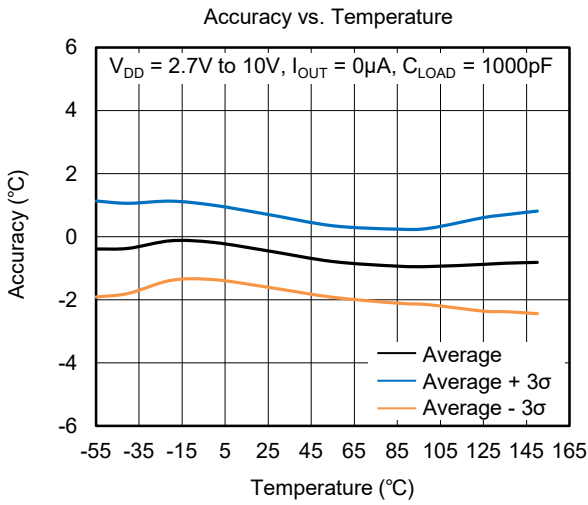

TYPICAL PERFORMANCE CHARACTERISTICS (continued)

T_A = +25°C, unless otherwise noted.

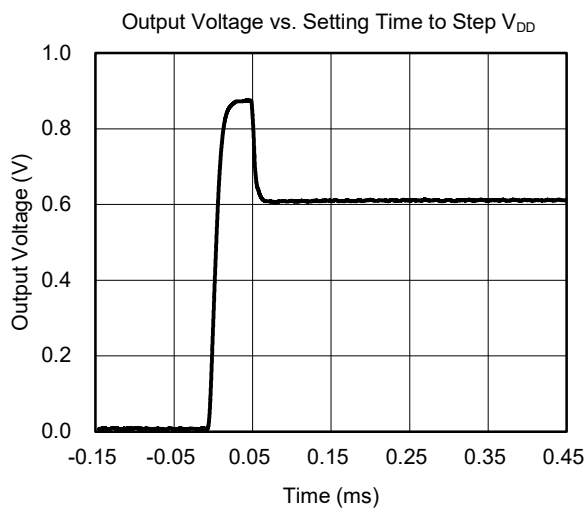
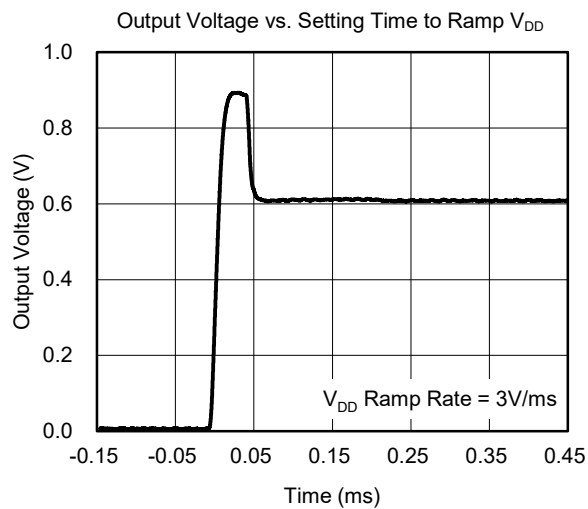
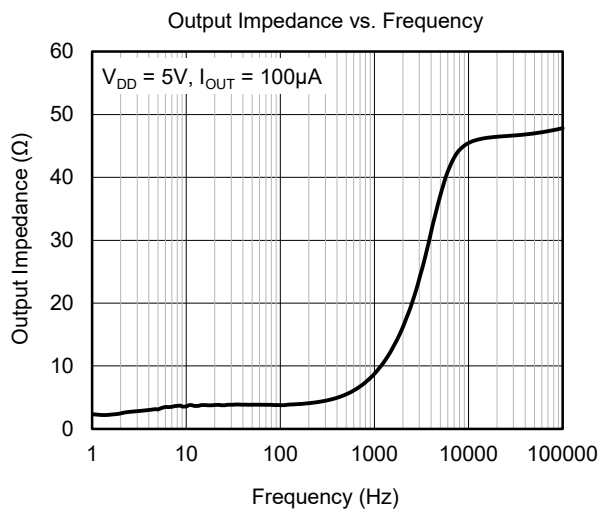

FUNCTIONAL BLOCK DIAGRAM

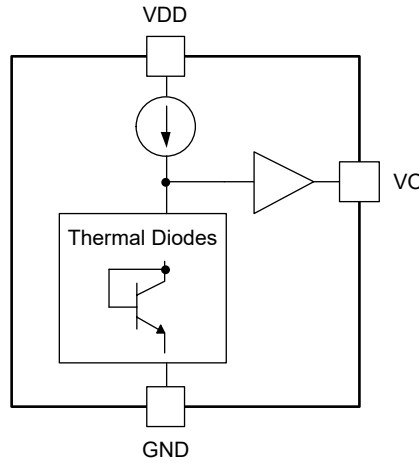

Figure 2. Block Diagram

DETAILED DESCRIPTION

Overview

The SGM448 can detect the temperature from -55°C to +150°C and its operation voltage level is from 2.7V to 10V. For the output voltage stage, the DC offset voltage is equal to 424mV at 0°C and it changes linearly with 6.25mV/°C. The beneficial of the positive offset voltage is that it can allow the SGM448 to read negative temperature accurately. For measuring the temperature range from -55 °C to +150 °C, the corresponding nominal output voltage range is from 80.25mV to 1361.5mV. The SGM448 is calibrated to achieve the accuracy of ±1°C (MAX) at +25°C and ±2.5°C (MAX) at full measurable range of temperature. The delta-VBE architecture is comprised inside the device. And there is a buffer between the output stage and the temperature sensing parts.

Feature Description

SGM448 Transfer Function

The following equation is a linear transfer function that is used for calculating the V_{OUT} of SGM448, the output voltage is proportional to the measured temperature.

$$V_{OUT} = 6.25(mV/°C) \times T(°C) + 424(mV) \quad (1)$$

Where T is the temperature in °C and V_{OUT} is the output voltage of VO pin.

Table 1. Temperature and Typical V_{OUT} Values

Temperature	V_{OUT} (TYP)
+150°C	1361.5mV
+125°C	1205.25mV
+100°C	1049mV
+85°C	955.25mV
+25°C	580.25mV
0°C	424mV
-25°C	267.75mV
-30°C	236.5mV
-50°C	111.5mV
-55°C	80.25mV

Device Functional Mode

Analog output proportional to temperature is the only functional mode of the SGM448.

APPLICATION INFORMATION

Because of the advantages of low power consumption and high supply voltage range, the SGM448 can be used in applications that measure extreme positive and negative temperatures with a single power supply.

Typical Temperature Sensing Circuit

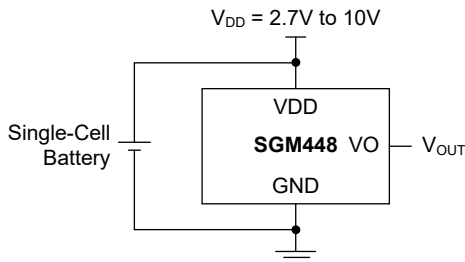

Figure 3. Typical Temperature Sensing Circuit

Design Requirements

Table 2 lists the recommended input parameters of Figure 3.

Table 2. Design Parameters

Parameter	Value
Power Supply Voltage	2.7V to 10V
Accuracy at +25°C	±1°C (MAX)
Accuracy over -55°C to +150°C	±2.5°C (MAX)
Temperature Slope	6.25mV/°C

Capacitive Loads

For noisy conditions, such as driving a SAR ADC, an output capacitor is necessary to filter out output noise due to the switching input of the load. The SGM448 has outstanding capacitive loading capability. In Figure 4, the SGM448 can handle a 2000pF capacitive load. However, if the load capacitance is larger than 2000pF, a series resistor should be used to compensate for the

SGM448 in Figure 5. If the C_L value is 2nF to 1µF, the minimum value of R_S should be 800Ω.

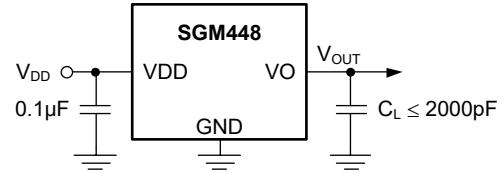

Figure 4. Application Circuit for Capacitive Loading Less than 2000pF

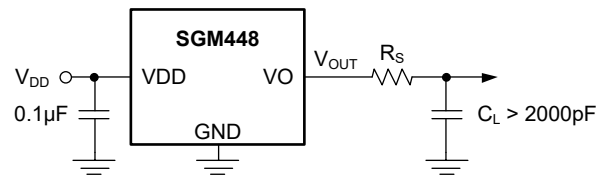

Figure 5. SGM448 with Series Resistor for Capacitive Loading Greater than 2000pF

Power Supply Recommendations

To reduce the effect of a noisy power supply, an RC filter can be used to decrease the noise pick-up. And a 0.1µF capacitor should be taken into account.

Other Application Circuits

Centigrade Thermostat Application

The hysteresis comparator can be used to indicate high or low state for different temperatures. Before designing the example of Figure 6 in this section, it is recommended that the customers test and validate the circuit. The parameters in the section of Typical Temperature Sensing Circuit can be taken into account unless there are any noted specifications.

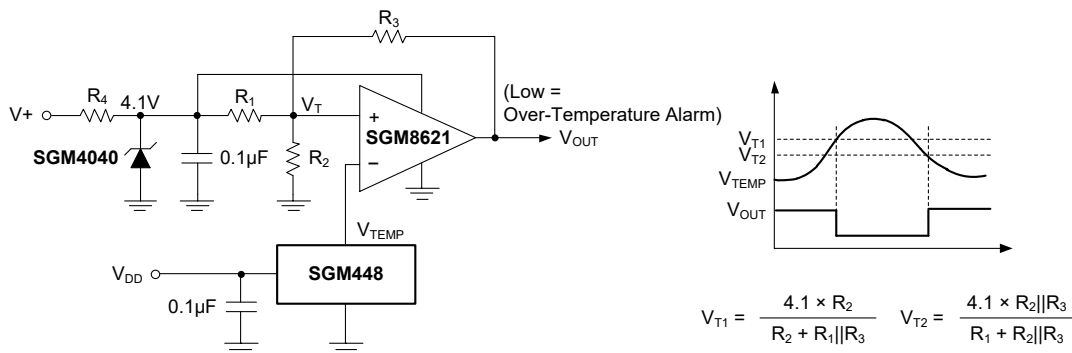

Figure 6. Celsius Thermostat

$$V_{T1} = \frac{4.1 \times R_2}{R_2 + R_1 || R_3} \quad V_{T2} = \frac{4.1 \times R_2 || R_3}{R_1 + R_2 || R_3}$$

APPLICATION INFORMATION (continued)

Conserving Power Dissipation with Shutdown

The SGM448 can be shutdown with an output of a logic gate because of its ultra-low power dissipation, as shown in Figure 7.

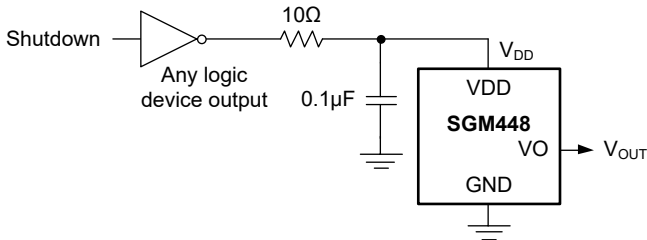

Figure 7. Conserving Power Dissipation with Shutdown

Connection for the Input Stage of SAR ADC

Most of the CMOS-based ADCs are integrated in microcontroller and have a sampling capacitor input structure. In addition, for charging the sampling capacitor of ADC, it needs the instantaneous charge from the output of the source. Adding an output capacitor (C_{FILT}) can satisfy this requirement. For the size of C_{FILT} , it depends on the sampling frequency and the size of sampling capacitor. However, the input stages of the ADCs are not exactly the same, and thus the conditions of charge are also different. Figure 8 is just one example to show what the input stage of SAR ADC looks like.

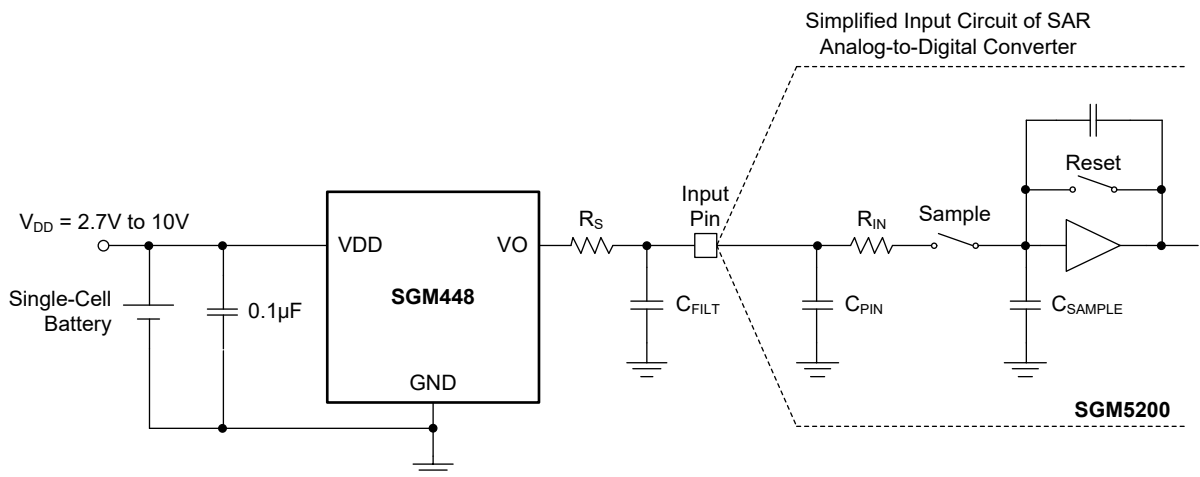

Figure 8. Suitable Connection for the Input Stage of SAR ADC

LAYOUT

Layout Guidelines

The SGM448 can be applied as easily as other temperature sensors, and can be glued or cemented on the surface. The difference between the sensing temperature and the actual temperature of the surface that the SGM448 is tied to is within 0.2°C.

However, the above presume is under the condition where the temperature of the air and the surface are equal. If the air temperature is variable and its temperature is lower or higher than the surface temperature which is closed to the SGM448, the calculated temperature is the average of both air temperature and surface temperature.

For enhancing the conductivity of the thermal, the backside of the die is connected to GND. The lands and traces are the parts of the PCB layout and also the temperature object of the SGM448.

Besides, the SGM448 can be installed inside a metal tube, or be screwed into a threaded hole. In addition, the customer needs to be aware that the circuit and the external traces which are connected to the PCB board need to be kept dry enough and isolated, which can prevent the device from leakage and corrosion, especially for the condensate conditions. The conformal coating and epoxy paints should be taken into account in order to avoid the connections in the PCB board from moisture.

REVISION HISTORY

NOTE: Page numbers for previous revisions may differ from page numbers in the current version.

AUGUST 2022 – REV.A to REV.A.1	Page
Updated Electrical Characteristics section	4
Changes from Original (AUGUST 2022) to REV.A	Page
Changed from product preview to production data	All

PACKAGE OUTLINE DIMENSIONS

SOT-23

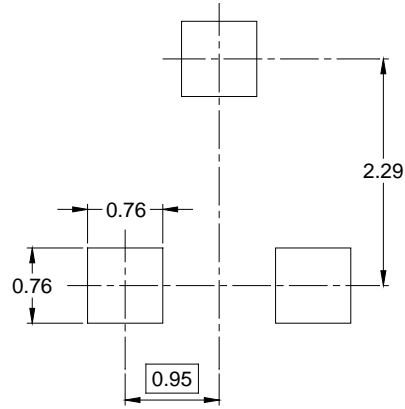
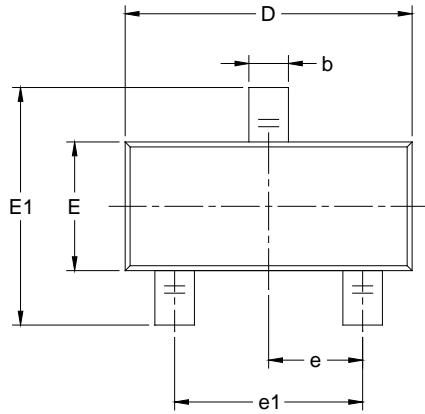

RECOMMENDED LAND PATTERN (Unit: mm)

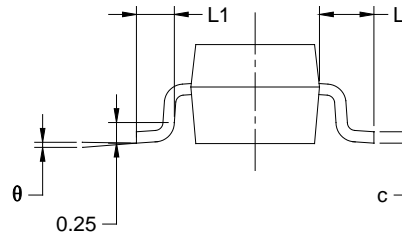
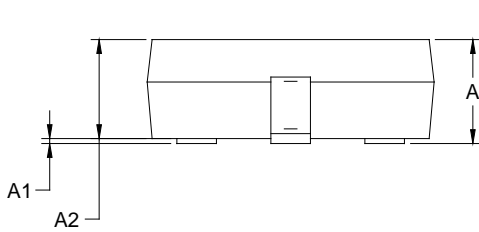

Symbol	Dimensions In Millimeters		Dimensions In Inches	
	MIN	MAX	MIN	MAX
A	0.89	1.12	0.035	0.044
A1	0.01	0.10	0.000	0.004
A2	0.88	1.02	0.035	0.040
b	0.30	0.50	0.012	0.020
c	0.08	0.20	0.003	0.008
D	2.80	3.04	0.110	0.120
E	1.20	1.40	0.047	0.055
E1	2.10	2.64	0.083	0.104
e	0.95 BSC		0.037 BSC	
e1	1.90 BSC		0.075 BSC	
L	0.54 REF		0.021 REF	
L1	0.40	0.60	0.016	0.024
θ	0°	8°	0°	8°

NOTES:

1. Body dimensions do not include mode flash or protrusion.
2. This drawing is subject to change without notice.

PACKAGE INFORMATION

TAPE AND REEL INFORMATION

REEL DIMENSIONS



TAPE DIMENSIONS



NOTE: The picture is only for reference. Please make the object as the standard.

KEY PARAMETER LIST OF TAPE AND REEL

Package Type	Reel Diameter	Reel Width W1 (mm)	A0 (mm)	B0 (mm)	K0 (mm)	P0 (mm)	P1 (mm)	P2 (mm)	W (mm)	Pin1 Quadrant
SOT-23	7"	9.5	3.15	2.77	1.22	4.0	4.0	2.0	8.0	Q3

000001

PACKAGE INFORMATION

CARTON BOX DIMENSIONS



NOTE: The picture is only for reference. Please make the object as the standard.

KEY PARAMETER LIST OF CARTON BOX

Reel Type	Length (mm)	Width (mm)	Height (mm)	Pizza/Carton
7" (Option)	368	227	224	8
7"	442	410	224	18

DD0002