

MAIN CHARACTERISTICS

I_D	4A
V_{DSS}	650V
$R_{DS(ON)-typ}$ (@ $V_{GS}=10V$)	2.2 Ω

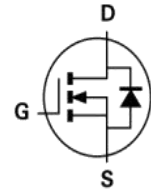

FEATURES

- Fast Switching
- Low ON Resistance
- Low Gate Charge
- 100% Single Pulse avalanche energy Test

APPLICATIONS

- Power switch circuit of adaptor and charger.

MECHANICAL DATA

- Case: Molded plastic
- Mounting Position: Any
- Molded Plastic: UL Flammability Classification Rating 94V-0
- Lead free in compliance with EU RoHS 2011/65/EU directive
- Solder bath temperature 275°C maximum, 10s per JESD 22-B106

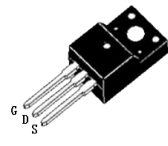

TO-220F

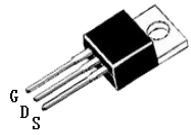

TO-220AB

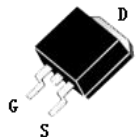

TO-263

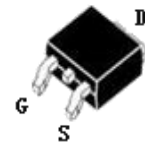

TO-252

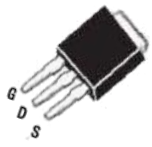

TO-251

Product specification classification

Part Number	Package	Mode Name	Pack
CS4N65A2	TO-220F (0.5mm)	CS4N65A	Tube
CS4N65A1	TO-220AB	CS4N65A	Tube
CS4N65A3	TO-263	CS4N65A	Tube
CS4N65A3-R	TO-263	CS4N65A	Tape
CS4N65A4	TO-251	CS4N65A	Tube
CS4N65A5-R	TO-252	CS4N65A	Tape

Maximum Ratings at Tc=25°C unless otherwise specified

Characteristics	Symbol	Value			Unit
		220AB/263	220F	251/252	
Drain-Source Voltage	V_{DS}	650			V
Gate-Source Voltage	V_{GS}	±30			V
Continue Drain Current	I_D	4			A
Pulsed Drain Current (Note1)	I_{DM}	20			A
Power Dissipation	P_D	85	30	85	W
Single Pulse Avalanche Energy (Note1)	E_{AS}	150			mJ
Operating Temperature Range	T_J	150			°C
Storage Temperature Range	T_{STG}	-55 to +150			°C
Thermal Resistance, Junction to Case	$R_{\theta JC}$	1.67	4.17	1.67	°C/W
Thermal Resistance, Junction to Ambient	$R_{\theta JA}$	62.5	100	62.5	°C/W

Note1:Pulse test: 300 μs pulse width, 2 % duty cycle

Electrical Characteristics at Tc=25°C unless otherwise specified

Characteristics	Test Condition	Symbol	Min	Typ	Max	Unit
Drain-Source Breakdown Voltage	$V_{GS} = 0 V, I_D = 250 \mu A$	BV_{DSS}	650	680	-	V
Drain-Source Leakage Current	$V_{DS} = 650 V, V_{GS} = 0 V$	I_{DSS}	-	-	1	μA
Gate Leakage Current	$V_{GS} = \pm 32 V, V_{DS} = 0 V$	I_{GSS}	-	-	±100	nA
Gate-Source Threshold Voltage	$V_{DS} = V_{GS}, I_D = 250 \mu A$	$V_{GS(th)}$	2	-	4	V
Drain-Source On-State Resistance	$V_{GS} = 10 V, I_D = 1 A$	$R_{DS(on)}$	-	2.2	2.55	Ω
Forward Transconductance	$V_{DS} = 15 V, I_D = 2 A$	g_{fs}	-	3.5	-	S
Input Capacitance	$V_{GS} = 0 V, V_{DS} = 2 V, f = 200KHz$	C_{iss}	-	715	-	pF
Output Capacitance		C_{oss}	-	65	-	pF
Reverse Transfer Capacitance		C_{rss}	-	10	-	pF
Turn-on Delay Time(Note2)	$I_D = 4 A, V_{DD} = 400 V, R_G = 25 \Omega$	$t_{d(ON)}$	-	12	-	ns
Rise Time(Note2)		t_r	-	22	-	ns
Turn-Off Delay Time(Note2)		$t_{d(OFF)}$	-	50	-	ns
Fall Time(Note2)		t_f	-	48	-	ns
Total Gate Charge(Note2)	$I_D = 4 A, V_{DD} = 520 V, V_{GS} = 10 V$	Q_G	-	15	-	nC
Gate to Source Charge(Note2)		Q_{GS}	-	2.5	-	nC
Gate to Drain Charge(Note2)		Q_{GD}	-	7.5	-	nC

Source-Drain Diode Characteristics at Ta=25°C unless otherwise specified

Characteristics	Test Condition	Symbol	Min.	Typ.	Max.	Unit
Maximun Body-Diode Continuous Current		I_S	-	-	4	A
Maximun Body-Diode Pulsed Current(Note2)		I_{SM}	-	-	20	A
Drain-Source Diode Forward Voltage	$I_{SD} = 1 A$	V_{SD}	-	-	0.9	V
Reverse Recovery Time(Note2)	$I_{SD} = 4 A, V_{GS} = 0 V, dI / dt = 100 A / \mu s$	t_{rr}	-	430	-	ns
Reverse Recovery Charge(Note2)		Q_{rr}	-	1.27	-	μC

Note2:Pulse test: 300 μs pulse width, 2 % duty cycle

RATINGS AND CHARACTERISTIC CURVES

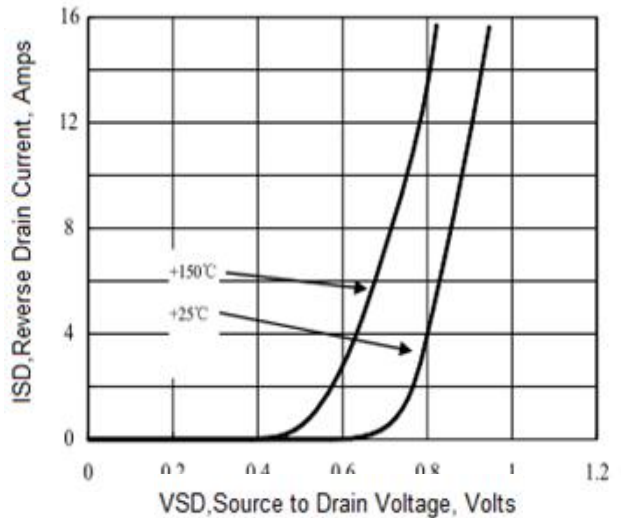
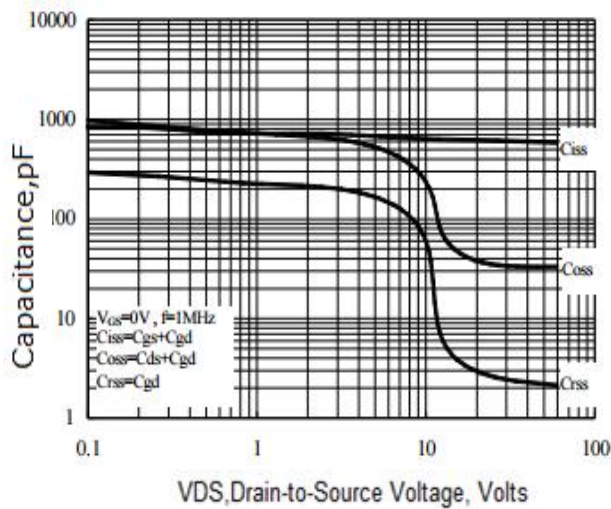
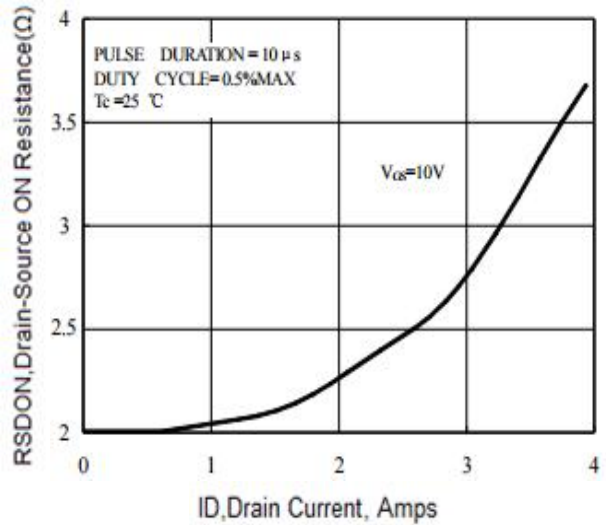
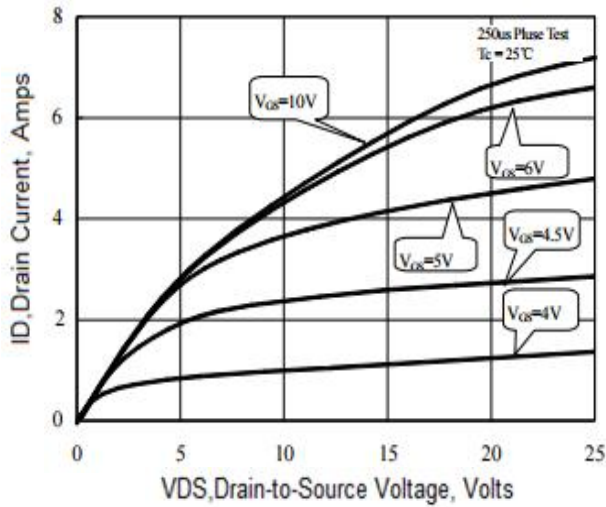
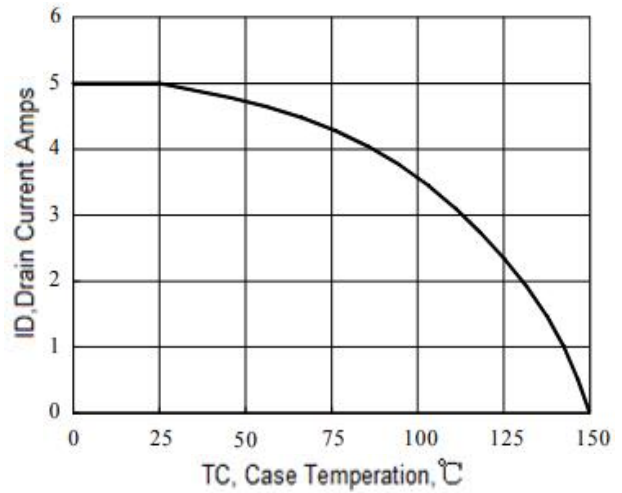
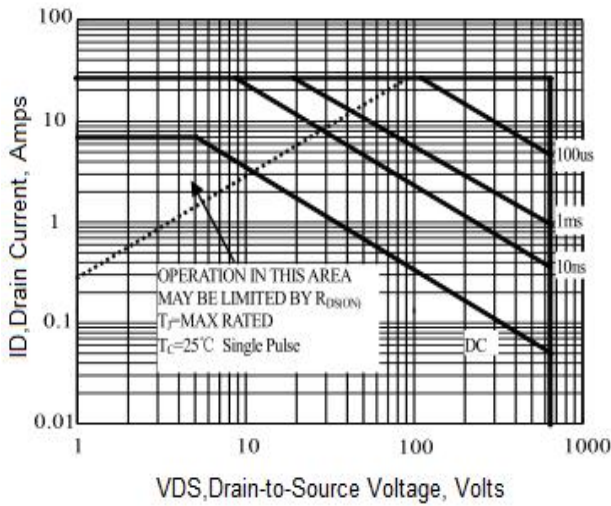

Package Outline Dimensions millimeters

T0-220F

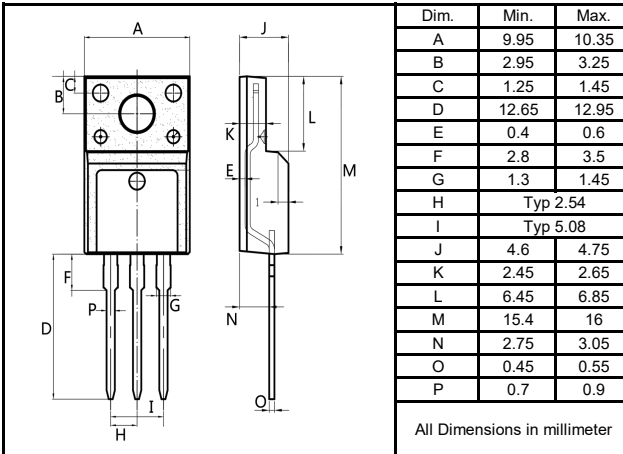

T0-220AB

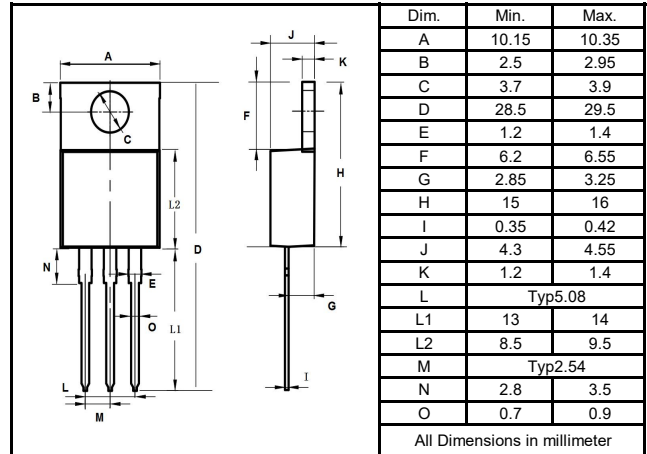

T0-263

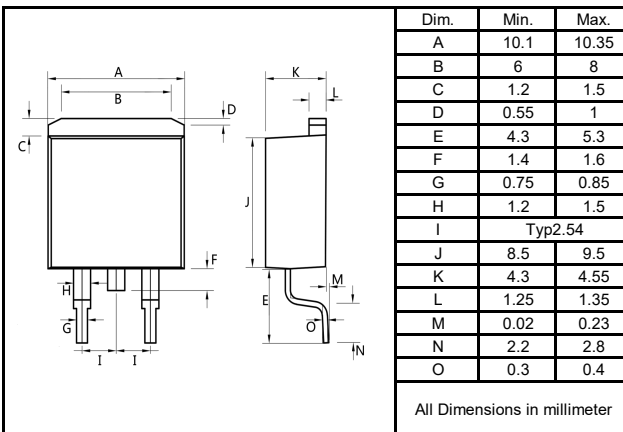

T0-252

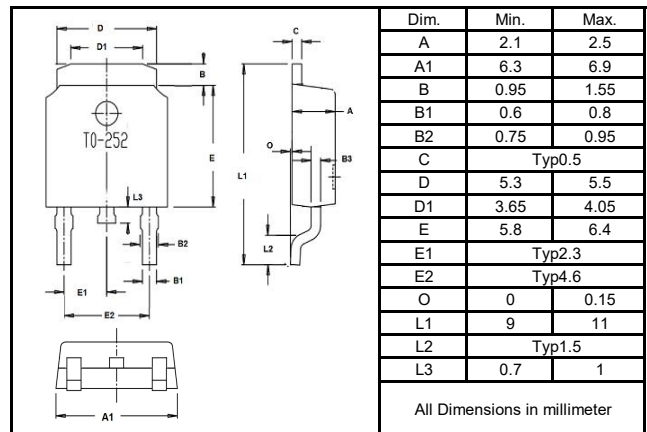



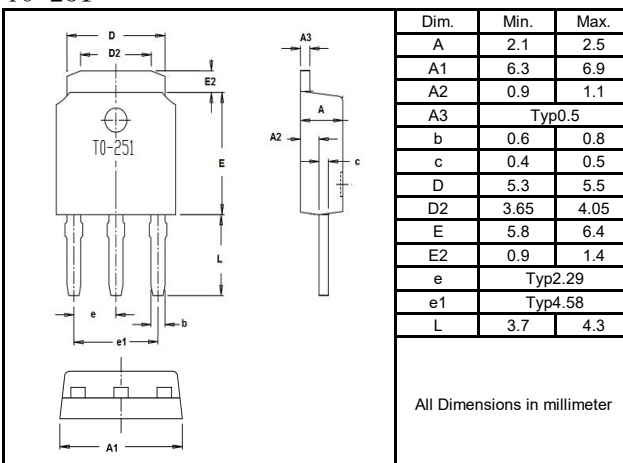



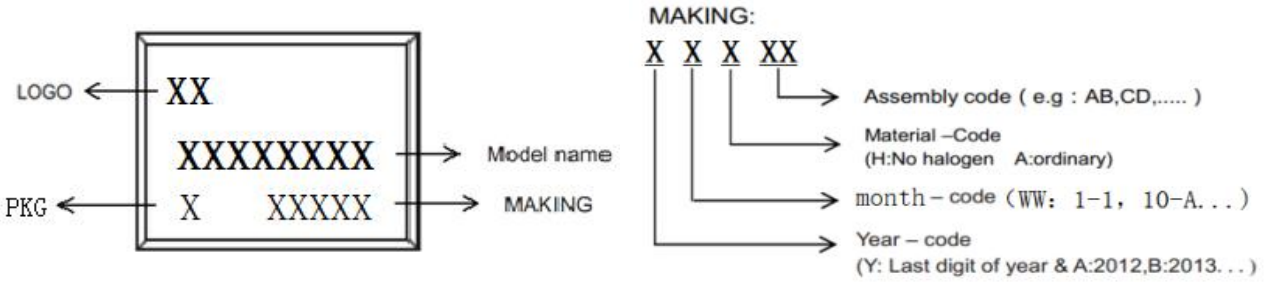





T0-251



Marking on the body



packing instruction

PKG	最小包装	内盒	外箱
TO-220F TO-220AB TO-263			
	50pcs/管	1000pcs/盒	5000pcs/箱
TO-252			
	2500pcs/盘	5000pcs/盒	25000pcs/箱
TO-263-R			
	800pcs/盘	1600pcs/盒	8000pcs/箱
TO-251			
	80pcs/管	4000pcs/盒	24000pcs/箱

Notice

All product, product specifications and data are subject to change without notice to improve. The right to explain is owned by LINGXUN company.

Confirm that operation temperature is within the specified range described in the product specification. Avoid applying power exceeding power; exceeding the power rating under steady-state loading condition may negatively affect product performance and reliability.

LINGXUN electronics shall not be in any way responsible or liable for failure induced under deviant condition from what is defined in