

Features

- Peak power dissipation
400W@10 x 1000 us Pluse
- Low incremental surge resistance
- Excellent clamping capability
- Fast response time
- Low leakage current
- Halogen free and RoHS compliant

Applications

- Personal digital assistants (PDA)
- Cellular handsets & Accessories
- Handhelds and notebooks
- Portable instrumentation

Mechanical Characteristics

- DO-214AC(SMA) surface mount package

Dimensions and Pin Configuration



DO-214AC(SMA)

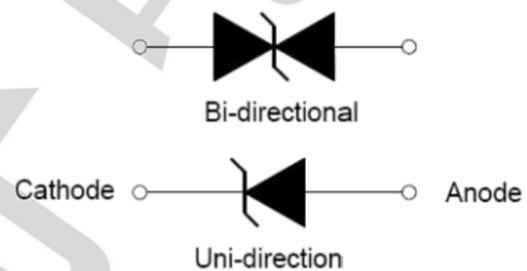

Pin Configuration

Maximum Ratings & Thermal Characteristics

(Tamb=25°C unless otherwise specified)

Parameter	Symbol	Value	Unit
Peak pulse power (tp=10/1000µs waveform)	P _{PPM}	400	W
Steady state power dissipation at T _A =50°C	P _{M(AV)}	3.0	W
Peak Pulse Current of on 10/1000us Waveform	I _{PPM}	See Table	A
Typical thermal resistance junction to ambient	R _{θJA}	120	°C/W
Storage & operating temperature range	T _{STG} , T _J	-55~+150	°C

Electrical Characteristics (TA=25°C unless otherwise specified)

MCC PART NUMBER		REVERSE STAND-OFF F VOLTAGE V_{WM}	BREAKDOWN VOLTAGE $V_{(BR)} @ I_T$ (VOLTS)			MAXIMUM CLAMPING VOLTAGE @ I_{PP}	PEAK PULSE CURRENT I_{PP}	MAXIMUM REVERSE LEAKAGE @ V_{WM} I_D
UNI-POLAR	BI-POLAR	(VOLTS)	MIN	MAX	I_T (mA)	(VOLTS)	(AMPS)	(μA)
TPSMAJ5.0A	TPSMAJ5.0CA	5.0	6.40	7.00	10	9.2	43.5	800
TPSMAJ6.0A	TPSMAJ6.0CA	6.0	6.67	7.37	10	10.3	38.8	800
TPSMAJ6.5A	TPSMAJ6.5CA	6.5	7.22	7.98	10	11.2	35.7	500
TPSMAJ7.0A	TPSMAJ7.0CA	7.0	7.78	8.60	10	12.0	33.3	200
TPSMAJ7.5A	TPSMAJ7.5CA	7.5	8.33	9.21	1	12.9	31.0	100
TPSMAJ8.0A	TPSMAJ8.0CA	8.0	8.89	9.83	1	13.6	29.4	50
TPSMAJ8.5A	TPSMAJ8.5CA	8.5	9.44	10.4	1	14.4	27.7	20
TPSMAJ9.0A	TPSMAJ9.0CA	9.0	10.0	11.1	1	15.4	26.0	10
TPSMAJ10A	TPSMAJ10CA	10	11.1	12.3	1	17.0	23.5	5
TPSMAJ11A	TPSMAJ11CA	11	12.2	13.5	1	18.2	22.0	1
TPSMAJ12A	TPSMAJ12CA	12	13.3	14.7	1	19.9	20.1	1
TPSMAJ13A	TPSMAJ13CA	13	14.4	15.9	1	21.5	18.6	1
TPSMAJ14A	TPSMAJ14CA	14	15.6	17.2	1	23.2	17.2	1
TPSMAJ15A	TPSMAJ15CA	15	16.7	18.5	1	24.4	16.4	1
TPSMAJ16A	TPSMAJ16CA	16	17.8	19.7	1	26.0	15.3	1
TPSMAJ17A	TPSMAJ17CA	17	18.9	20.9	1	27.6	14.5	1
TPSMAJ18A	TPSMAJ18CA	18	20.0	22.1	1	29.2	13.7	1
TPSMAJ20A	TPSMAJ20CA	20	22.2	24.5	1	32.4	12.3	1
TPSMAJ22A	TPSMAJ22CA	22	24.4	26.9	1	35.5	11.2	1
TPSMAJ24A	TPSMAJ24CA	24	26.7	29.5	1	38.9	10.3	1
TPSMAJ26A	TPSMAJ26CA	26	28.9	31.9	1	42.1	9.5	1
TPSMAJ28A	TPSMAJ28CA	28	31.1	34.4	1	45.4	8.8	1
TPSMAJ30A	TPSMAJ30CA	30	33.3	36.8	1	48.4	8.3	1
TPSMAJ33A	TPSMAJ33CA	33	36.7	40.6	1	53.3	7.5	1
TPSMAJ36A	TPSMAJ36CA	36	40.0	44.2	1	58.1	6.9	1
TPSMAJ40A	TPSMAJ40CA	40	44.4	49.1	1	64.5	6.2	1
TPSMAJ43A	TPSMAJ43CA	43	47.8	52.8	1	69.4	5.7	1
TPSMAJ45A	TPSMAJ45CA	45	50.0	55.3	1	72.7	5.5	1
TPSMAJ48A	TPSMAJ48CA	48	53.3	58.9	1	77.4	5.2	1

Electrical Characteristics (TA=25°C unless otherwise specified)

MCC PART NUMBER		REVERSE STAND-OFF VOLTAGE V_{WM}	BREAKDOWN VOLTAGE $V_{(BR)}$ @ I_T (VOLTS)			MAXIMUM CLAMPING VOLTAGE @ I_{PP}	PEAK PULSE CURRENT I_{PP}	MAXIMUM REVERSE LEAKAGE @ V_{WM} I_D
UNI-POLAR	BI-POLAR	(VOLTS)	MIN	MAX	I_T (mA)	(VOLTS)	(AMPS)	(μA)
TPSMAJ51A	TPSMAJ51CA	51	56.7	62.7	1	82.4	4.9	1
TPSMAJ54A	TPSMAJ54CA	54	60.0	66.3	1	87.1	4.6	1
TPSMAJ58A	TPSMAJ58CA	58	64.4	71.2	1	93.6	4.3	1
TPSMAJ60A	TPSMAJ60CA	60	66.7	73.7	1	96.8	4.1	1
TPSMAJ64A	TPSMAJ64CA	64	71.1	78.6	1	103	3.9	1
TPSMAJ70A	TPSMAJ70CA	70	77.8	86.0	1	113	3.5	1
TPSMAJ75A	TPSMAJ75CA	75	83.3	92.1	1	121	3.3	1
TPSMAJ78A	TPSMAJ78CA	78	86.7	95.8	1	126	2.2	1
TPSMAJ85A	TPSMAJ85CA	85	94.4	104	1	137	2.9	1
TPSMAJ90A	TPSMAJ90CA	90	100	111	1	146	2.7	1
TPSMAJ100A	TPSMAJ100CA	100	111	123	1	162	2.5	1
TPSMAJ110A	TPSMAJ110CA	110	122	135	1	177	2.3	1
TPSMAJ120A	TPSMAJ120CA	120	133	147	1	193	2.1	1
TPSMAJ130A	TPSMAJ130CA	130	144	159	1	209	1.9	1
TPSMAJ150A	TPSMAJ150CA	150	167	185	1	243	1.6	1
TPSMAJ160A	TPSMAJ160CA	160	178	197	1	259	1.5	1
TPSMAJ170A	TPSMAJ170CA	170	189	209	1	275	1.5	1
TPSMAJ180A	TPSMAJ180CA	180	201	222	1	292	1.4	1
TPSMAJ200A	TPSMAJ200CA	200	224	247	1	324	1.2	1
TPSMAJ220A	TPSMAJ220CA	220	246	272	1	356	1.1	1
TPSMAJ250A	TPSMAJ250CA	250	279	309	1	405	1.0	1
TPSMAJ300A	TPSMAJ300CA	300	335	371	1	486	0.8	1
TPSMAJ350A	TPSMAJ350CA	350	391	432	1	567	0.7	1
TPSMAJ400A	TPSMAJ400CA	400	447	494	1	648	0.6	1
TPSMAJ440A	TPSMAJ440CA	440	492	543	1	713	0.6	1

For bi-directional type having V_{wm} of 10 Volts and less, the IR limit is double.

For parts without A, the VBR is +10%.

Typical Characteristics Curves

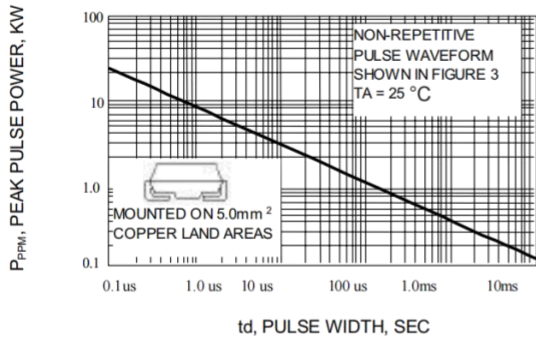

Fig. 1-PEAK PULSE POWER RATING CURVE

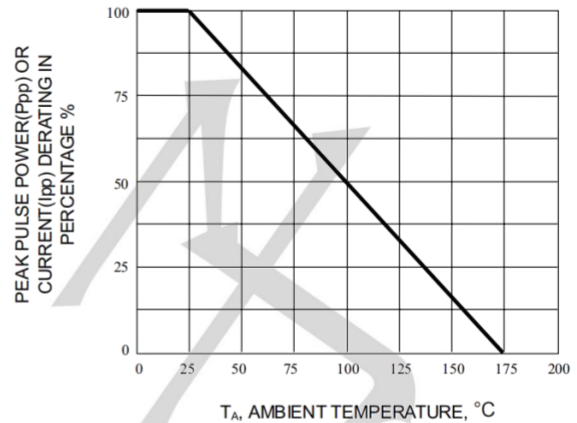

Fig. 2-PULSE RATING CURVE

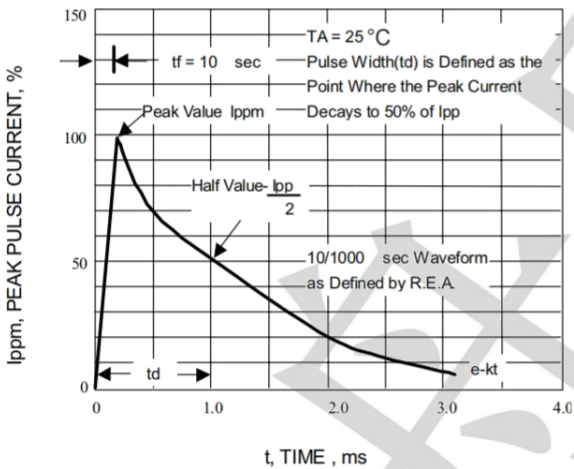

Fig. 3-PULSE WAVEFORM

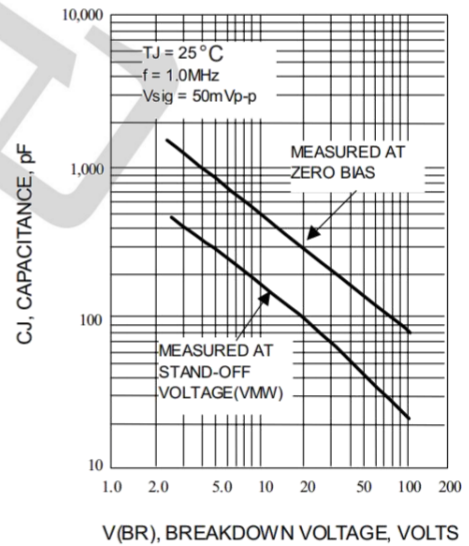

Fig. 4-TYPICAL JUNCTION CAPACITANCE

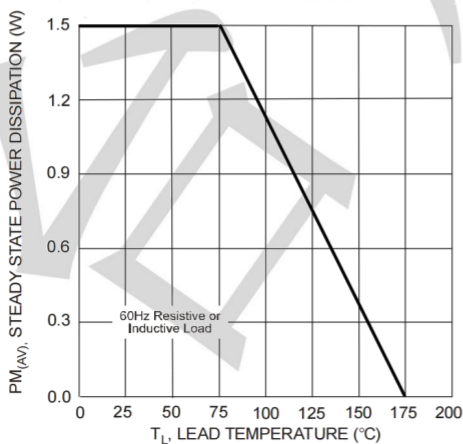
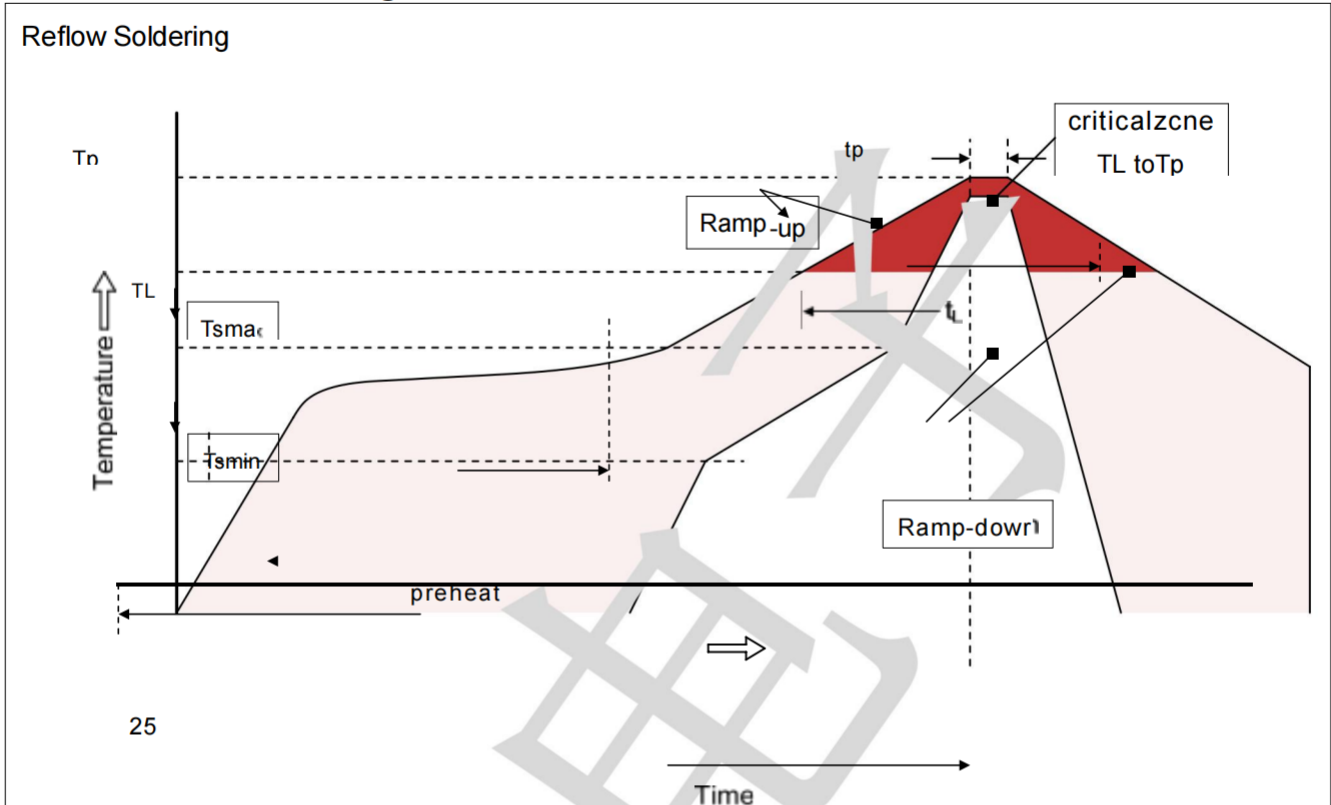

Fig. 5-Steady State Power Derating Curve

Recommended Soldering Conditions



Recommended Conditions

Profile Feature	Pb-Free Assembly
Average ramp-up rate (T_L to T_P)	3°C/second max.
Preheat	
-Temperature Min (T_{Smin})	150°C
-Temperature Max (T_{Smax})	200°C
-Time (min to max) (t_s)	60-180 seconds
T_{Smax} to T_L	
-Ramp-up Rate	3°C/second max.
Time maintained above:	
-Temperature (T_L)	217°C
-Time (t_L)	60-150 seconds
Peak Temperature (T_P)	260°C
Time within 5°C of actual Peak Temperature (t_p)	20-40 seconds
Ramp-down Rate	6°C/second max.
Time 25°C to Peak Temperature	8 minutes max.

Package Outline Dimensions (unit: mm)

SMA

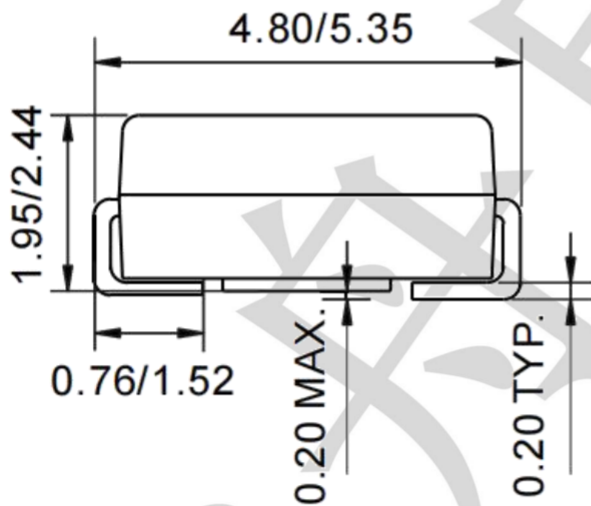
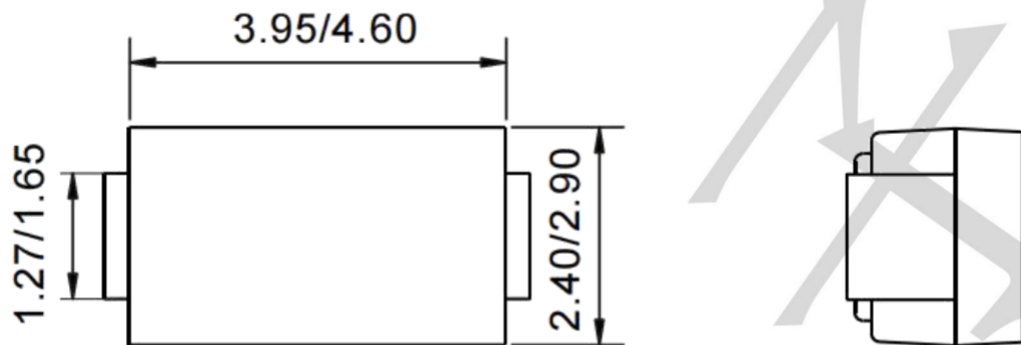

Mounting Pad Layout (unit: mm)

