



## SGM4871 2.4W Audio Power Amplifier with Shutdown Mode

---

### GENERAL DESCRIPTION

The SGM4871 is a mono bridged audio power amplifier that is designed for portable communication device applications and demanding applications in mobile phones. SGM4871YPS8 is capable of delivering 2.4W of continuous average power into a 4Ω load with typically 10% distortion (THD+N) from a 5V battery voltage. It operates from 2.5V to 5.5V power supply.

The SGM4871's micro-power shutdown mode ( $I_{SD} = 0.07\mu\text{A}$  TYP) is activated when  $V_+$  is applied to the SHDN pin. Since the SGM4871 does not require output coupling capacitors, bootstrap capacitors, or snubber networks, it is ideally suited for low power portable systems that require minimum volume and weight.

The SGM4871 is unity-gain stable and can be configured by external gain-setting resistors. Additionally, the SGM4871 features an internal thermal shutdown protection mechanism.

The SGM4871 is available in Green SOIC-8 and SOIC-8 (Exposed Pad) packages. It operates over an ambient temperature range of -40°C to +85°C.

### FEATURES

- **Output Power at THD+N = 10%, 1kHz**  
**SGM4871YPS8: 2.4W (TYP) into 4Ω Load**  
**SGM4871YS8: 1.5W (TYP) into 8Ω Load**
- **Unity Gain Stable**
- **2.5V to 5.5V Operation**
- **Shutdown Current: 0.07μA (TYP)**
- **Thermal Overload Protection Circuitry**
- **No Output Coupling Capacitors, Bootstrap Capacitors or Snubber Networks Required**
- **External Gain Configuration Capability**
- **-40°C to +85°C Operating Temperature Range**
- **Available in Green SOIC-8 (Exposed Pad) and SOIC-8 Packages**

### APPLICATIONS

Portable Systems  
Wireless Handsets  
Mobile Phone  
PDAs

# SGM4871

# 2.4W Audio Power Amplifier with Shutdown Mode

## PACKAGE/ORDERING INFORMATION

MODEL	ORDER NUMBER	PACKAGE DESCRIPTION	PACKAGE OPTION	MARKING INFORMATION
SGM4871	SGM4871YPS8/TR	SOIC-8 (Exposed Pad)	Tape and Reel, 2500	SGM4871YPS8
	SGM4871YS8/TR	SOIC-8	Tape and Reel, 2500	SGM4871YS8

## ABSOLUTE MAXIMUM RATINGS

Supply Voltage .....	5.5V
Input Voltage.....	-0.1V to (V <sub>+</sub> ) + 0.1V
Storage Temperature Range.....	-65°C to +150°C
Junction Temperature .....	150°C
Operating Temperature Range.....	-40°C to +85°C
Lead Temperature Range (Soldering 10 sec) .....	260°C
ESD Susceptibility	
HBM.....	2000V
MM.....	200V

### NOTE:

Stresses beyond those listed under “Absolute Maximum Ratings” may cause permanent damage to the device. These are stress ratings only, and functional operation of the device at these or any other conditions beyond those indicated in the operational sections of the specifications is not implied. Exposure to absolute maximum rating conditions for extended periods may affect device reliability.

## CAUTION

This integrated circuit can be damaged by ESD if you don't pay attention to ESD protection. SGMICRO recommends that all integrated circuits be handled with appropriate precautions. Failure to observe proper handling and installation procedures can cause damage. ESD damage can range from subtle performance degradation to complete device failure. Precision integrated circuits may be more susceptible to damage because very small parametric changes could cause the device not to meet its published specifications.

SGMICRO reserves the right to make any change in circuit design, specification or other related things if necessary without notice at any time. Please contact SGMICRO sales office to get the latest datasheet.

## PIN CONFIGURATIONS (TOP VIEW)

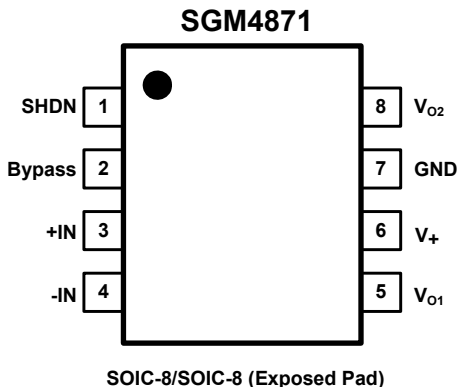

**ELECTRICAL CHARACTERISTICS**(The following specifications apply for  $T_A = +25^\circ\text{C}$ ,  $V_+ = 5\text{V}$  and  $R_L = 8\Omega$ , unless otherwise specified.)

PARAMETER	SYMBOL	CONDITIONS		MIN	TYP	MAX	UNITS
Supply Voltage	$V_+$			2.5		5.5	V
Output Offset Voltage	$V_{OS}$				5.5	65	mV
Quiescent Power Supply Current	$I_Q$	$V_{SHDN} = \text{GND}$	No Load		5.2	9	mA
			$R_L = 8\Omega$		5.3		
Shutdown Current	$I_{SD}$	$V_+ = 5.0\text{V}$ , $V_{SHDN} = 5.0\text{V}$ , $I_O = 0\text{mA}$			0.07	2	$\mu\text{A}$
Shutdown Voltage Input High	$V_{SDIH}$			1.2			V
Shutdown Voltage Input Low	$V_{SDIL}$					0.4	
Output Power (4 $\Omega$ )	$P_O$	$f = 1\text{kHz}$ , THD+N = 1%			1.9		W
		$f = 1\text{kHz}$ , THD+N = 10%			2.4		W
Output Power (8 $\Omega$ )	$P_O$	$f = 1\text{kHz}$ , THD+N = 1%			1.2		W
		$f = 1\text{kHz}$ , THD+N = 10%			1.5		W
Total Harmonic Distortion + Noise	THD+N	20Hz < $f$ < 20kHz, $R_L = 8\Omega$ , $P_O = 1\text{W}$			0.2		%
Power Supply Rejection Ratio	PSRR	$V_{SHDN} = \text{GND}$ , $V_+ = 4.9\text{V}$ to $5.1\text{V}$			70		dB

TYPICAL PERFORMANCE CHARACTERISTICS (SGM4871YS8)

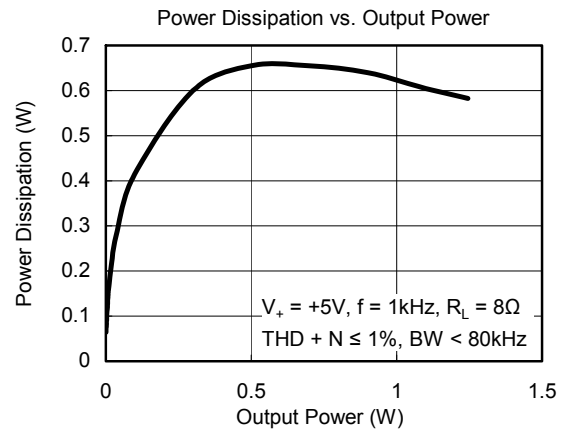
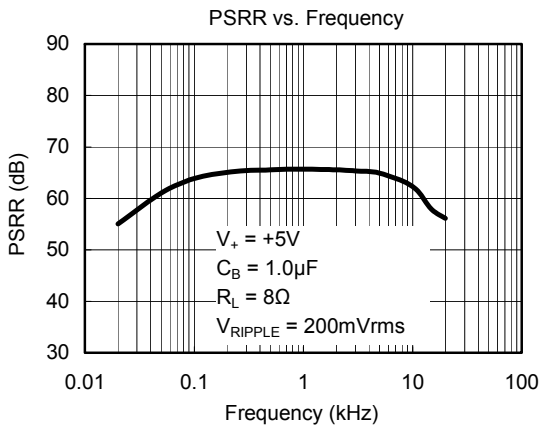
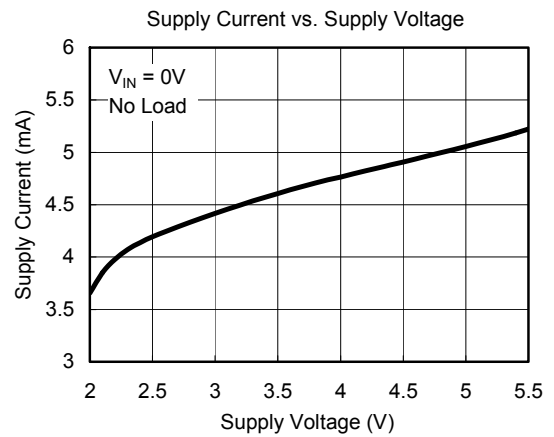
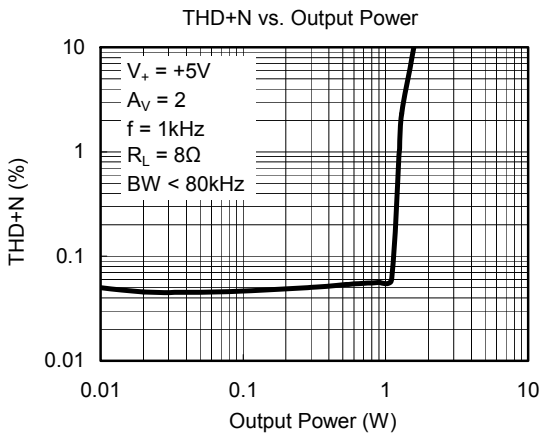
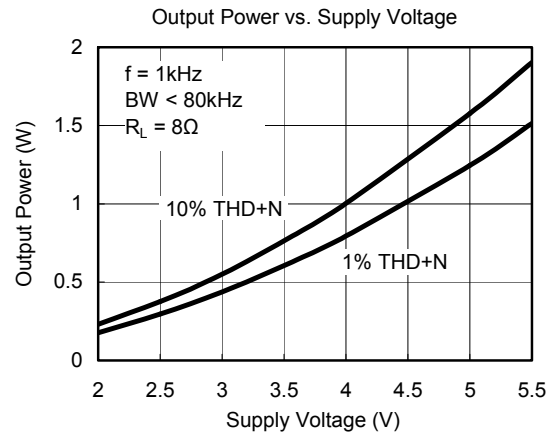
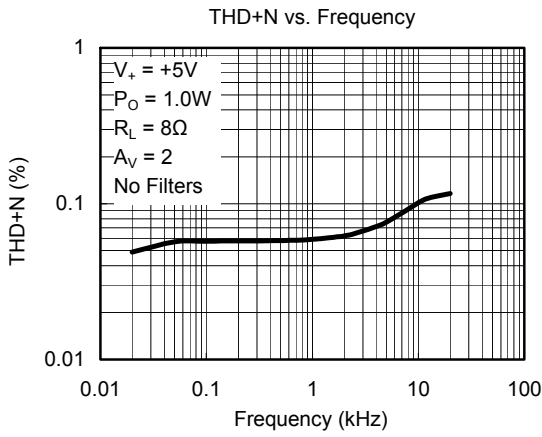

TYPICAL PERFORMANCE CHARACTERISTICS (SGM4871YPS8)

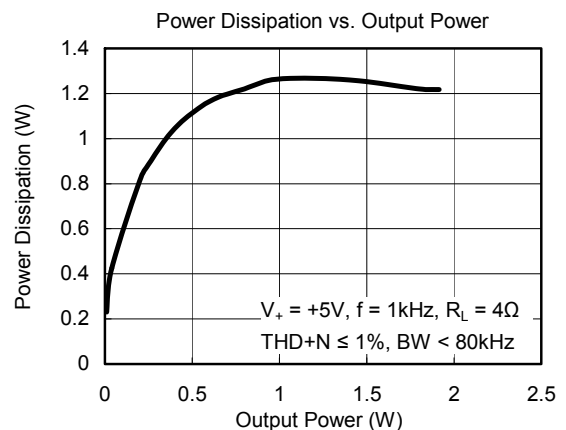
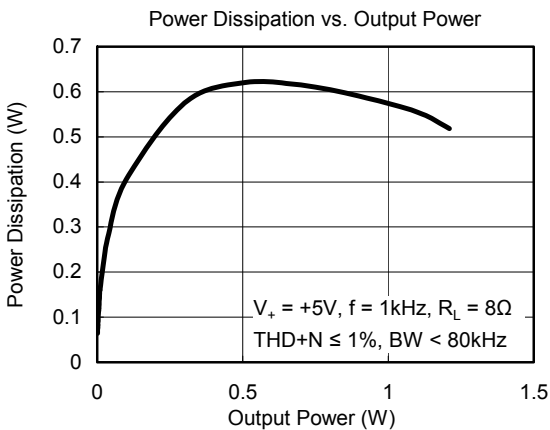
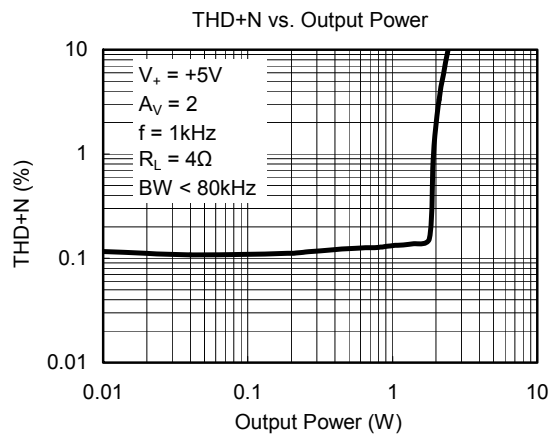
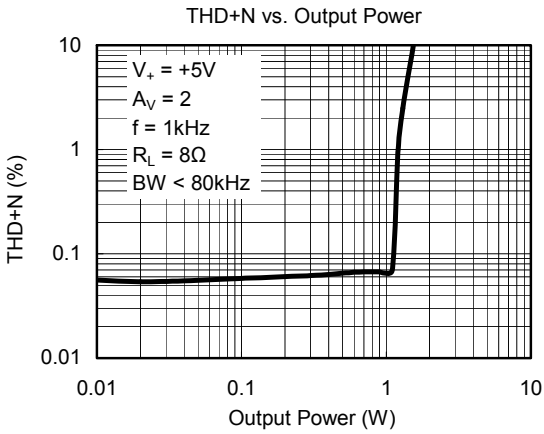
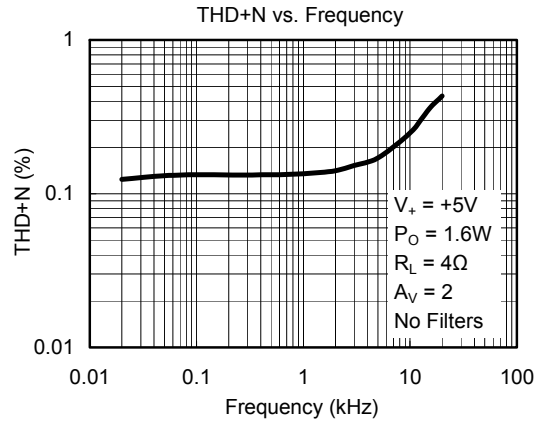
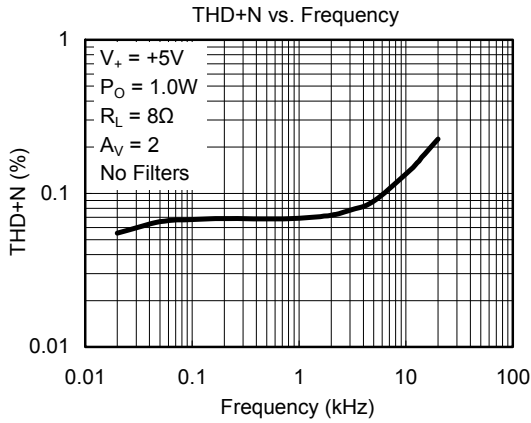

TYPICAL PERFORMANCE CHARACTERISTICS (SGM4871YPS8)

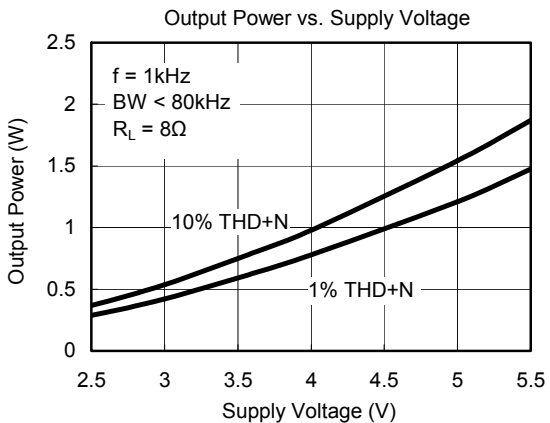
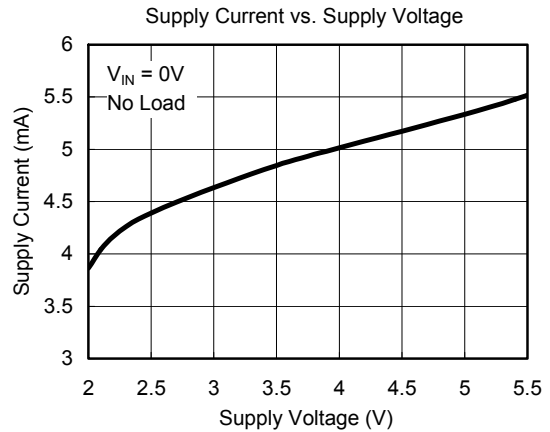
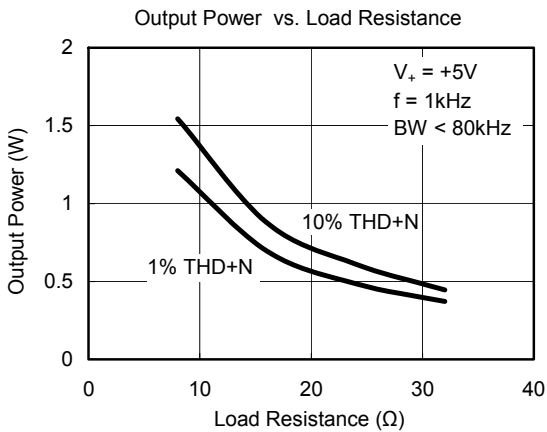
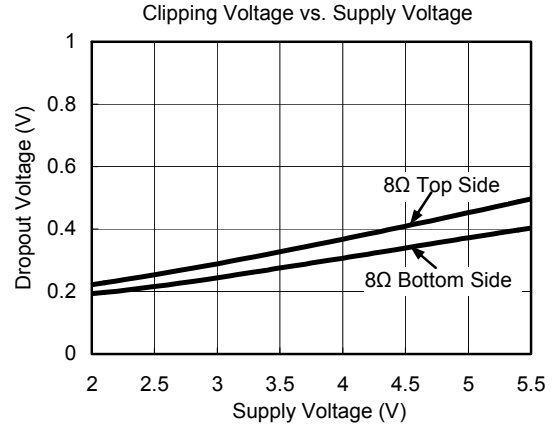
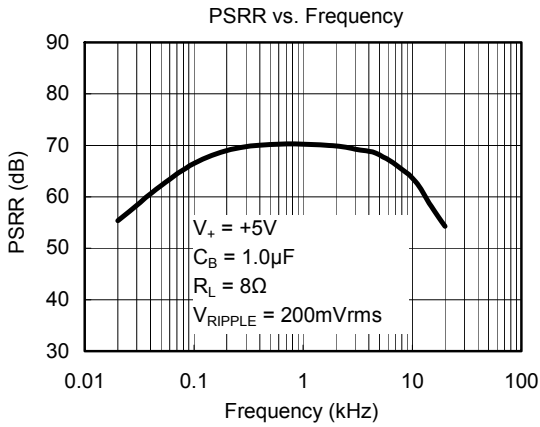

TYPICAL APPLICATION

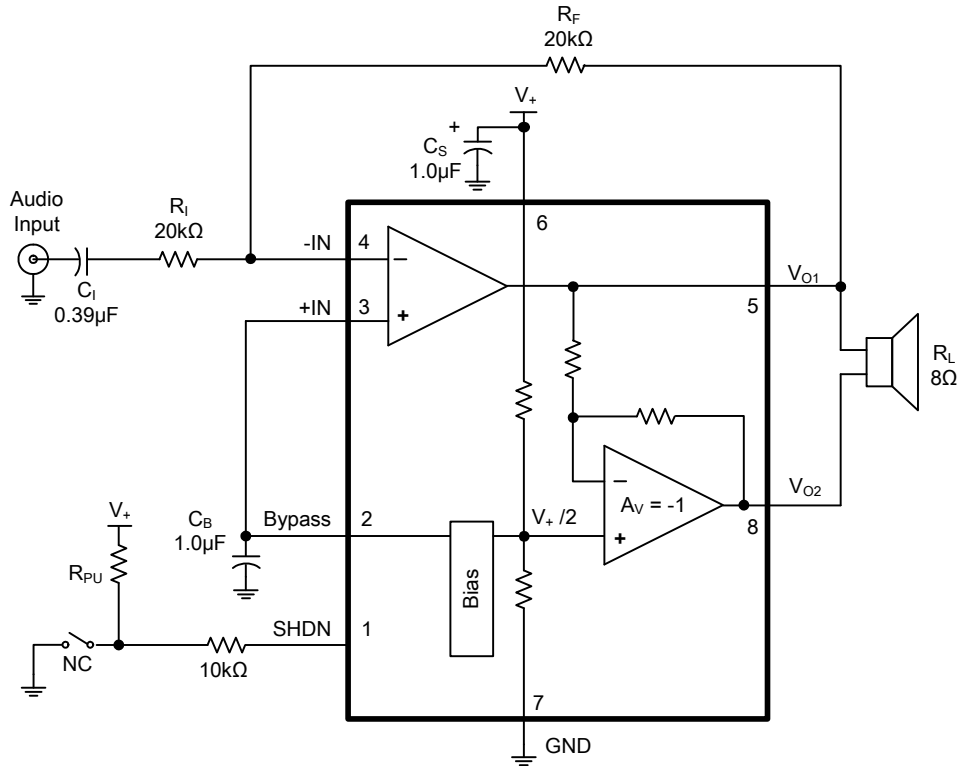

NOTE:  
 1. A 10kΩ resistor must be serially connected to SHDN pin.

## APPLICATION NOTES

### PCB Design Recommendations (Thermal Design Considerations)

With proper thermal design considerations, SGM4871YPS8 is capable of delivering 2.4W of continuous average power into a 4Ω load.

#### Thermal Land

The SOIC-8 (Exposed Pad) thermal land is a metal (normally copper) region centrally located under the package and on top of the PCB. It has a rectangular or square shape and should match the dimensions of the exposed pad on the bottom of the package (1:1 ratio).

For certain high power applications, the PCB land may be modified to a "dog bone" shape that enhances thermal performance. The packages used with the "dog bone" lands will be a dual inline configuration (see Figure 1).

Top View

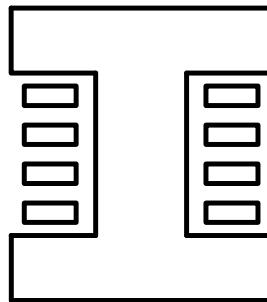

Figure 1. Dog Bone

#### Thermal Vias

Thermal vias are necessary. They conduct heat from the exposed pad of the package to the ground plane. The number of vias is application specific and is dependent upon electrical requirements and power dissipation.

The via diameter should be 0.2mm to 0.33mm with 1oz. copper via barrel plating. It is important to plug the via to avoid any solder wicking inside the via during the soldering process. The thermal vias can be tented with solder mask on the top surface of the PCB. The solder mask diameter should be at least 75microns (or 3mils) larger than the via diameter. The solder mask thickness should be the same across the entire PCB.

A package thermal performance may be improved by increasing the number of vias.



PACKAGE OUTLINE DIMENSIONS

SOIC-8

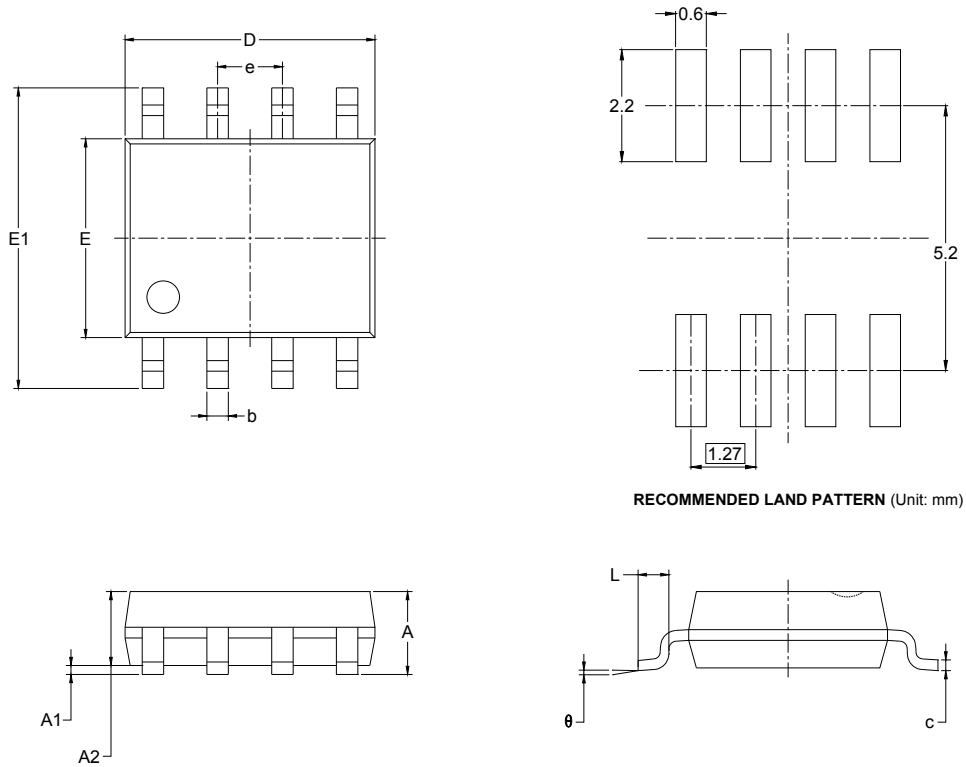

RECOMMENDED LAND PATTERN (Unit: mm)

Symbol	Dimensions In Millimeters		Dimensions In Inches	
	MIN	MAX	MIN	MAX
A	1.350	1.750	0.053	0.069
A1	0.100	0.250	0.004	0.010
A2	1.350	1.550	0.053	0.061
b	0.330	0.510	0.013	0.020
c	0.170	0.250	0.006	0.010
D	4.700	5.100	0.185	0.200
E	3.800	4.000	0.150	0.157
E1	5.800	6.200	0.228	0.244
e	1.27 BSC		0.050 BSC	
L	0.400	1.270	0.016	0.050
$\theta$	0°	8°	0°	8°

## PACKAGE OUTLINE DIMENSIONS

## SOIC-8 (Exposed Pad)

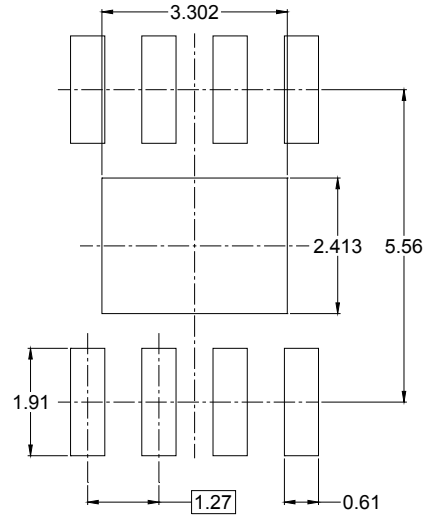
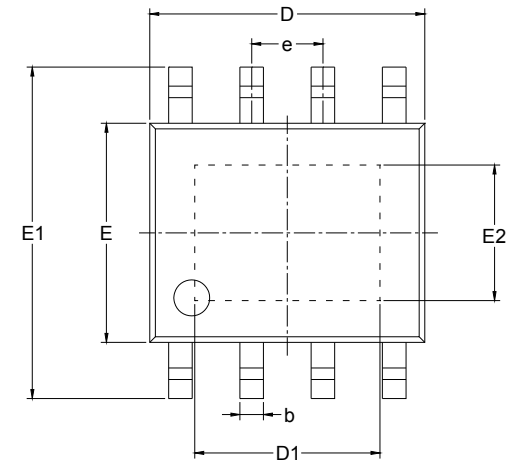

RECOMMENDED LAND PATTERN (Unit: mm)

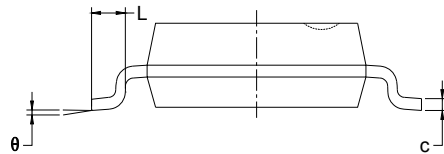
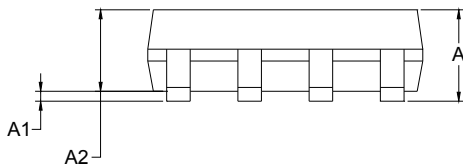

Symbol	Dimensions In Millimeters		Dimensions In Inches	
	MIN	MAX	MIN	MAX
A		1.700		0.067
A1	0.000	0.100	0.000	0.004
A2	1.350	1.550	0.053	0.061
b	0.330	0.510	0.013	0.020
c	0.170	0.250	0.007	0.010
D	4.700	5.100	0.185	0.201
D1	3.202	3.402	0.126	0.134
E	3.800	4.000	0.150	0.157
E1	5.800	6.200	0.228	0.244
E2	2.313	2.513	0.091	0.099
e	1.27 BSC		0.050 BSC	
L	0.400	1.270	0.016	0.050
$\theta$	0°	8°	0°	8°

**TAPE AND REEL INFORMATION**

**REEL DIMENSIONS**

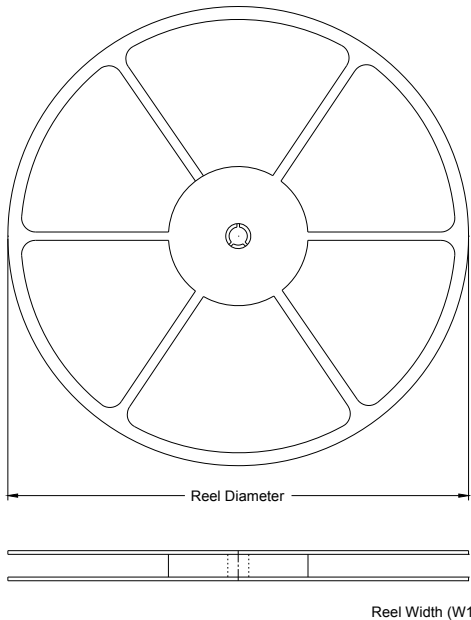

**TAPE DIMENSIONS**

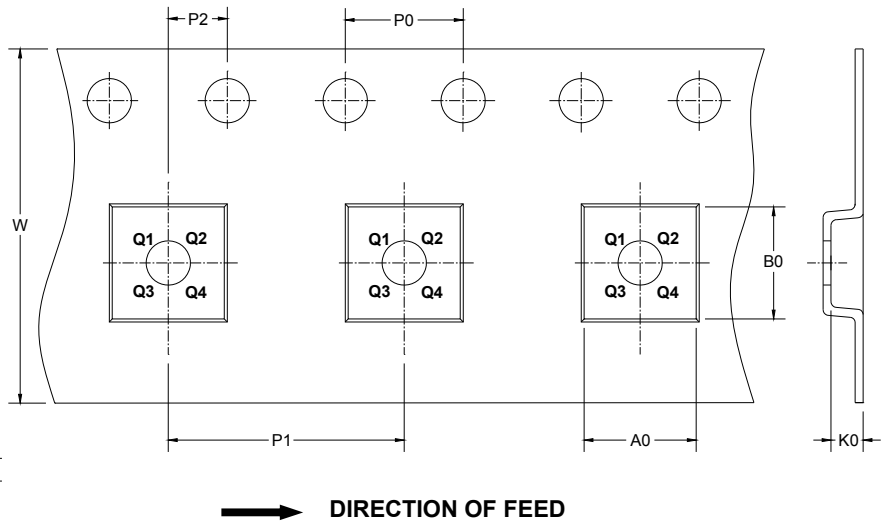

NOTE: The picture is only for reference. Please make the object as the standard.

**KEY PARAMETER LIST OF TAPE AND REEL**

Package Type	Reel Diameter	Reel Width W1 (mm)	A0 (mm)	B0 (mm)	K0 (mm)	P0 (mm)	P1 (mm)	P2 (mm)	W (mm)	Pin1 Quadrant
SOIC-8	13"	12.4	6.4	5.4	2.1	4.0	8.0	2.0	12.0	Q1
SOIC-8 (Exposed Pad)	13"	12.4	6.4	5.4	2.1	4.0	8.0	2.0	12.0	Q1

# SGM4871

# 2.4W Audio Power Amplifier with Shutdown Mode

## CARTON BOX DIMENSIONS

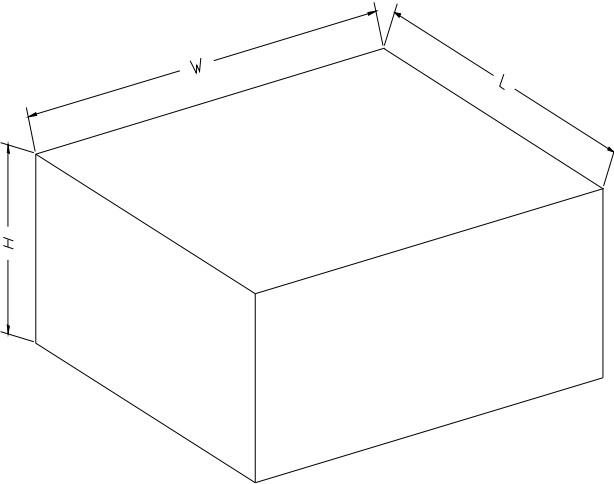

NOTE: The picture is only for reference. Please make the object as the standard.

## KEY PARAMETER LIST OF CARTON BOX

Reel Type	Length (mm)	Width (mm)	Height (mm)	Pizza/Carton
13"	386	280	370	5