

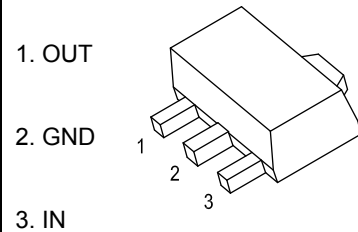

### FEATURES

- Maximum output current  
 $I_{OM}$ : 0.1A
- Output voltage  
 $V_O$ : 5V
- Continuous total dissipation  
 $P_D$ : 0.6 W ( $T_a = 25^\circ\text{C}$ )

### SOT-89-3L



### ABSOLUTE MAXIMUM RATINGS (Operating temperature range applies unless otherwise specified)

Parameter	Symbol	Value	Unit
Input Voltage	$V_i$	30	V
Thermal Resistance from Junction to Ambient	$R_{\theta JA}$	160	$^\circ\text{C/W}$
Operating Junction Temperature Range	$T_{OPR}$	-40~+125	$^\circ\text{C}$
Storage Temperature Range	$T_{STG}$	-65~+150	$^\circ\text{C}$

### ELECTRICAL CHARACTERISTICS AT SPECIFIED VIRTUAL JUNCTION TEMPERATURE ( $V_i=10\text{V}, I_o=40\text{mA}, C_i=0.33\mu\text{F}, C_o=0.1\mu\text{F}$ , unless otherwise specified)

Parameter	Symbol	Test conditions	Min	Typ	Max	Unit	
Output voltage	$V_o$		25 $^\circ\text{C}$	4.80	5.0	5.20	V
				4.85	5.0	5.15	V
		$7\text{V} \leq V_i \leq 20\text{V}, I_o = 1\text{mA} \sim 40\text{mA}$	0-125 $^\circ\text{C}$	4.90	5.0	5.10	V
				4.75	5.0	5.25	V
Load Regulation	$\Delta V_o$	$I_o = 1\text{mA} \sim 100\text{mA}$	25 $^\circ\text{C}$	15	60	mV	
		$I_o = 1\text{mA} \sim 40\text{mA}$	25 $^\circ\text{C}$	8	30	mV	
Line regulation	$\Delta V_o$	$7\text{V} \leq V_i \leq 20\text{V}$	0-125 $^\circ\text{C}$	32	150	mV	
		$8\text{V} \leq V_i \leq 20\text{V}$	25 $^\circ\text{C}$	26	100	mV	
Quiescent Current	$I_q$		25 $^\circ\text{C}$	3.8	6	mA	
Quiescent Current Change	$\Delta I_q$	$8\text{V} \leq V_i \leq 20\text{V}$	0-125 $^\circ\text{C}$		1.5	mA	
		$1\text{mA} \leq I_i \leq 40\text{mA}$	0-125 $^\circ\text{C}$		0.1		
Output Noise Voltage	$V_N$	$10\text{Hz} \leq f \leq 100\text{KHz}$	25 $^\circ\text{C}$	42		$\mu\text{V}/V_o$	
Ripple Rejection	RR	$8\text{V} \leq V_i \leq 20\text{V}, f = 120\text{Hz}$	0-125	41	49	dB	
Dropout Voltage	$V_d$		25 $^\circ\text{C}$	1.7		V	

\* Pulse test.

### TYPICAL APPLICATION

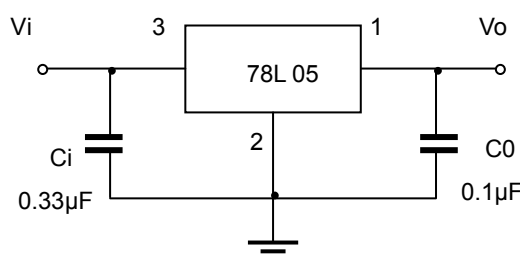

Note: Bypass capacitors are recommended for optimum stability and transient response and should be located as close as possible to the regulators.

# 78L05 SOT-89-3L

**Output Characteristics**

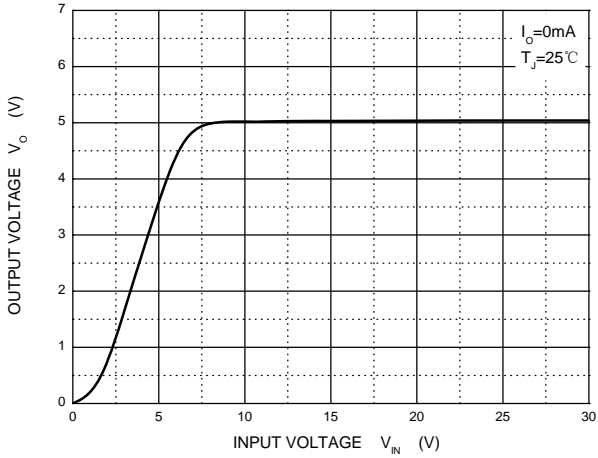

**Dropout Characteristics**

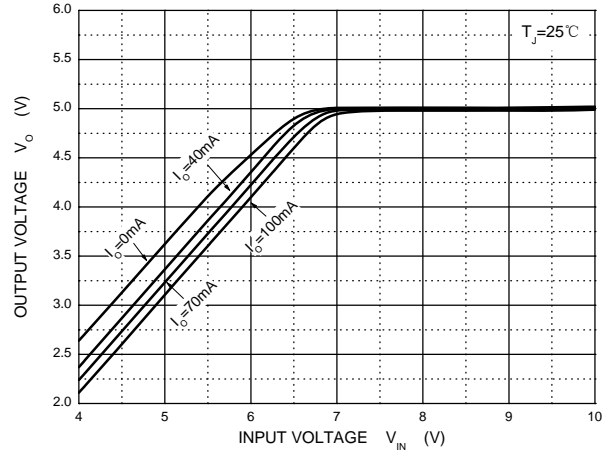

**Quiescent Current vs Input Voltage**

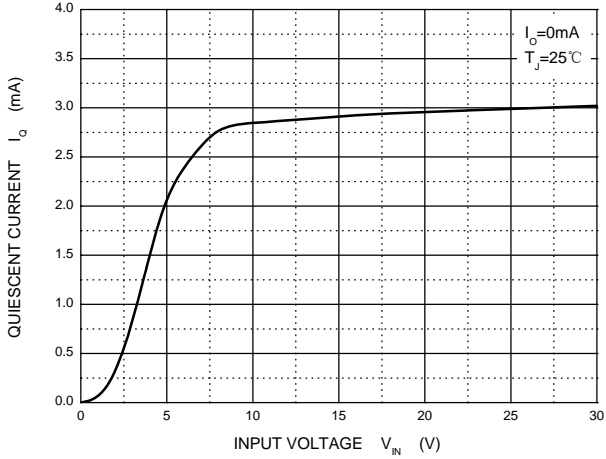

**Current Cut-off Grid Voltage**

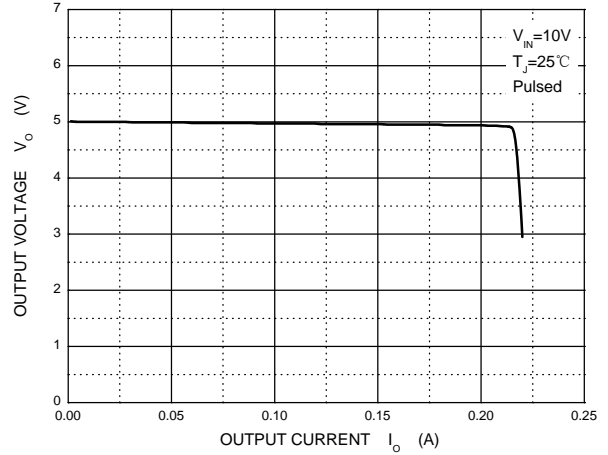

**Output Voltage vs Junction Temperature**

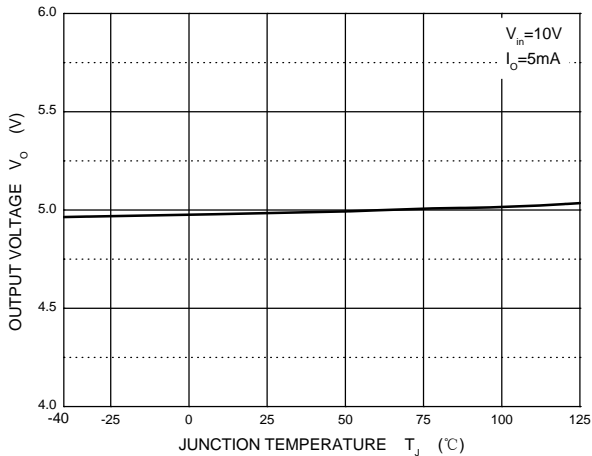

**Power Derating Curve**

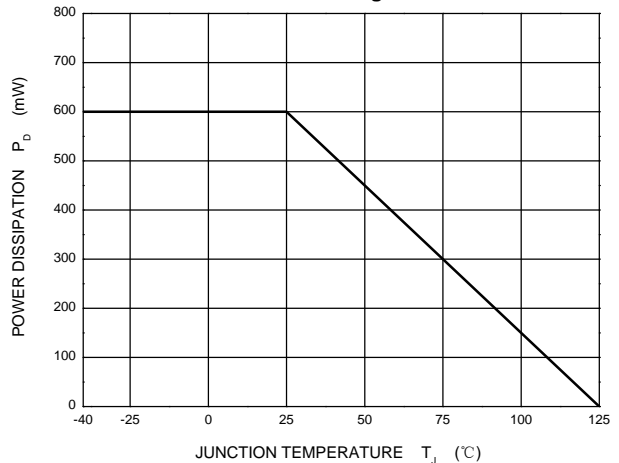

## SOT-89-3L Package Outline Dimensions

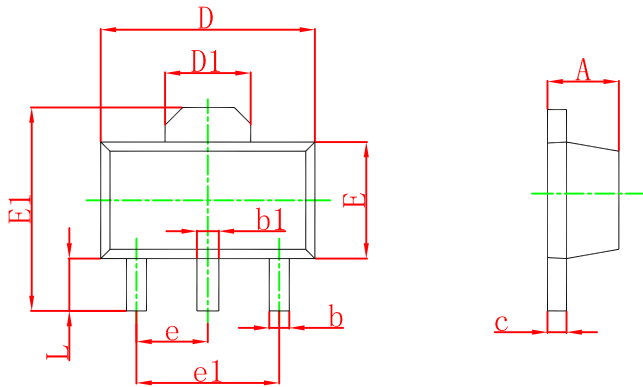

Symbol	Dimensions In Millimeters		Dimensions In Inches	
	Min	Max	Min	Max
A	1.400	1.600	0.055	0.063
b	0.320	0.520	0.013	0.020
b1	0.400	0.580	0.016	0.023
c	0.350	0.440	0.014	0.017
D	4.400	4.600	0.173	0.181
D1	1.550 REF.		0.061 REF.	
E	2.300	2.600	0.091	0.102
E1	3.940	4.250	0.155	0.167
e	1.500 TYP.		0.060 TYP.	
e1	3.000 TYP.		0.118 TYP.	
L	0.900	1.200	0.035	0.047

## SOT-89-3L Suggested Pad Layout

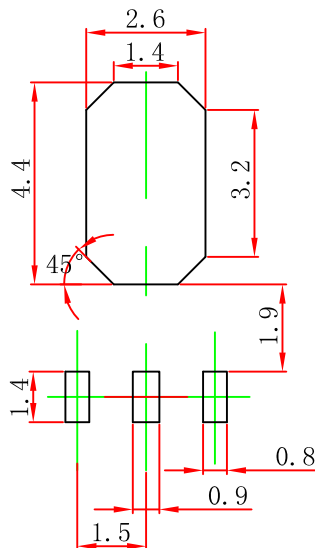

- Note:
1. Controlling dimension: in millimeters.
  2. General tolerance:  $\pm 0.05$  mm.
  3. The pad layout is for reference purposes only.

### NOTICE

JCET reserve the right to make modifications, enhancements, improvements, corrections or other changes without further notice to any product herein. JCET does not assume any liability arising out of the application or use of any product described herein.

## SOT-89-3L Tape and Reel

### SOT-89-3L Embossed Carrier Tape

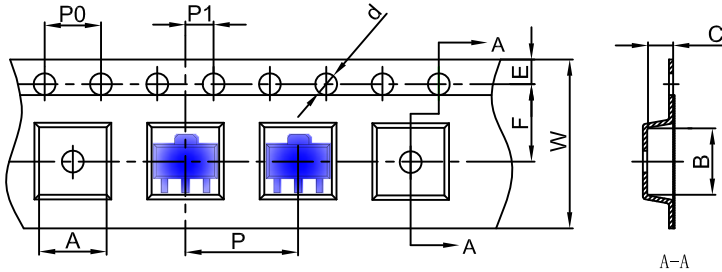

#### Packaging Description:

SOT-89-3L parts are shipped in tape. The carrier tape is made from a dissipative (carbon filled) polycarbonate resin. The cover tape is a multilayer film (Heat Activated Adhesive in nature) primarily composed of polyester film, adhesive layer, sealant, and anti-static sprayed agent. These reeled parts in standard option are shipped with 1,000 units per 7" or 18.0 cm diameter reel. The reels are clear in color and is made of polystyrene plastic (anti-static coated).

Dimensions are in millimeter

Pkg type	A	B	C	d	E	F	P0	P	P1	W
SOT-89-3L	4.85	4.45	1.85	Ø1.50	1.75	5.50	4.00	8.00	2.00	12.00

### SOT-89-3L Tape Leader and Trailer

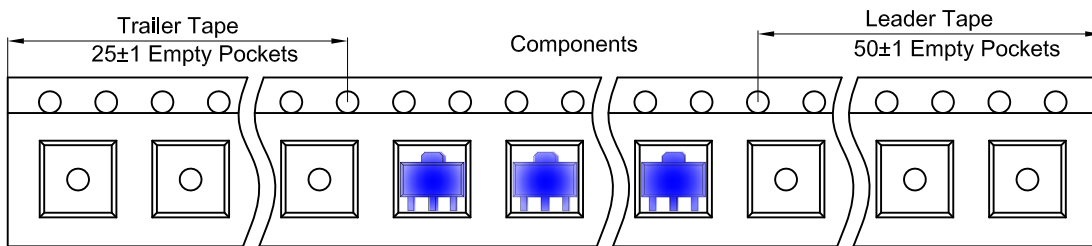

### SOT-89-3L Reel

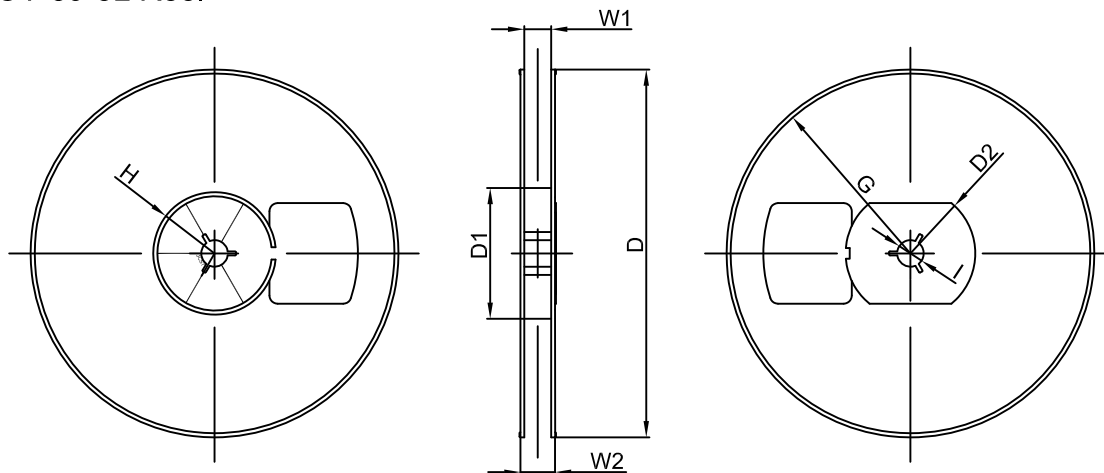

Dimensions are in millimeter

Reel Option	D	D1	D2	G	H	I	W1	W2
7" Dia	Ø180.00	60.00	R32.00	R86.50	R30.00	Ø13.00	13.20	16.50

REEL	Reel Size	Box	Box Size(mm)	Carton	Carton Size(mm)	G.W.(kg)
1000 pcs	7 inch	10,000 pcs	203×203×195	40,000 pcs	438×438×220	