



Guangdong Taixing photoelectric technology Co., LTD

规格书 Product specification

客户名称:

Customer

客户商品代码:

Customer Type

品名:

Product

产品型号: TX-TBBYBMRDL-ZS-06

RART

审核:

CHeck

制作:

Design

日期:

2024.07.10

Date

WEB : www.taixingled.com

E-MAIL : gd@taixingled.com

TEL : 0769-21683819

Characteristics 特点：

1.6mm 0.8mm SMTLED, 0.65mm thickness.
 长1.6毫米 宽0.8毫米, 厚0.65毫米.
 Luminous color and colloid: Blue/colloid transparent.
 发光颜色和胶体: 蓝色/胶体透明.
 Package: 4000pcs/reel
 包装: 4000个/卷

Features 产品特征：

Small size, small heat, high light efficiency, low light decay.
 体积小, 发热量小, 光效高, 光衰小.
 Fast reaction speed, long life, a variety of colors to choose.
 反应速度快, 寿命长, 有多种颜色可供选择.
 Suitable for SMT assembly and welding processes.
 适用于SMT组装和焊接工艺.
 Environmental protection process meets ROHS environmental requirements.
 环保工艺符合ROHS环保要求.

Package Dimension 外观尺寸：

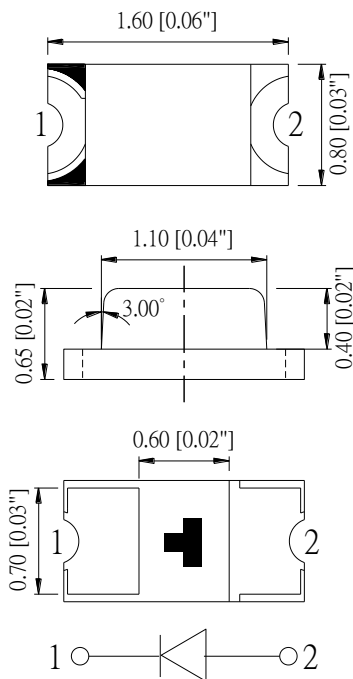

Recommend Soldering Pad 推荐焊盘

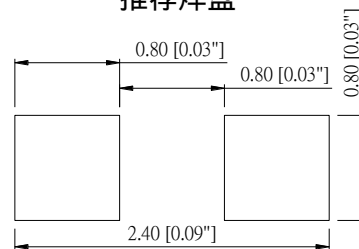

Tips: This product is only suitable for indoor, consumer category indicator light, if there are other uses, please consult our business recommendation.

温馨提示：此款产品仅适用于室内，消费品类指示灯，如有其他用途需要具体请咨询我们业务推荐。

Notes 备注：

- All dimensions are in millimeters (inches);
所有尺寸均以毫米(英寸)为单位；
- Tolerances are 0.1mm 0.004inch unless otherwise noted.
除非另有说明，公差0.1mm0.004英寸。

Absolute maximum ratings (TA=25°C) 绝对最大额定值(TA=25)

Parameter 参数	Symbol 符号	Value 数值	Unit 单位
Forward current 正向电流 www.taixingled.com	If	5	mA
Reverse voltage 反向电压	Vr	5	V
Power dissipation 功耗	Pd	15	mW
Operating temperature 工作温度	Top	-40 ~+85	°C
ESD(Human-body mode 静电)	--	2	KV
Storage temperature 储存温度	Tstg	-40 ~+85	°C
Peak pulsing current (1/8 duty f=1kHz) 峰值脉冲电流	Ifp	20	mA

Electro-optical characteristics (TA=25°C) 光电特性(TA = 25) www.taixingled.com

Parameter 参数	Test Condition 测试条件	Symbol 符号	Value 数值			Unit 单位
			Min 最小	Typ 中间	Max 最大	
Wavelength at peak emission 峰值发射波长	If=5mA	λ_p	--	465	--	nm
Spectral half bandwidth 半波宽	If=5mA	$\Delta\lambda$	--	25	--	nm
Dominant wavelength 主波长	If=5mA	λ_d	460	--	470	nm
Forward voltage 正向电压	If=5mA	Vf	2.6	--	3.2	V
Luminous intensity 光强度	If=5mA	Iv	15	--	50	mcd
Viewing angle at 50% Iv 50%视距下的视角	If=10mA	2 θ 1/2	www.taixingled.com	120	--	Deg
Reverse current 反向漏电流	Vr=5V	Ir	--	--	10	μ A

www.taixingled.com

Typical Optical Characteristics Curves 典型光学特性曲线

www.taixingled.com

Forward Current vs Forward Voltage
Ta=25°C 正向电流VS电压

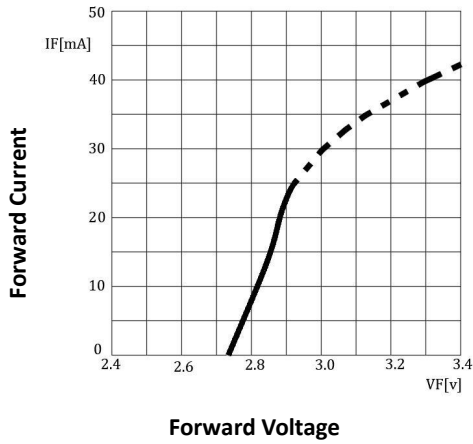

Forward Current Derating Curve
正向电流降额曲线

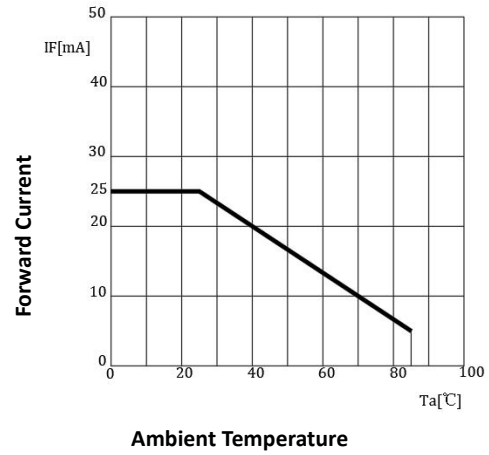

Radiation Characteristics 辐射特性
IF=10mA Ta=25°C

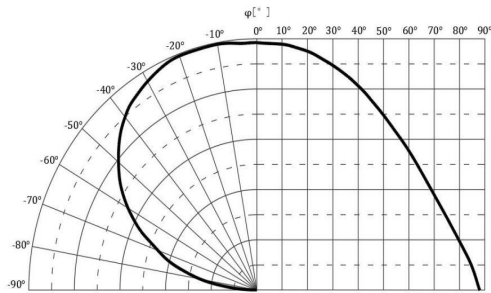

Relative Spectral Emission 相对光谱发射
IF=5 mA, Ta=25°C

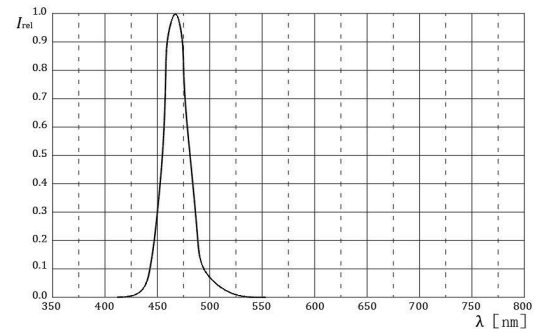

www.taixingled.com

Reflow Profile 炉温

■ Reflow Temp/Time 回流焊温度/时间 www.taixingled.com

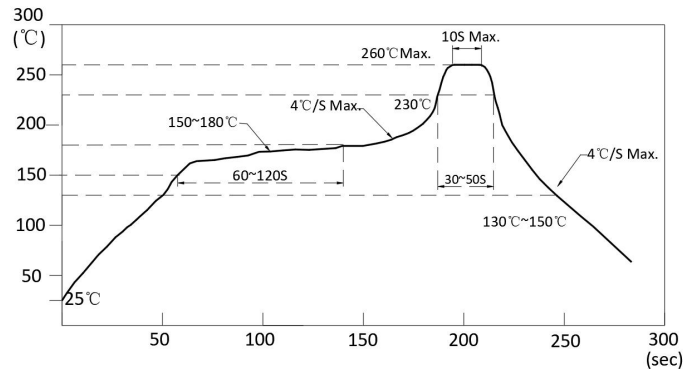

Notes: 备注：

1. We recommend the reflow temperature 245°C (±5°C).The maximum soldering temperature should be limited to 260°C www.taixingled.com
我们推荐回流温度为245 (±5)。最高焊接温度应限制在260。
2. Don't cause stress to the epoxy resin while it is exposed to high temperature.
环氧树脂暴露在高温下时不要对其造成应力。
3. Number of reflow process shall be 2 times or less.
回流焊次数不超过2次。

■Soldering iron 烙铁使用

Basic spec is ≤5sec when 320°C (±20°C). If temperature is higher, time should be shorter (+10°C → -1sec). Power dissipation of iron should be smaller than 20W, and temperatures should be controllable .Surface temperature of the device should be under 350°C

基本规格为320 (±20)时5秒。温度越高，时间越短(+10 -1秒)。烙铁的功耗应小于20W，温度应可控设备温度应在350 以下。

■Rework 返工

1. Customer must finish rework within 5 sec under 340°C. 客户必须在340 下5秒内完成返工。
2. The head of iron cannot touch copper foil 。铁头不能碰到铜箔。
3. Twin-head type is preferred. . 首选双头型。 www.taixingled.com

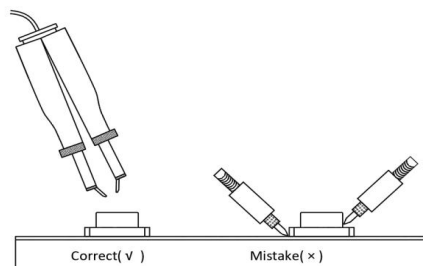

- Avoid rubbing or scraping the resin by any object, during high temperature, for example reflow solder etc.
避免任何物体摩擦或刮擦树脂，在高温下，如回流焊等。

Handling precautions 使用处理措施 www.taixingled.com

1. Drive Method. 驱动方法

A LED is a current-operated device. In order to ensure intensity uniformity on multiple LEDs connected in parallel in an application, it is recommended that a current limiting resistor be incorporated in the drive circuit, in series with each LED as shown in Circuit below. LED是电流操作的器件。为了确保应用中并联的多个LED的强度均匀性，建议在驱动电路中加入一个限流电阻，与每个LED串联，如下图所示：

www.taixingled.com

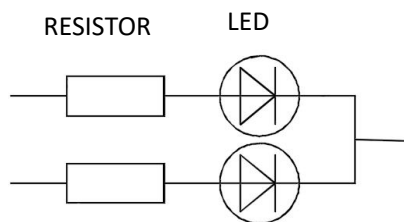

2. Storage 储存

2.1 Do not open moisture proof bag before the products are ready to use.

在产品准备使用之前，请勿打开防潮袋。

2.2 Before opening the package: The LEDs should be kept at 30°C or less and 60% RH or less.

打开包装前：LED应保持在30°C以下，60%RH以下。

2.3 After the package is opened, the products should be used within a week or they should be keeping to store at ≤ 20 R.H. with zip-lock sealed.

打开包装后，产品应在一周内用完或以 ≤ 20 R.H. 的温度保存，并以拉链密封。

3. Baking 烘烤处理

It is recommended to baking before soldering when the pack is unsealed after 72hrs. The Conditions are as followings: 当包装在72小时后打开密封时，建议在焊接前进行烘烤。条件如下：

3.1 60 \pm 3°C x (12~24hrs) and <5%RH, taped reel type

3.2 100 \pm 3°C x (45min~1hr), bulk type

3.3 130 \pm 3°C x (15~30min), bulk type

Test items and results of reliability 可靠性测试专案及结果

Test Item 测试项目	Test Conditions 测试条件	Standard Test Method 标准试验方法	Note 注意	Number of Test 测试次数
Reflow Soldering 静态回流焊	Ta=260±5℃,Time=10±2S	JB/T 10845-2008	3times	0/22
Temperature Cycling 静态温度迴圈	-40±5℃ 30±1min ↑→(25℃/5±1min)↓ 100±5℃ 30±1min	GB/T 2423.22-2012	100cycles	0/22
High Humidity High Temp. Storage Life 静态高温高湿	Ta=85±5℃,ψ(%)=85±5%RH	GB/T 2423.3-2006	1000hrs	0/22
High Temperature Storage Life 静态高温储存	Ta=100±5℃,non-operating	GB/T 2423.2-2008	1000hrs	0/22
Low Temperature Storage Life 静态低温储存	Ta=-40±5℃,non-operating	GB/T 2423.1-2008	1000hrs	0/22
Life Test 动态室温通电	Ta=26±5℃,@5 mA, ψ(%)=25%RH~55%RH	--	1000hrs	0/22
Low Temperature Operating Life 动态低温通电	a=-20±5℃,@5 mA	GB/T 2423.1-2008	1000hrs	0/22

Notes 备注：

1. The tolerance of luminous intensity (Iv) is ±15% . 发光强度(Iv)公差为±15%。
2. The tolerance of dominant wavelength is ±2nm. 主导波长公差为±2nm。
3. The tolerance of Voltage is ±0.1V. 电压公差为±0.1V www.taixingled.com
4. This specification is a standard specification of our factory, can make in accordance with customer's special requirement. 本规格为我厂标准规格，可根据客户的特殊要求定做。

Series SMD Chip LED Lamps Packaging Specifications 系列贴片led灯封装规范

● Feeding Direction 编带方向

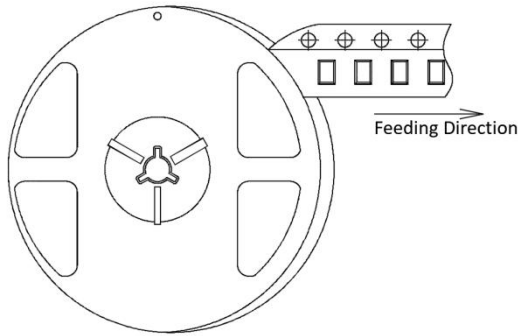

● Dimensions of Reel (Unit: mm) 卷盘尺寸

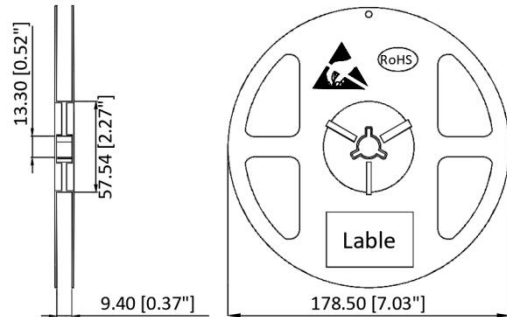

● Dimensions of Tape (Unit: mm) 胶带尺寸 (单位:mm)

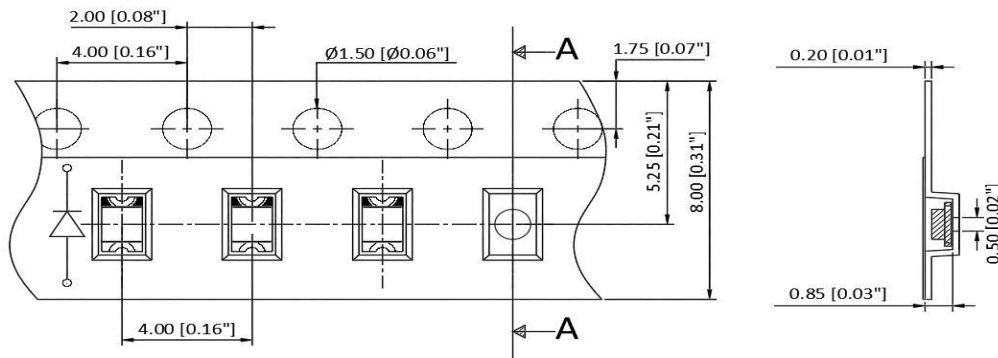

● Arrangement of Tape 编带方式

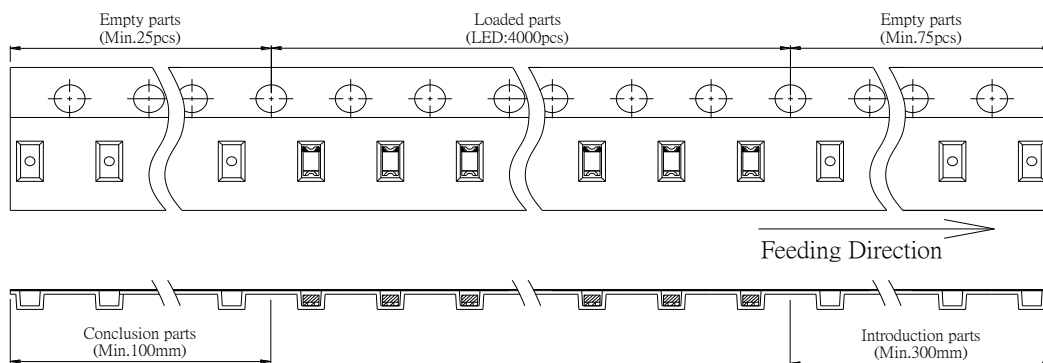

Notes 备注 :

1. Empty component pockets are sealed with top cover tape;B 用顶盖胶带密封空部件口袋;
2. The maximum number of missing lamps is two; 最多漏灯为2个
3. 4,000pcs/Reel. 4000个每盘

Series Chip LED Lamps Packaging Specifications 系列贴片led灯封装规范

● **Transportation Packing 运输包装**

www.taixingled.com

