

**LSIC2SD065A20A 650 V, 20 A SiC Schottky Barrier Diode**

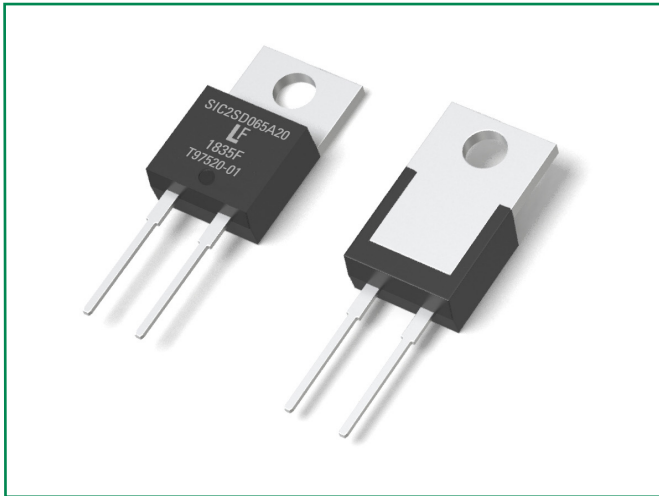

**Description**

This series of silicon carbide (SiC) Schottky diodes has negligible reverse recovery current, high surge capability, and a maximum operating junction temperature of 175 °C. These diodes series are ideal for applications where improvements in efficiency, reliability, and thermal management are desired.

**Features**

- AEC-Q101 qualified
- Positive temperature coefficient for safe operation and ease of paralleling
- 175 °C maximum operating junction temperature
- Excellent surge capability
- Extremely fast, temperature-independent switching behavior
- Dramatically reduced switching losses compared to Si bipolar diodes

**Circuit Diagram TO-220-2L**

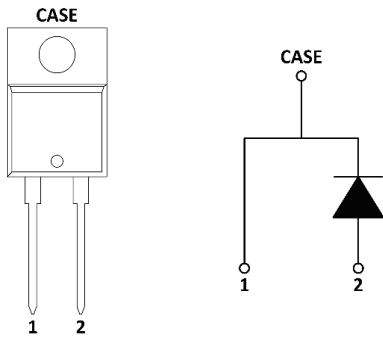

**Applications**

- Boost diodes in PFC or DC/DC stages
- Switch-mode power supplies
- Uninterruptible power supplies
- Solar inverters
- Industrial motor drives
- EV charging stations

**Environmental**

- Littelfuse "RoHS" logo = RoHS conform
- Littelfuse "HF" logo = **HF** Halogen Free
- Littelfuse "Pb-free" logo = Pb-free lead plating

**Maximum Ratings**

Characteristics	Symbol	Conditions	Value	Unit
Repetitive Peak Reverse Voltage	$V_{RRM}$	-	650	V
DC Blocking Voltage	$V_R$	$T_J = 25\text{ °C}$	650	V
Continuous Forward Current	$I_F$	$T_C = 25\text{ °C}$	45	A
		$T_C = 135\text{ °C}$	20	
Non-Repetitive Forward Surge Current	$I_{FSM}$	$T_C = 25\text{ °C}, T_P = 10\text{ ms}, \text{Half sine pulse}$	90	A
Power Dissipation	$P_{Tot}$	$T_C = 25\text{ °C}$	135	W
		$T_C = 110\text{ °C}$	60	
Operating Junction Temperature	$T_J$	-	-55 to 175	°C
Storage Temperature	$T_{STG}$	-	-55 to 150	°C
Soldering Temperature	$T_{SOLD}$	-	260	°C

**Electrical Characteristics ( $T_J = 25^\circ\text{C}$  unless otherwise specified)**

Characteristics	Symbol	Conditions	Value			Unit
			Min.	Typ.	Max.	
Forward Voltage	$V_F$	$I_F = 20\text{ A}, T_J = 25^\circ\text{C}$	-	1.5	1.8	V
		$I_F = 20\text{ A}, T_J = 175^\circ\text{C}$	-	1.85	-	
Reverse Current	$I_R$	$V_R = 650\text{ V}, T_J = 25^\circ\text{C}$	-	<1	50	$\mu\text{A}$
		$V_R = 650\text{ V}, T_J = 175^\circ\text{C}$	-	60	-	
Total Capacitance	C	$V_R = 1\text{ V}, f = 1\text{ MHz}$	-	960	-	pF
		$V_R = 200\text{ V}, f = 1\text{ MHz}$	-	120	-	
		$V_R = 400\text{ V}, f = 1\text{ MHz}$	-	86	-	
Total Capacitive Charge	$Q_C$	$V_R = 400\text{ V}, Q_C = \int_0^{V_R} C(V)dV$	-	63	-	nC

**Thermal Characteristics**

Characteristics	Symbol	Value	Unit
Thermal Resistance	$R_{\theta JC}$	1.1	$^\circ\text{C}/\text{W}$

**Figure 1: Typical Forward Characteristics**

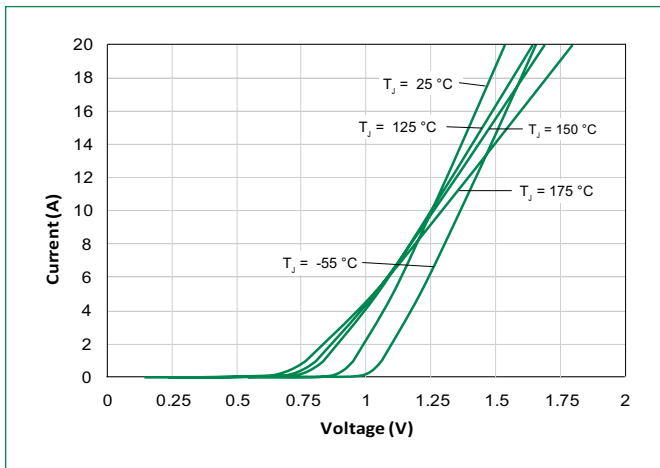

**Figure 2: Typical Reverse Characteristics**

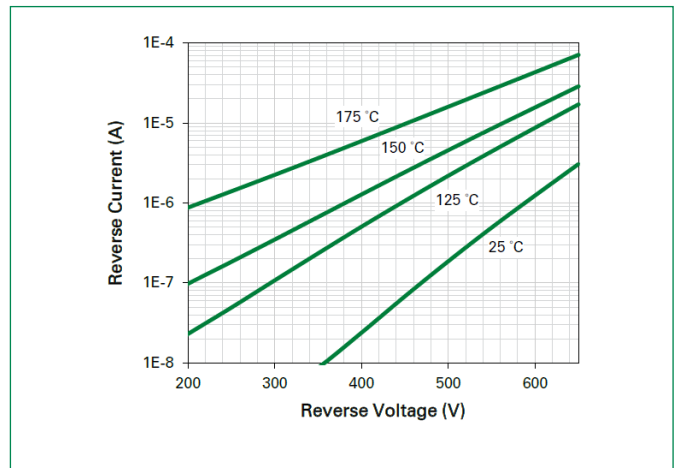

**Figure 3: Power Derating**

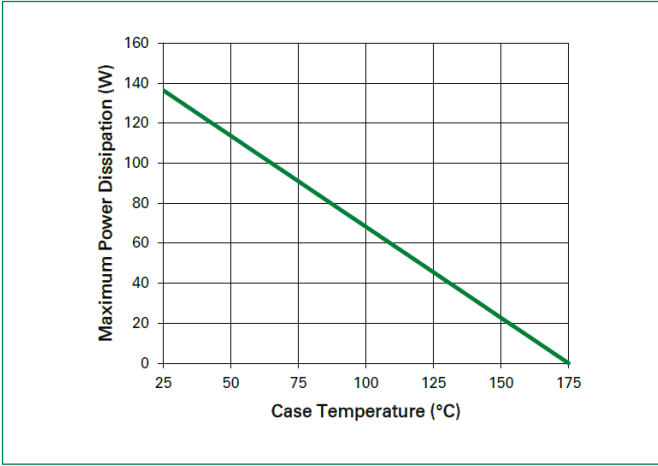

**Figure 4: Current Derating**

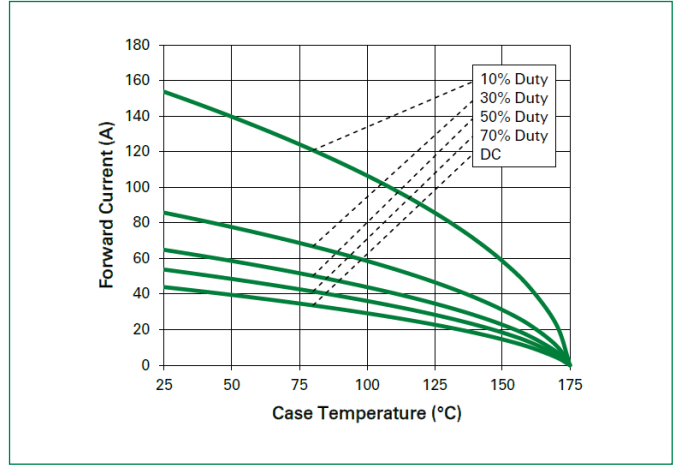

**Figure 5: Capacitance vs. Reverse Voltage**

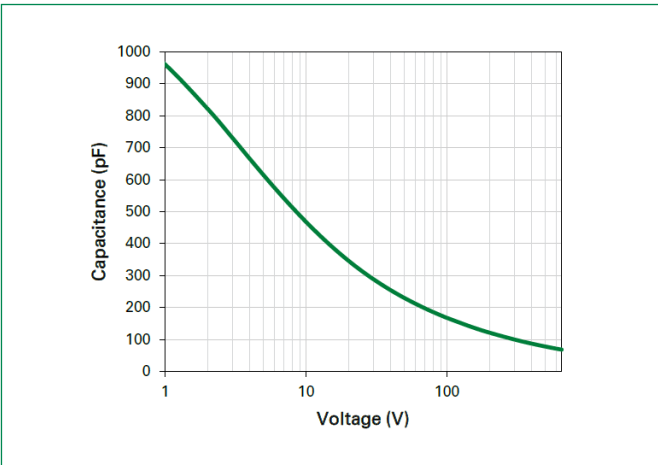

**Figure 6: Capacitive Charge vs. Reverse Voltage**

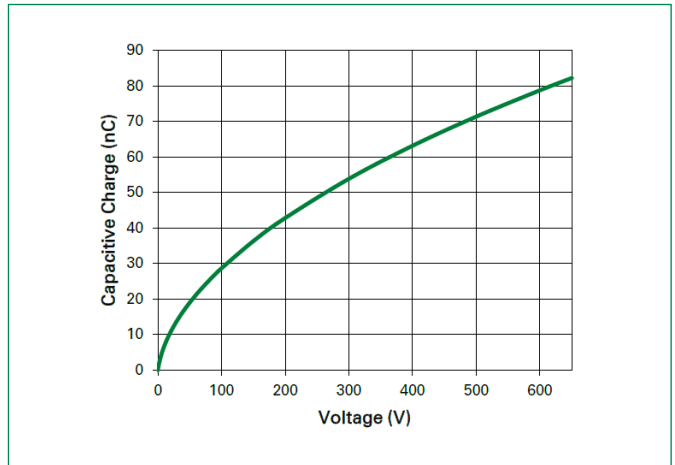

**Figure 7: Stored Energy vs. Reverse Voltage**

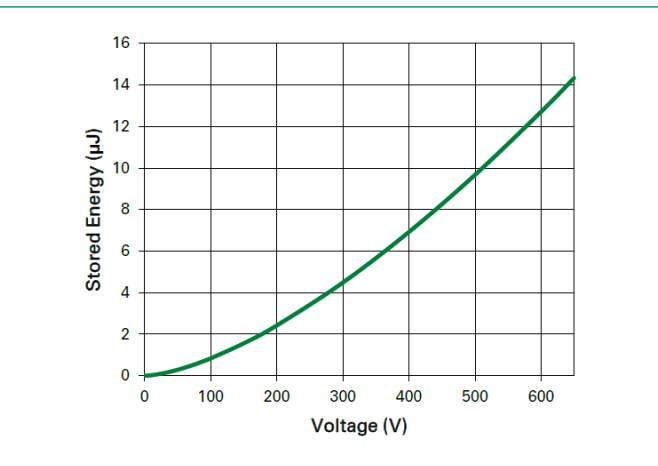

**Figure 8: Transient Thermal Impedance**

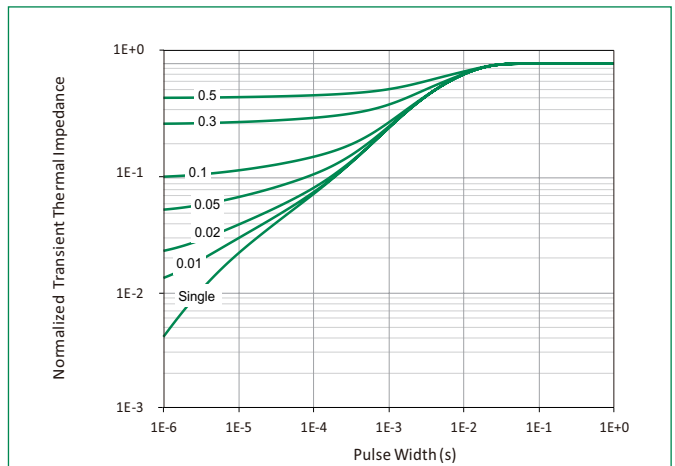

**Dimensions-Package TO-220-2L**

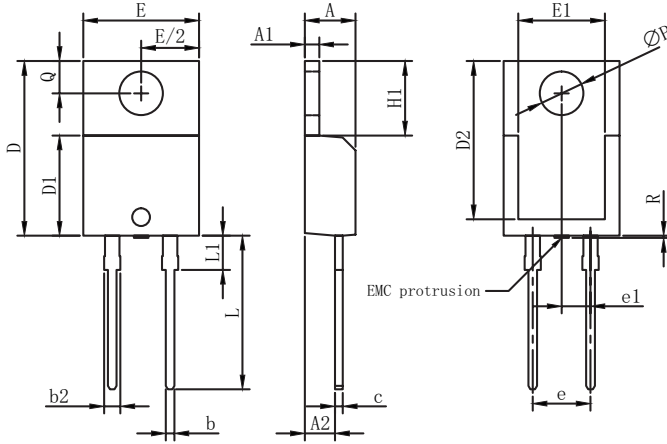

Recommended Solder Pad Layout

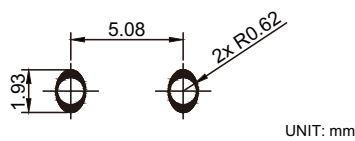

Symbol	Millimeters		
	Min	Nom	Max
A	4.32	4.45	4.70
A1	1.14	1.27	1.40
A2	2.20	-	2.74
b	0.69	-	0.90
b2	1.17	-	1.62
c	0.36	-	0.60
D	14.90	-	15.90
D1	8.62	-	9.40
D2	12.50	-	12.95
E	9.70	10.18	10.36
E1	7.57	7.61	8.30
e1	-	2.54	-
e	5.03	5.08	5.13
H1	6.30	6.55	6.80
L	12.88	13.50	14.00
L1	2.39	-	3.25
øP	3.50	3.84	3.96
Q	2.65	-	3.05
R	-	-	0.25

**Part Numbering and Marking System**

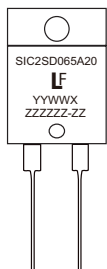

- SIC = SiC Diode
- 2 = Gen2
- SD = Schottky Diode
- 065 = Voltage Rating (650 V)
- A = TO-220 Package (2 Lead)
- 20 = Current Rating (20 A)
- YY = Year
- WW = Week
- X = Special Code
- ZZZZZ-ZZ = Lot Number

**Packing Options**

Part Number	Marking	Packing Mode	M.O.Q
LSIC2SD065A20A	SIC2SD065A20	Tube(50pcs)	1000

### Packing Specification (Tube for TO-220-2L)

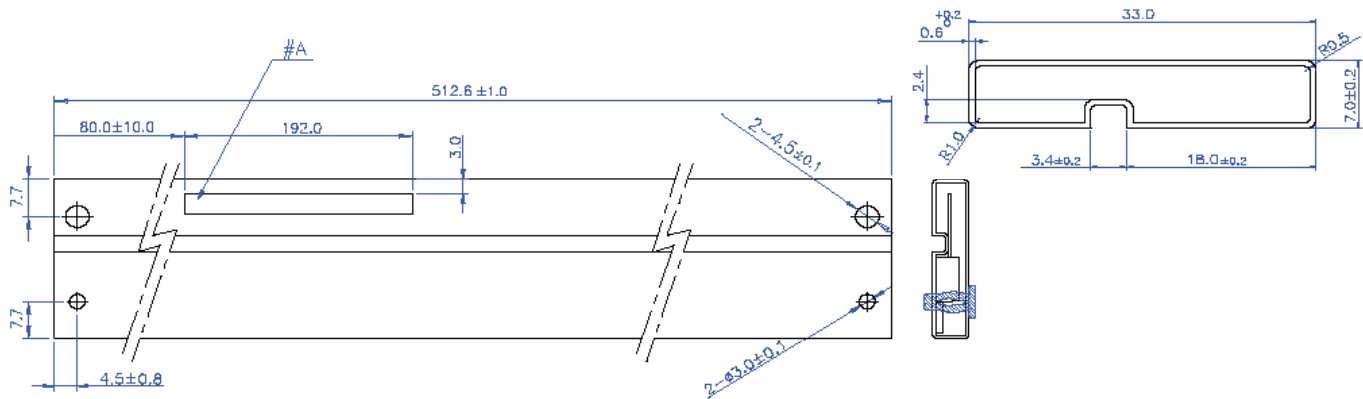

#### [ NOTE ]

1. TUBE
  - MATERIAL : PVC / PET (WITH ANTISTATIC COATING)
  - COLOR : TRANSPARENCY, RED, YELLO
  - MARKING #A : BLACK COLOR, LETTER STYLE : Arial
  - Tube Surface Resistance :  $10^8 \sim 10^{11} \Omega$ /square
  - ESD (Electro Static Discharge) : less than 100 [volts], 6 Months
  - CAMBAR : 1.5 MAX
2. PIN
  - COLOR : GREEN (ONE PIN MUST BE INSERTED IN LEFT-SIDE OF "□ANTISTATIC-" AND ANOTHER PIN IS FREE.)

**Disclaimer Notice -** Littelfuse products are not designed for, and shall not be used for, any purpose (including, without limitation, automotive, military, aerospace, medical, life-saving, life-sustaining or nuclear facility applications, Components intended for surgical implant into the body, or any other application in which the failure or lack of desired operation of the product may result in personal injury, death, or property damage) other than those expressly set forth in applicable Littelfuse product documentation. Warranties granted by Littelfuse shall be deemed void for products used for any purpose not expressly set forth in applicable Littelfuse documentation. Littelfuse shall not be liable for any claims or damages arising out of products used in applications not expressly intended by Littelfuse as set forth in applicable Littelfuse documentation. The sale and use of Littelfuse products is subject to Littelfuse Terms and Conditions of Sale, unless otherwise agreed by Littelfuse. Information furnished is believed to be accurate and reliable. However, users should independently evaluate the suitability of and test each product selected for their own applications. Littelfuse products are not designed for, and may not be used in, all applications. Read complete Disclaimer Notice at [www.littelfuse.com/disclaimer-electronics](http://www.littelfuse.com/disclaimer-electronics).