

Material
 Housing Material: LCP, UL94V-0, black
 Contact Terminal: Copper Alloy
 Metallic Shell: Brass
 Electrical
 Voltage Rating: 30 V AC
 Current Rating: Signal (Pins 2,3,4): 1.0A, Power (Pins 1,5): 1.8A
 Contact Resistance: 30mΩ Max
 Insulation resistance: 1000MΩ Min
 Dielectric withstanding voltage: 250V AC/Minute
 Mechanical
 Durability: 3,000 cycles
 Mating Force: 35N (3.57Kgf) Max
 Unmating Force: 8N (0.82Kgf) Min.

U254-05XX-4BHJ233-XB
 1:AU 1U"
 6:AU 30U"
 T:TIN
 N:NICKEL
 B:Brass
 S:Scrolls F:Flat

广东星坤科技股份有限公司

P.C.B.Land Pattern

生	日期
发	日期
ΔX	
MARK	
文件工程章	

REVISIONS	DATE	REVISED	APPROVED	UNSPECIFIED TOLERANCES
ANGULAR				±5°
L ≤ 4				±0.2
4 < L ≤ 16				±0.3
16 < L ≤ 63				±0.4
L > 63				±0.5

DSND	DATE	SCALE: N/A	MODEL TYPE:
DWN	DATE	VIEW:	MICRO USB
CHKD	DATE	UNIT: mm/in	PART NO.:
APPD	DATE	SIZE: A4	DWG NO.:
			U254-05XX-4BHJ233-SB
		WEIGHT	SHEET
		1.0g	1/1
		REVISION	
		A0	

KXB INDUSTRIAL PRECISION CO., LIMITED

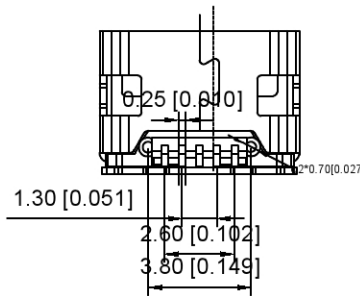
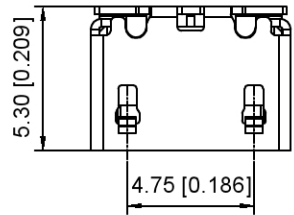
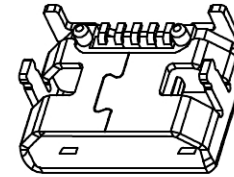
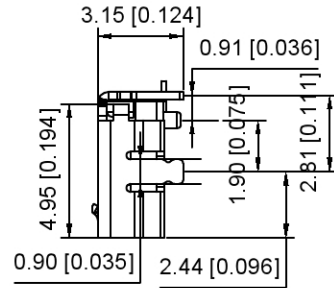
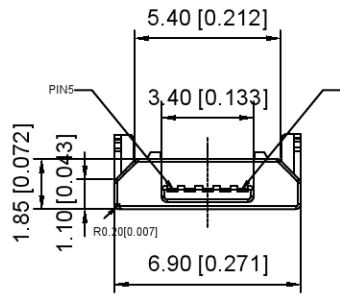

Material

Housing Material: LCP, UL94V-0, black

Contact Terminal: Copper Alloy

Metallic Shell: Brass

Electrical

Voltage Rating: 30 V AC

Current Rating: Signal (Pins 2,3,4): 1.0A, Power (Pins 1,5): 1.8A

Contact Resistance: 30mΩ Max

Insulation resistance: 1000MΩ Min

Dielectric withstanding voltage: 250V AC/Minute

Mechanical

Durability: 3,000 cycles

Mating Force: 35N (3.57Kgf) Max

Unmating Force: 8N (0.82Kgf) Min.

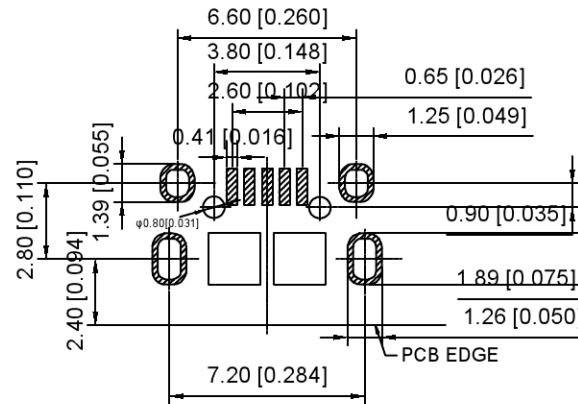
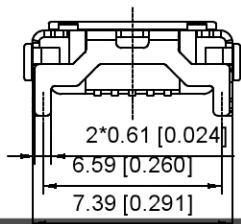

P.C.B. Land Pattern

U254-05XX-4BHJ233-XB

1:AU 1U"

6:AU 30U"

T:TIN

N:NICKEL

B:Brass

S:Scrolls F:Flat

广东星坤科技股份有限公司

生	日期
发	日期

文件工程章	REVISIONS
DATE	REVISED
APPROVED	UNSPECIFIED TOLERANCES

www.xkcg.cn www.helloxkb.com www.helloxkb.cn

DSND	DATE	SCALE: N/A	MODEL TYPE:
DWN	DATE	VIEW:	MICRO USB
CHKD	DATE	UNIT: mm/in	PART NO.:
APPD	DATE	SIZE: A4	DWG NO.:
KXB INDUSTRIAL PRECISION CO., LIMITED			U254-05XX-4BHJ233-FB
WEIGHT	SHEET	REVISION	
1.0g	1/1	A0	