

SS32C~SS320C

Rev. B Feb.-2021

描述 / Descriptions

表面贴装肖特基整流二极管，反向电压：20~200V，正向电流：3.0A，SMC 封装。

Surface Mount Schottky Barrier Rectifier, Reverse Voltage: 20 to 200 V, Forward Current:3.0A ,SMC package.

特征 / Features

低功耗，高效率，正向浪涌电流大，适用于低压高频逆变器和极性保护，适用于表面贴装，无卤产品。

Low power loss, high efficiency, High forward surge current capability, For use in low voltage, high frequency inverters, and polarity protection applications,For surface mounted applications.Halogen free product.

用途 / Applications

一般用途.

General purpose.

内部等效电路 / Equivalent Circuit



引脚排列 / Pinning

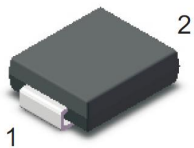

PIN	DESCRIPTION
1	Cathode
2	Anode

The recommended mounting pad size

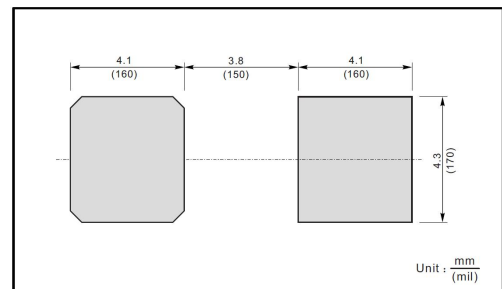

印章代码 / Marking

见印章说明。 See Marking Instructions.

极限参数 / Absolute Maximum Ratings(Ta=25°C)

参数 Parameter	符号 Symbol	数值 Rating								单位 Unit
		SS32C	SS34C	SS36C	SS38C	SS310C	SS312C	SS315C	SS320C	
Maximum Repetitive Peak Reverse Voltage	V_{RRM}	20	40	60	80	100	120	150	200	V
Maximum RMS voltage	V_{RMS}	14	28	42	56	70	84	105	140	V
Maximum DC Blocking Voltage	V_{DC}	20	40	60	80	100	120	150	200	V
Maximum Average Forward Rectified Current	$I_{F(AV)}$	3.0								A
Peak Forward Surge Current,8.3ms Single Half Sine-wave Superimposed on Rated Load (JEDEC method)	I_{FSM}	80								A
Typical Junction Capacitance ¹⁾	C_i	450			350					pF
Typical Thermal Resistance ²⁾	$R_{\theta JA}$	50								°C/W
Operating Junction Temperature Range	T_j	-55~+150								°C
Storage Temperature Range	T_{stg}	-55~+150								°C

Note:

- 1) Measured at 1MHz and applied reverse voltage of 4 V D.C.
- 2) P.C.B. mounted with 2.0 X 2.0" (5 X 5 cm) copper pad areas.

电性能参数 / Electrical Characteristics(Ta=25°C)

参数 Parameter	符号 Symbol	测试条件 Test Conditions	数值 Rating							单位 Unit
			SS32C	SS34C	SS36C	SS38C	SS310C	SS312C	SS315C	
Max Instantaneous Forward Voltage	V_F	$I_F=3.0A$	0.55		0.70	0.85		0.95		V
Maximum DC Reverse Current at Rated DC Reverse Voltage	I_R	$T_a=25^\circ C$	0.5			0.3				mA
		$T_a=100^\circ C$	5.0			3.0				

电参数曲线图 / Electrical Characteristic Curve

Fig.1 Forward Current Derating Curve

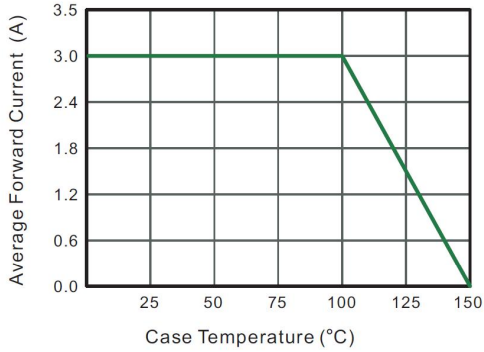

Fig.2 Typical Reverse Characteristics

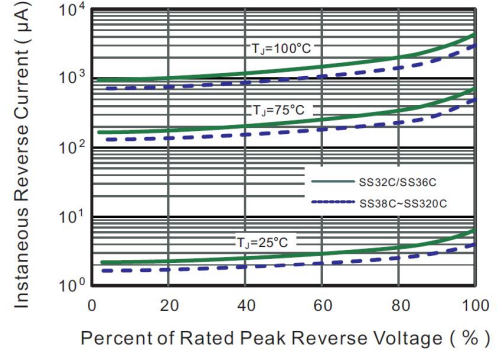

Fig.3 Typical Forward Characteristic

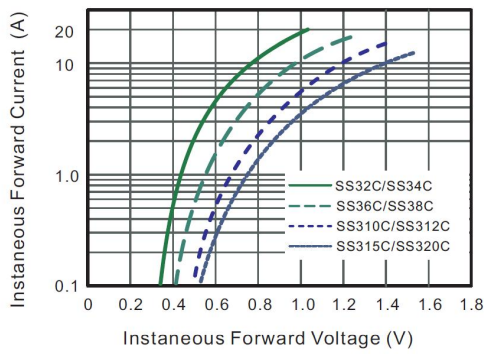

Fig.4 Typical Junction Capacitance

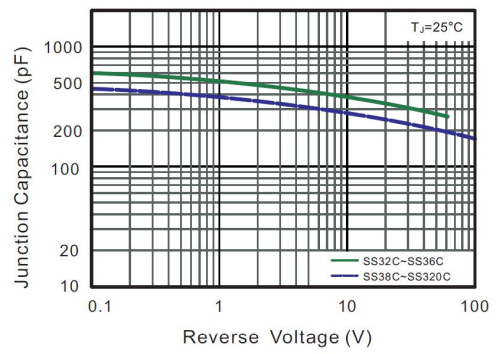

Fig.5 Maximum Non-Repetitive Peak Forward Surge Current

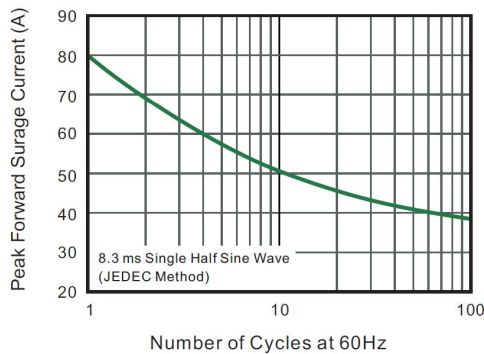
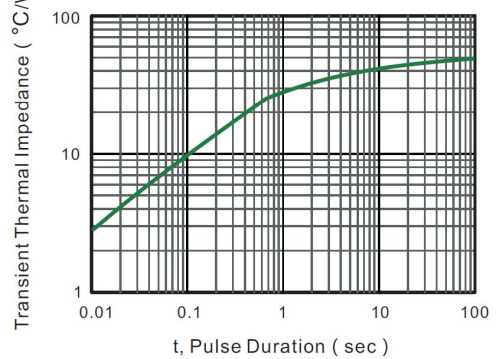
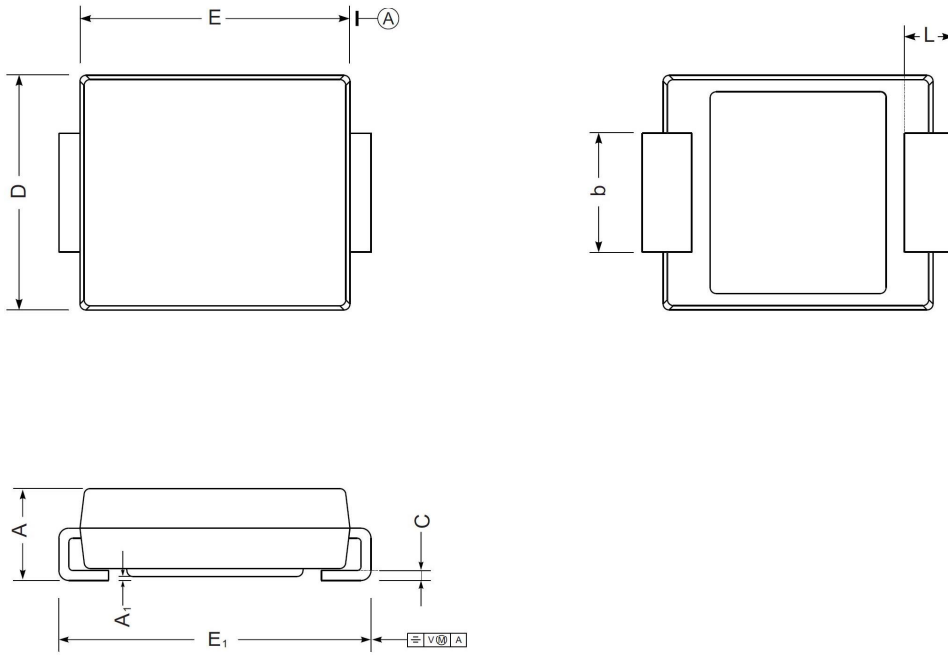

Fig.6- Typical Transient Thermal Impedance



外形尺寸图 / Package Dimensions

SMC



SMC mechanical data

UNIT		A	E	D	E ₁	A ₁	C	L	b
mm	max	2.62	7.0	6.2	8.0	0.21	0.31	1.6	3.25
	min	2.00	6.5	5.6	7.6	0.05	0.15	0.9	2.75
mil	max	103	276	244	315	8.3	12	63	128
	min	79	256	220	299	2.0	5.9	35	108



Marking

Type number	Marking code
SS32C	SS32
SS34C	SS34
SS36C	SS36
SS38C	SS38
SS310C	SS310
SS312C	SS312
SS315C	SS315
SS320C	SS320

印章说明 / Marking Instructions



说明

SS32 : 为型号代码

**** : 为生产批号追溯码, 第 1 个*为年月代码, 后面 3 个*为当月小批号代码

Note:

SS32 : Product Type Code

**** : Lot No. Code ,The 1st * means:YM Code ,The last 3 * means:little Lot No Code

回流焊温度曲线图(无铅) / Temperature Profile for IR Reflow Soldering(Pb-Free)

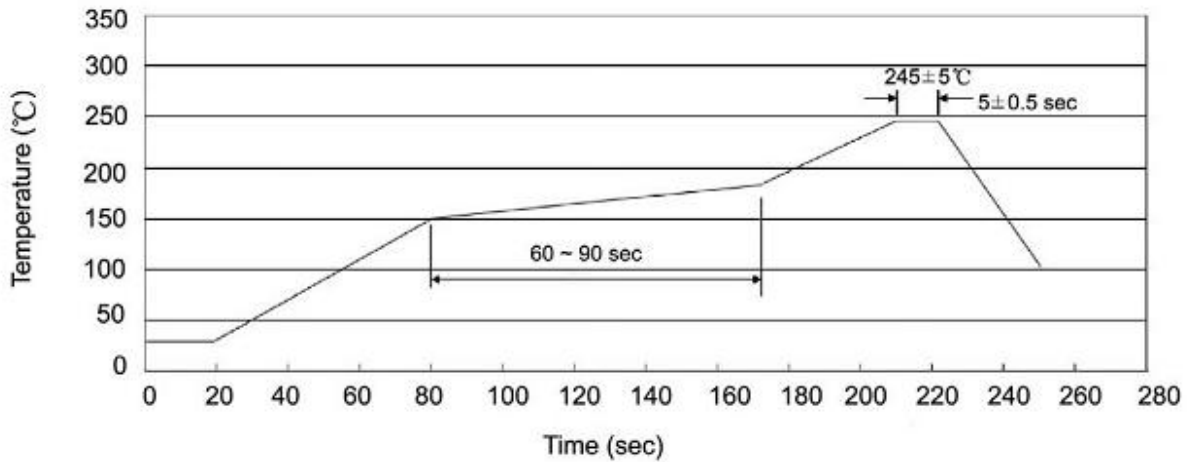

说明：

- 1、预热温度 150 ~ 180°C，时间 60 ~ 90sec；
- 2、峰值温度 245±5°C，时间持续为 5±0.5sec；
- 3、焊接制程冷却速度为 2 ~ 10°C/sec.

Note:

- 1.Preheating:150~180°C, Time:60~90sec.
- 2.Peak Temp.:245±5°C, Duration:5±0.5sec.
3. Cooling Speed: 2~10°C/sec.

耐焊接热试验条件 / Resistance to Soldering Heat Test Conditions

温度：260±5°C

时间：10±1 sec.

Temp.:260±5°C

Time:10±1 sec

包装规格 / Packaging SPEC.

卷盘包装 / REEL

Package Type 封装形式	Units 包装数量					Dimension 包装尺寸 (unit: mm ³)		
	Units/Reel 只/卷盘	Reels/Inner Box 卷盘/盒	Units/Inner Box 只/盒	Inner Boxes/Outer Box 盒/箱	Units/Outer Box 只/箱	Reel	Inner Box 盒	Outer Box 箱
SMC	3000	2	6000	6	36000	13" ×16	337X337X49	380X335X366

使用说明 / Notices