

# Z8691 Z8<sup>®</sup>

## ROMLESS MICROCONTROLLER

### FEATURES

- Complete microcomputer, 24 I/O lines, and up to 64K bytes of addressable external space each for program and data memory.
- 143-byte register file, including 124 general-purpose registers, 3 I/O port registers, and 16 status and control registers.
- Vectored, priority interrupts for I/O, counter/timers, and UART.
- On-chip oscillator that accepts crystal or external clock drive.
- Full-duplex UART and two programmable 8-bit counter/timers, each with a 6-bit programmable prescaler.
- Register Pointer so that short, fast instructions can access any one of the nine working-register groups.
- Single +5V power supply—all I/O pins TTL compatible.
- 8 MHz/12 MHz versions.

### GENERAL DESCRIPTION

The Z8691 is a ROMless version of the Z8 single-chip microcomputer. The Z8691 offers all the outstanding features of the Z8 family architecture except an on-chip program ROM. Use of external memory rather than a

preprogrammed ROM enables this Z8 microcomputer to be used in low volume applications or where code flexibility is required.

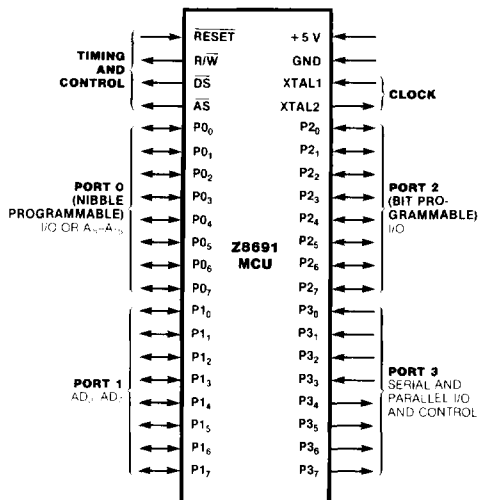

Figure 1. Pin Functions

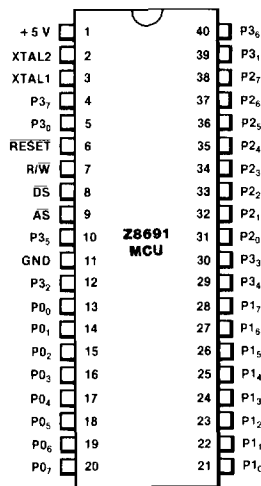

Figure 2a. 40-pin Dual-In-Line Package (DIP), Pin Assignments

The Z8691 can provide up to 16 output address lines, thus permitting an address space of up to 64K bytes of data or program memory. Eight address outputs (AD<sub>0</sub>-AD<sub>7</sub>) are provided by a multiplexed, 8-bit, Address/Data bus. The remaining 8 bits can be provided by the software configuration of Port 0 to output address bits A<sub>8</sub>-A<sub>15</sub>.

Available address space can be doubled (up to 128K bytes) by programming bit 4 of Port 3 (P<sub>3,4</sub>) to act as a data memory select output ( $\overline{DM}$ ). The two states of  $\overline{DM}$  together with the 16 address outputs can define separate data and memory address spaces of up to 64K bytes each.

There are 143 bytes of RAM located on-chip and organized as a register file of 124 general-purpose registers, 16 control and status registers, and three I/O port registers. This register file can be divided into nine groups of 16 working registers each. Configuring the register file in this manner allows the use of short format instructions; in addition, any of the individual registers can be accessed directly.

The pin functions and the pin assignments of the Z8691 40-pin and 44-pin packages are illustrated in Figures 1 and 2, respectively.

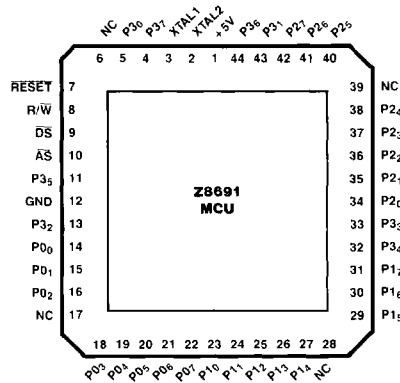

Figure 2b. 44-pin Chip Carrier, Pin Assignments

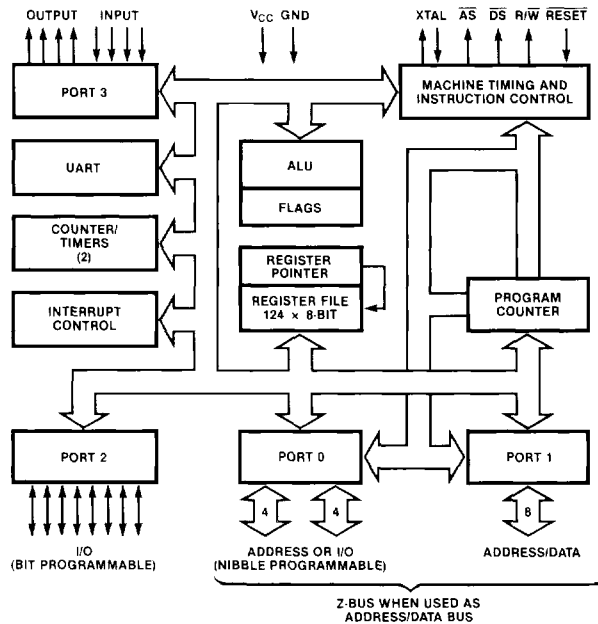

Figure 3. Functional Block Diagram

---

## ARCHITECTURE

Z8691 architecture is characterized by a flexible I/O scheme, an efficient register and address space structure and a number of ancillary features that are helpful in many applications.

Microcomputer applications demand powerful I/O capabilities. The Z8691 fulfills this with 24 pins available for input and output. These lines are grouped into three ports of eight lines each and are configurable under software control to provide timing, status signals, serial or parallel I/O with or without handshake, and an Address bus for interfacing external memory.

Three basic address spaces are available: program memory,

data memory and the register file (internal). The 143-byte random-access register file is composed of 124 general-purpose registers, three I/O port registers, and 16 control and status registers.

To unburden the program from coping with real-time problems such as serial data communication and counting/timing, an asynchronous receiver/transmitter (UART) and two counter/timers with a large number of user-selectable modes are offered on-chip. Hardware support for the UART is minimized because one of the on-chip timers supplies the bit rate. Figure 3 shows the Z8691 block diagram.

---

## PIN DESCRIPTION

**$\overline{AS}$ .** *Address Strobe* (output, active Low). Address Strobe is pulsed once at the beginning of each machine cycle. Addresses output via Port 1 for all external program or data memory transfers are valid at the trailing edge of  $\overline{AS}$ .

**$\overline{DS}$ .** *Data Strobe* (output, active Low). Data Strobe is activated once for each external memory transfer.

**$P0_0$ - $P0_7$ ,  $P2_0$ - $P2_7$ ,  $P3_0$ - $P3_7$ .** *I/O Port Lines* (input/outputs, TTL-compatible). These 24 lines are divided into three 8-bit I/O ports that can be configured under program control for I/O or external memory interface (Figure 3).

**$P1_0$ - $P1_7$ .** *Address/Data Port* (bidirectional). Multiplexed

address ( $A_0$ - $A_7$ ) and data ( $D_0$ - $D_7$ ) lines used to interface with program and data memory.

**$\overline{RESET}$ .** *Reset* (input, active Low).  $\overline{RESET}$  initializes the Z8691. After  $\overline{RESET}$  the Z8691 is in the extended memory mode. When  $\overline{RESET}$  is deactivated, program execution begins from program location 000C<sub>H</sub>.

**$R/\overline{W}$ .** *Read/Write* (output).  $R/\overline{W}$  is Low when the Z8691 is writing to external program or data memory.

**$XTAL1$ ,  $XTAL2$ .** *Crystal 1, Crystal 2* (time-base input and output). These pins connect a parallel-resonant crystal to the on-chip clock oscillator and buffer.

## ADDRESS SPACES

**Program Memory.** The Z8691 addresses 64K/62K bytes of external program memory space (Figure 4).

The first 12 bytes of program memory are reserved for the interrupt vectors. These locations contain six 16-bit vectors that correspond to the six available interrupts. Program execution begins at location 000C<sub>H</sub> after a reset.

**Data Memory.** The Z8691 can address 64K bytes of external data memory. External data memory may be included with or separated from the external program memory space.  $\overline{DM}$ , an optional I/O function that can be programmed to appear on pin P3<sub>4</sub>, is used to distinguish between data and program memory space.

**Register File.** The 143-byte register file includes three I/O port registers (R0, R2, R3), 124 general-purpose registers (R4-R127) and 16 control and status registers (R240-R255). These registers are assigned the address locations shown in Figure 5.

Z8691 instructions can access registers directly or indirectly with an 8-bit address field. This also allows short 4-bit register addressing using the Register Pointer (one of the control registers). In the 4-bit mode, the register file is divided into nine working-register groups, each occupying 16 contiguous locations (Figure 5). The Register Pointer addresses the starting location of the active working-register group (Figure 6).

**Stacks.** Either the internal register file or the external data memory can be used for the stack. A 16-bit Stack Pointer (R254 and R255) is used for the external stack, which can reside anywhere in data memory. An 8-bit Stack Pointer (R255) is used for the internal stack that resides within the 124 general-purpose registers (R4-R127).

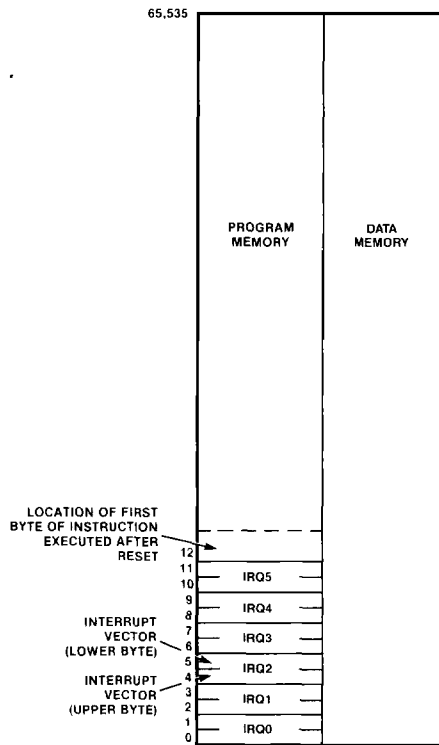

Figure 4. Program Memory Map

DEC	HEX	IDENTIFIERS
255	FF	SPL
254	FE	SPH
253	FD	RP
252	FC	FLAGS
251	FB	IMR
250	FA	IRQ
249	F9	IPR
248	F8	P01M
247	F7	P3M
246	F6	P2M
245	F5	PRE0
244	F4	T0
243	F3	PRE1
242	F2	T1
241	F1	TMR
240	F0	SIO
NOT IMPLEMENTED		
127	7F	
GENERAL PURPOSE REGISTERS		
4	04	
3	03	P3
2	02	P2
1	01	P1
0	00	P0

Figure 5. The Register File

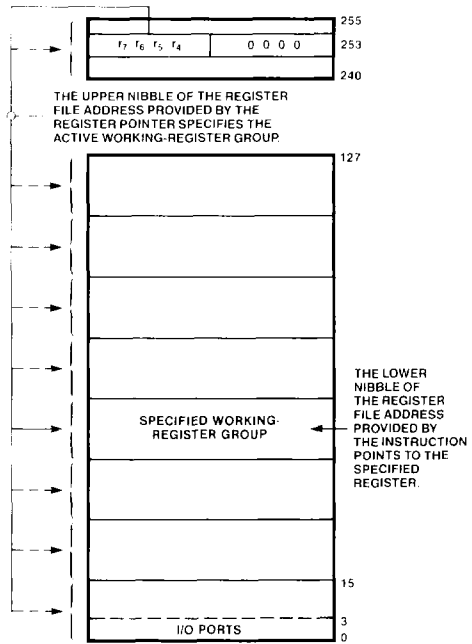

Figure 6. The Register Pointer

## SERIAL INPUT/OUTPUT

Port 3 lines P3<sub>0</sub> and P3<sub>7</sub> can be programmed as serial I/O lines for full-duplex serial asynchronous receiver/transmitter operation. The bit rate is controlled by Counter/Timer 0, with a maximum rate of 62.5K bits/second at 8 MHz or 93.75K bits/second at 12 MHz on the Z8691.

The Z8691 automatically adds a start bit and two stop bits to transmitted data (Figure 7). Odd parity is also available as an option. Eight data bits are always transmitted, regardless of

parity selection. If parity is enabled, the eighth data bit is used as the odd parity bit. An interrupt request (IRQ4) is generated on all transmitted characters.

Received data must have a start bit, eight data bits, and at least one stop bit. If parity is on, bit 7 of the received data is replaced by a parity error flag. Received characters generate the IRQ3 interrupt request.

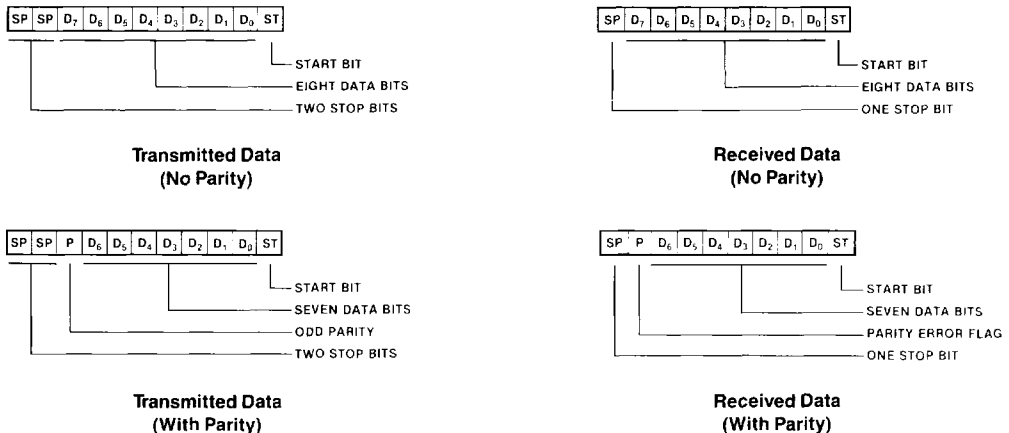

Figure 7. Serial Data Formats

## COUNTER/TIMERS

The Z8691 contains two 8-bit programmable counter/timers ( $T_0$  and  $T_1$ ), each driven by its own 6-bit programmable prescaler. The  $T_1$  prescaler can be driven by internal or external clock sources; however, the  $T_0$  prescaler is driven by the internal clock only.

The 6-bit prescalers can divide the input frequency of the clock source by any number from 1 to 64. Each prescaler drives its counter, which decrements the value (1 to 256) that has been loaded into the counter. When the counter reaches the end of count, a timer interrupt request—IRQ4 ( $T_0$ ) or IRQ5 ( $T_1$ )—is generated.

The counters can be started, stopped, restarted to continue, or restarted from the initial value. The counters can also be programmed to stop upon reaching zero (single-pass mode)

or to automatically reload the initial value and continue counting (modulo-n continuous mode). The counters, but not the prescalers, can be read any time without disturbing their value or count mode.

The clock source for  $T_1$  is user-definable; it can be either the internal microprocessor clock divided by four, or an external signal input via Port 3. The Timer Mode register configures the external timer input as an external clock, a trigger input that can be retriggerable or nonretriggerable, or as a gate input for the internal clock. The counter/timers can be programmably cascaded by connecting the  $T_0$  output to the input of  $T_1$ . Port 3 line  $P3_6$  also serves as a timer output ( $T_{OUT}$ ) through which  $T_0$ ,  $T_1$  or the internal clock can be output.

## I/O PORTS

The Z8691 has 24 lines available for input and output. These lines are grouped into three ports of eight lines each and are configurable as input, output or address. Under software control, the ports can be programmed to provide address

outputs, timing, status signals, serial I/O, and parallel I/O with or without handshake. All ports have active pull-ups and pull-downs compatible with TTL loads.

**Port 1** is a dedicated Z-BUS compatible memory interface. The operations of Port 1 are supported by the Address Strobe ( $\overline{AS}$ ) and Data Strobe ( $\overline{DS}$ ) lines, and by the Read/Write (R/W) and Data Memory ( $\overline{DM}$ ) control lines. The low-order program and data memory addresses ( $A_0$ - $A_7$ ) are output through Port 1 (Figure 8) and are multiplexed with data in/output ( $D_0$ - $D_7$ ). Instruction fetch and data memory read/write operations are done through this port.

Port 1 cannot be used as a register nor can a handshake mode be used with this port.

The Z8691 wakes up with the 8 bits of Port 1 configured as address outputs for external memory. If more than eight address lines are required, additional lines can be obtained by programming Port 0 bits as address bits. The

least-significant four bits of Port 0 can be configured to supply address bits  $A_8$ - $A_{11}$  for 4K byte addressing or both nibbles of Port 0 can be configured to supply address bits  $A_8$ - $A_{15}$  for 64K byte addressing.

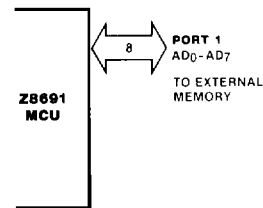

Figure 8. Port 1

**Port 0** can be programmed as a nibble I/O port, or as an address port for interfacing external memory (Figure 9). When used as an I/O port, Port 0 can be placed under handshake control. In this configuration, Port 3 lines  $P3_2$  and  $P3_5$  are used as the handshake controls  $DAV_0$  and  $RDY_0$ . Handshake signal assignment is dictated by the I/O direction of the upper nibble  $P0_4$ - $P0_7$ .

For external memory references, Port 0 can provide address bits  $A_8$ - $A_{11}$  (lower nibble) or  $A_8$ - $A_{15}$  (lower and upper nibbles) depending on the required address space. If the address range requires 12 bits or less, the upper nibble of Port 0 can be programmed independently as I/O while the lower nibble is used for addressing.

Port 0 lines are configured as address lines  $A_8$ - $A_{15}$  after a reset. If one or both nibbles are needed for I/O operation, they must be configured by writing to the Port 0 Mode register.

To permit the use of slow memory, an automatic wait mode of two oscillator clock cycles is configured for the bus timing of the Z8691 after each reset. The initialization routine could include reconfiguration to eliminate this extended timing mode.

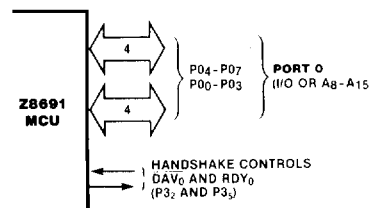

Figure 9. Port 0

**Port 2** bits can be programmed independently as input or output (Figure 10). This port is always available for I/O operations. In addition, Port 2 can be configured to provide open-drain outputs.

Port 2 may also be placed under handshake control. In this configuration, Port 3 lines P3<sub>1</sub> and P3<sub>6</sub> are used as the handshake controls lines  $\overline{DAV}_2$  and RDY<sub>2</sub>. The handshake signal assignment for Port 3 lines P3<sub>1</sub> and P3<sub>6</sub> is dictated by the direction (input or output) assigned to bit 7 of Port 2.

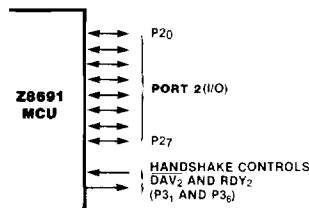

Figure 10. Port 2

**Port 3** lines can be configured as I/O or control lines (Figure 11). In either case, the direction of the eight lines is fixed as four input (P3<sub>0</sub>-P3<sub>3</sub>) and four output (P3<sub>4</sub>-P3<sub>7</sub>). For serial I/O, lines P3<sub>0</sub> and P3<sub>7</sub> are programmed as serial in and serial out, respectively.

Port 3 can also provide the following control functions: handshake for Ports 0 and 2 ( $\overline{DAV}$  and RDY); four external interrupt request signals (IRQ0-IRQ3); timer input and output signals (T<sub>IN</sub> and T<sub>OUT</sub>) and Data Memory Select ( $\overline{DM}$ ).

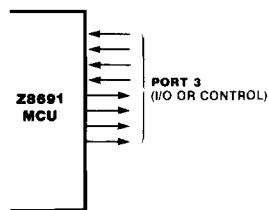

Figure 11. Port 3

## INTERRUPTS

The Z8691 allows six different interrupts from eight sources: the four Port 3 lines P3<sub>0</sub>-P3<sub>3</sub>, Serial In, Serial Out, and the two counter/timers. These interrupts are both maskable and prioritized. The Interrupt Mask register globally or individually enables or disables the six interrupt requests. When more than one interrupt is pending, priorities are resolved by a programmable priority encoder that is controlled by the Interrupt Priority register.

All interrupts are vectored through locations in program memory. When an interrupt request is granted, an interrupt machine cycle is entered. This disables all subsequent

interrupts, saves the Program Counter and status flags, and accesses the program memory vector location reserved for that interrupt. This memory location and the next byte contain the 16-bit address of the interrupt service routine for that particular interrupt request. The Z8691 takes 63 crystal cycles to enter an interrupt subroutine.

Polled interrupt systems are also supported. To accommodate a polled structure, any or all of the interrupt inputs can be masked and the Interrupt Request register polled to determine which of the interrupt requests needs service.

## CLOCK

The on-chip oscillator has a high-gain, parallel-resonant amplifier for connection to a crystal or to any suitable external clock source (XTAL1 = Input, XTAL2 = Output).

The crystal source is connected across XTAL1 and XTAL2, using the recommended capacitance ( $C_L = 15$  pf maximum) from each pin to ground. The specifications for the crystal are as follows:

- AT cut, parallel-resonant
- Fundamental type
- Series resistance,  $R_s \leq 100 \Omega$
- 8 or 12 MHz maximum

## INSTRUCTION SET NOTATION

**Addressing Modes.** The following notation is used to describe the addressing modes and instruction operations as shown in the instruction summary.

<b>IRR</b>	Indirect register pair or indirect working-register pair address
<b>Irr</b>	Indirect working-register pair only
<b>X</b>	Indexed address
<b>DA</b>	Direct address
<b>RA</b>	Relative address
<b>IM</b>	Immediate
<b>R</b>	Register or working-register address
<b>r</b>	Working-register address only
<b>IR</b>	Indirect-register or indirect working-register address
<b>Ir</b>	Indirect working-register address only
<b>RR</b>	Register pair or working register pair address

**Symbols.** The following symbols are used in describing the instruction set.

<b>dst</b>	Destination location or contents
<b>src</b>	Source location or contents
<b>cc</b>	Condition code (see list)
<b>@</b>	Indirect address prefix
<b>SP</b>	Stack pointer (control registers 254-255)
<b>PC</b>	Program counter
<b>FLAGS</b>	Flag register (control register 252)
<b>RP</b>	Register pointer (control register 253)
<b>IMR</b>	Interrupt mask register (control register 251)

Assignment of a value is indicated by the symbol " $\leftarrow$ ". For example,

$$\text{dst} \leftarrow \text{dst} + \text{src}$$

indicates that the source data is added to the destination data and the result is stored in the destination location. The notation "addr(n)" is used to refer to bit "n" of a given location. For example,

$$\text{dst}(7)$$

refers to bit 7 of the destination operand.

**Flags.** Control Register R252 contains the following six flags:

<b>C</b>	Carry flag
<b>Z</b>	Zero flag
<b>S</b>	Sign flag
<b>V</b>	Overflow flag
<b>D</b>	Decimal-adjust flag
<b>H</b>	Half-carry flag

Affected flags are indicated by:

<b>0</b>	Cleared to zero
<b>1</b>	Set to one
<b>*</b>	Set or cleared according to operation
<b>—</b>	Unaffected
<b>X</b>	Undefined

## CONDITION CODES

Value	Mnemonic	Meaning	Flags Set
1000		Always true	—
0111	C	Carry	C = 1
1111	NC	No carry	C = 0
0110	Z	Zero	Z = 1
1110	NZ	Not zero	Z = 0
1101	PL	Plus	S = 0
0101	MI	Minus	S = 1
0100	OV	Overflow	V = 1
1100	NOV	No overflow	V = 0
0110	EQ	Equal	Z = 1
1110	NE	Not equal	Z = 0
1001	GE	Greater than or equal	(S XOR V) = 0
0001	LT	Less than	(S XOR V) = 1
1010	GT	Greater than	[Z OR (S XOR V)] = 0
0010	LE	Less than or equal	[Z OR (S XOR V)] = 1
1111	UGE	Unsigned greater than or equal	C = 0
0111	ULT	Unsigned less than	C = 1
1011	UGT	Unsigned greater than	(C = 0 AND Z = 0) = 1
0011	ULE	Unsigned less than or equal	(C OR Z) = 1
0000		Never true	—



# INSTRUCTION FORMATS

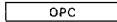

CCF, DI, EI, IRET, NOP,  
RCF, RET, SCF

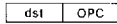

INC r

## One-Byte Instruction

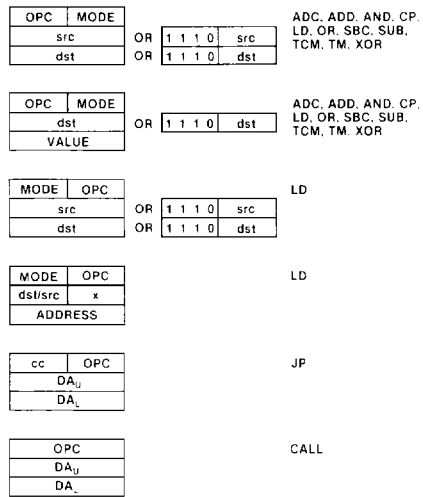
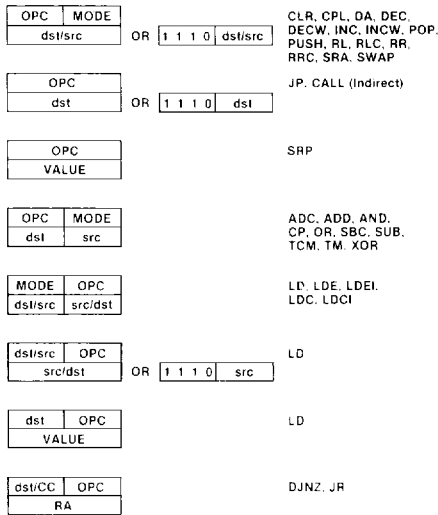

## Two-Byte Instruction

## Three-Byte Instruction

Figure 12. Instruction Formats

# INSTRUCTION SUMMARY

Instruction and Operation	Addr Mode		Opcode Byte (Hex)	Flags Affected						
	dst	src		C	Z	S	V	D	H	
<b>ADC</b> dst,src dst ← dst + src + C	(Note 1)		1	*	*	*	*	0	*	
<b>ADD</b> dst,src dst ← dst + src	(Note 1)		0	*	*	*	*	0	*	
<b>AND</b> dst,src dst ← dst AND src	(Note 1)		5	-	*	*	0	-	-	-
<b>CALL</b> dst SP ← SP - 2 @SP ← PC, PC ← dst	DA		D6	-	-	-	-	-	-	-
	IR		D4	-	-	-	-	-	-	-
<b>CCF</b> C ← NOT C			EF	*						
<b>CLR</b> dst dst ← 0	R		B0							
	IR		B1							
<b>COM</b> dst dst ← NOT dst	R		60	-	*	*	0			
	IR		61	-	*	*	0			
<b>CP</b> dst,src dst - src	(Note 1)		A	*	*	*	*	-		
<b>DA</b> dst dst ← DA, dst	R		40	*	*	*	X			
	IR		41	*	*	*	X			

Instruction and Operation	Addr Mode		Opcode Byte (Hex)	Flags Affected						
	dst	src		C	Z	S	V	D	H	
<b>DEC</b> dst dst ← dst - 1	R		00	-	*	*	*	-	-	-
	IR		01	-	*	*	*	-	-	-
<b>DECW</b> dst dst ← dst - 1	RR		80	*	*	*	*	-	-	-
	IR		81	*	*	*	*	-	-	-
<b>DI</b> IMR(7) ← 0			8F	-	-	-	-	-	-	-
<b>DJNZ</b> r, dst r ← r - 1 if r ≠ 0 PC ← PC + dst Range: +127, -128	RA		rA	-	-	-	-	-	-	-
			r = 0 - F							
<b>EI</b> IMR(7) ← 1			9F	-	-	-	-	-	-	-
<b>INC</b> dst dst ← dst + 1	r		rE	*	*	*	*	-		
	R		r = 0 - F							
	IR		20							
	IR		21							
<b>INCW</b> dst dst ← dst + 1	RR		A0	-	*	*	*	*	-	-
	IR		A1	-	*	*	*	*	-	-



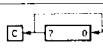

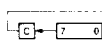
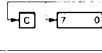
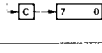
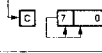
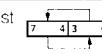

## INSTRUCTION SUMMARY (Continued)

Instruction and Operation	Addr Mode		Opcode Byte (Hex)	Flags Affected					
	dst	src		C	Z	S	V	D	H
<b>IRET</b> FLAGS ← @SP; SP ← SP + 1 PC ← @SP; SP ← SP + 2; IMR(7) ← 1			BF	*	*	*	*	*	*
<b>JP</b> cc, dst if cc is true PC ← dst	DA		cD 30	c = 0 - F					
<b>JR</b> cc, dst if cc is true. PC ← PC + dst Range: +127, -128	RA		cB	c = 0 - F					
<b>LD</b> dst, src dst ← src	r R R	lm R r	rC r8 r9						
				r = 0 - F					
	r	X	C7						
	X	r	D7						
	r	lr	E3						
	lr	r	F3						
	R	R	E4						
	R	IR	E5						
	R	IM	E6						
	IR	IM	E7						
	IR	R	F5						
<b>LDC</b> dst, src dst ← src	r lrr	lrr r	C2 D2						
<b>LDCI</b> dst, src dst ← src	lr lrr	lrr lr	C3 D3						
				r ← r + 1; rr ← rr + 1					
<b>LDE</b> dst, src dst ← src	r lrr	lrr r	82 92						
<b>LDEI</b> dst, src dst ← src	lr lrr	lrr lr	83 93						
				r ← r + 1; rr ← rr + 1					
<b>NOP</b>			FF						
<b>OR</b> dst, src dst ← dst OR src		(Note 1)	4	*	*	0			
<b>POP</b> dst dst ← @SP; SP ← SP + 1	R IR		50 51						
<b>PUSH</b> src SP ← SP - 1; @SP ← src	R IR		70 71						
<b>RCF</b> C ← 0			CF	0					
<b>RET</b> PC ← @SP; SP ← SP + 2			AF						
<b>RL</b> dst		R IR	90 91	*	*	*	*	*	

Instruction and Operation	Addr Mode		Opcode Byte (Hex)	Flags Affected					
	dst	src		C	Z	S	V	D	H
<b>RLC</b> dst		R IR	10 11	*	*	*	*	*	
<b>RR</b> dst		R IR	E0 E1	*	*	*	*	*	
<b>RRC</b> dst		R IR	C0 C1	*	*	*	*	*	
<b>SBC</b> dst, src dst ← dst ← src ← C		(Note 1)	3F	*	*	*	*	1	*
<b>SCF</b> C ← 1			DF	1					
<b>SRA</b> dst		R IR	D0 D1	*	*	*	0		
<b>SRP</b> src RP ← src		lm	31						
<b>SUB</b> dst, src dst ← dst ← src		(Note 1)	2F	*	*	*	*	1	*
<b>SWAP</b> dst		R IR	F0 F1	X	*	*	X		
<b>TCM</b> dst, src (NOT dst) AND src		(Note 1)	6F		*	*	0		
<b>TM</b> dst, src dst AND src		(Note 1)	7F		*	*	0		
<b>XOR</b> dst, src dst ← dst XOR src		(Note 1)	B7		*	*	0		

NOTE: These instructions have an identical set of addressing modes, which are encoded for brevity. The first opcode nibble is found in the instruction set table above. The second nibble is expressed symbolically by a *r* in this table, and its value is found in the following table to the left of the applicable addressing mode bar.

For example, the opcode of an ADC instruction using the addressing modes *r* (destination) and *lr* (source) is 13.

Addr Mode		Lower Opcode Nibble
dst	src	
<i>r</i>	<i>r</i>	
<i>r</i>	<i>lr</i>	
R	R	
R	IR	
R	IM	
IR	IM	

# REGISTERS

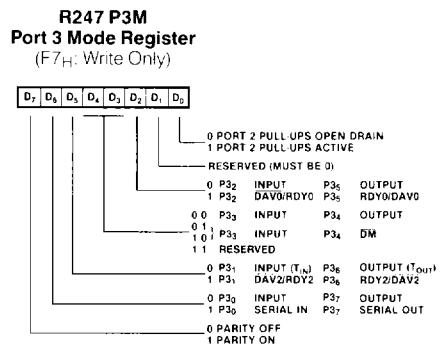
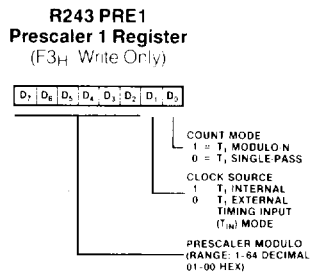
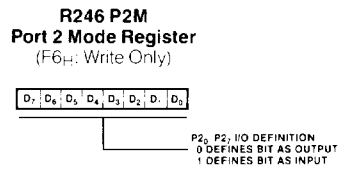
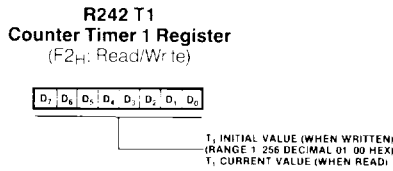
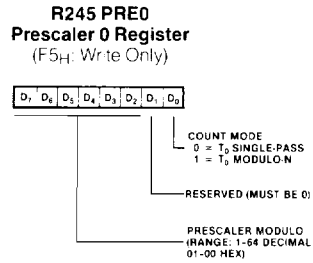
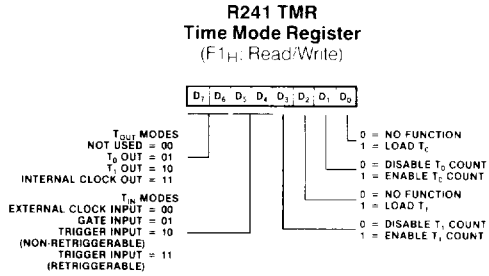
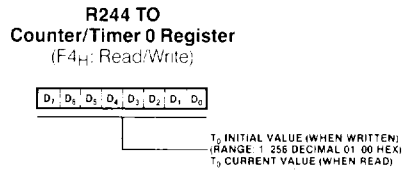
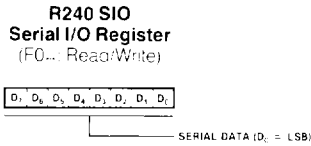
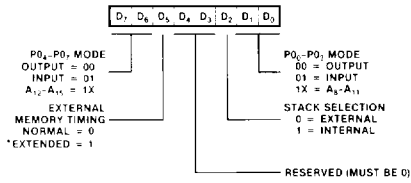

Figure 13. Control Registers

# REGISTERS

(Continued)

## R248 P01M Port 0 Mode Register (F8H; Write Only)



\*ALWAYS EXTENDED TIMING AFTER RESET

## R252 FLAGS Flag Register (FC<sub>H</sub>; Read/Write)

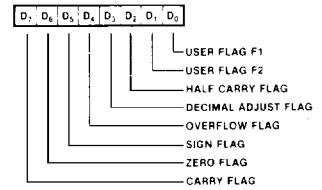

## R249 IPR Interrupt Priority Register (F9H; Write Only)

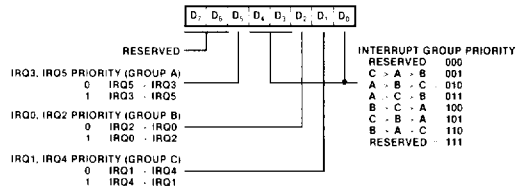

## R253 RP Register Pointer (FDH; Read/Write)

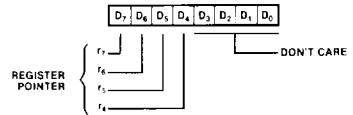

## R250 IRQ Interrupt Request Register (FAH; Read/Write)

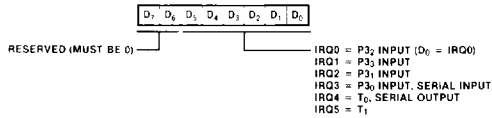

## R254 SPH Stack Pointer (FEH; Read/Write)

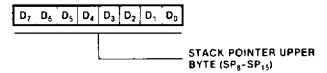

## R251 IMR Interrupt Mask Register (FBH; Read/Write)

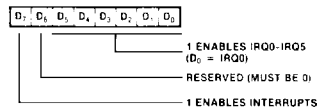

## R255 SPL Stack Pointer (FFH; Read/Write)

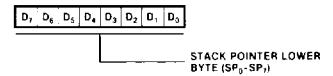
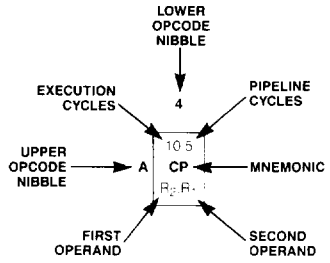

Figure 13. Control Registers (Continued)

# OPCODE MAP

		Lower Nibble (Hex)															
		0	1	2	3	4	5	6	7	8	9	A	B	C	D	E	F
Upper Nibble (Hex)	0	6.5 DEC R-	6.5 DEC IR <sub>1</sub>	6.5 ADD r <sub>1</sub> , r <sub>2</sub>	6.5 ADD r <sub>1</sub> , r <sub>2</sub>	10.5 ADD R <sub>2</sub> , R <sub>1</sub>	10.5 ADD IR <sub>2</sub> , R <sub>1</sub>	10.5 ADD R-, IM	10.5 ADD R <sub>1</sub> , IM	6.5 LD r <sub>1</sub> , R <sub>2</sub>	6.5 LD r <sub>2</sub> , R <sub>1</sub>	12.10.5 DJNZ r-, RA	12.10.0 JR cc, RA	6.5 LD r <sub>1</sub> , IM	12.10.0 JP cc, DA	6.5 INC r <sub>1</sub>	
	1	6.5 RLC R-	6.5 RLC IR <sub>1</sub>	6.5 ADC r <sub>1</sub> , r <sub>2</sub>	6.5 ADC r <sub>1</sub> , r <sub>2</sub>	10.5 ADC R <sub>2</sub> , R <sub>1</sub>	10.5 ADC IR <sub>2</sub> , R <sub>1</sub>	10.5 ADC R <sub>1</sub> , IM	10.5 ADC R <sub>1</sub> , IM								
	2	6.5 INC R <sub>1</sub>	6.5 INC IR <sub>1</sub>	6.5 SUB r <sub>1</sub> , r <sub>2</sub>	6.5 SUB r <sub>1</sub> , r <sub>2</sub>	10.5 SUB R <sub>2</sub> , R <sub>1</sub>	10.5 SUB IR <sub>2</sub> , R <sub>1</sub>	10.5 SUB R <sub>1</sub> , IM	10.5 SUB R <sub>1</sub> , IM								
	3	8.0 JP IR, R <sub>1</sub>	6.1 SRP IM	6.5 SBC r <sub>1</sub> , r <sub>2</sub>	6.5 SBC r <sub>1</sub> , r <sub>2</sub>	10.5 SBC R <sub>2</sub> , R <sub>1</sub>	10.5 SBC IR <sub>2</sub> , R <sub>1</sub>	10.5 SBC R <sub>1</sub> , IM	10.5 SBC R <sub>1</sub> , IM								
	4	8.5 DA R <sub>1</sub>	8.5 DA IR <sub>1</sub>	6.5 OR r <sub>1</sub> , r <sub>2</sub>	6.5 OR r <sub>1</sub> , r <sub>2</sub>	10.5 OR R <sub>2</sub> , R <sub>1</sub>	10.5 OR IR <sub>2</sub> , R <sub>1</sub>	10.5 OR R <sub>1</sub> , IM	10.5 OR R <sub>1</sub> , IM								
	5	10.5 POP R <sub>1</sub>	10.5 POP IR <sub>1</sub>	6.5 AND r <sub>1</sub> , r <sub>2</sub>	6.5 AND r <sub>1</sub> , r <sub>2</sub>	10.5 AND R <sub>2</sub> , R <sub>1</sub>	10.5 AND IR <sub>2</sub> , R <sub>1</sub>	10.5 AND R <sub>1</sub> , M	10.5 AND R <sub>1</sub> , M								
	6	6.5 COM R <sub>1</sub>	6.5 COM IR <sub>1</sub>	6.5 TCM r <sub>1</sub> , r <sub>2</sub>	6.5 TCM r <sub>1</sub> , r <sub>2</sub>	10.5 TCM R <sub>2</sub> , R <sub>1</sub>	10.5 TCM IR <sub>2</sub> , R <sub>1</sub>	10.5 TCM R <sub>1</sub> , M	10.5 TCM R <sub>1</sub> , M								
	7	10.12.1 PUSH R <sub>2</sub>	12.14.1 PUSH IR <sub>2</sub>	6.5 TM r <sub>1</sub> , r <sub>2</sub>	6.5 TM r <sub>1</sub> , r <sub>2</sub>	10.5 TM R <sub>2</sub> , R <sub>1</sub>	10.5 TM IR <sub>2</sub> , R <sub>1</sub>	10.5 TM R <sub>1</sub> , M	10.5 TM R <sub>1</sub> , M								
	8	10.5 DECW RR-	10.5 DECW R-	12.0 LDE r <sub>1</sub> , IR <sub>2</sub>	18.0 LDEI r <sub>1</sub> , IR <sub>2</sub>												6.1 DI
	9	6.5 RL R <sub>1</sub>	6.5 RL IR <sub>1</sub>	12.0 LDE r <sub>2</sub> , IR <sub>1</sub>	18.0 LDEI r <sub>2</sub> , IR <sub>1</sub>												6.1 EI
	A	10.5 INCW RR <sub>1</sub>	10.5 INCW IR-	6.5 CP r <sub>1</sub> , r <sub>2</sub>	6.5 CP r <sub>1</sub> , r <sub>2</sub>	10.5 CP R <sub>2</sub> , R <sub>1</sub>	10.5 CP R <sub>1</sub> , R <sub>1</sub>	10.5 CP R-, IM	10.5 CP R <sub>1</sub> , IM								14.C RET
	B	6.5 CLR R <sub>1</sub>	6.5 CLR IR-	6.5 XOR r <sub>1</sub> , r <sub>2</sub>	6.5 XOR r <sub>1</sub> , r <sub>2</sub>	10.5 XOR R <sub>2</sub> , R <sub>1</sub>	10.5 XOR R <sub>2</sub> , R-	10.5 XOR R-, IM	10.5 XOR R <sub>1</sub> , IM								16.C IRET
	C	6.5 RRC R <sub>1</sub>	6.5 RRC IR-	12.0 LDC r <sub>1</sub> , IR <sub>2</sub>	18.0 LDCI r <sub>1</sub> , IR <sub>2</sub>				10.5 LD r <sub>1</sub> x R <sub>2</sub>								6.5 RCF
	D	6.5 SRA R <sub>1</sub>	6.5 SRA IR <sub>1</sub>	12.0 LDC r <sub>2</sub> , IR <sub>1</sub>	18.0 LDCI r <sub>2</sub> , IR <sub>1</sub>	20.0 CALL* IRR <sub>1</sub>		20.0 CALL DA	10.5 LD r <sub>2</sub> x R-								6.5 SCF
	E	6.5 RR R-	6.5 RR IR <sub>1</sub>		6.5 LD r <sub>1</sub> , IR <sub>2</sub>	10.5 LD R <sub>2</sub> , R <sub>1</sub>	10.5 LD IR <sub>2</sub> , R-	10.5 LD R-, IM	10.5 LD R <sub>1</sub> , IM								6.5 CCF
	F	8.5 SWAP R-	8.5 SWAP IR-		6.5 LD r <sub>1</sub> , r <sub>2</sub>		10.5 LD R <sub>2</sub> , IR <sub>1</sub>										6.0 NOP



**Legend:**  
R = 8-bit address  
r = 4-bit address  
R<sub>1</sub> or r<sub>1</sub> = Dest address  
R<sub>2</sub> or r<sub>2</sub> = Src address

**Sequence:**  
Opcode, First Operand, Second Operand

**NOTE:** The blank areas are not defined.

\*2 byte instruction; fetch cycle appears as a 3-byte instruction

## ABSOLUTE MAXIMUM RATINGS

Voltages on all pins except RESET  
 with respect to GND . . . . . -0.3V to +7.0V  
 Operating Ambient  
 Temperature . . . . . See Ordering Information  
 Storage Temperature . . . . . -65°C to +150°C

Stresses greater than those listed under Absolute Maximum Ratings may cause permanent damage to the device. This is a stress rating only; operation of the device at any condition above those indicated in the operational sections of these specifications is not implied. Exposure to absolute maximum rating conditions for extended periods may affect device reliability.

## STANDARD TEST CONDITIONS

The DC characteristics listed below apply for the following standard test conditions, unless otherwise noted. All voltages are referenced to GND. Positive current flows into the referenced pin.

Standard conditions are as follows:

- $+4.75V \leq V_{CC} \leq +5.25V$
- $GND = 0V$
- $0^\circ C \leq T_A \leq +70^\circ C$  for S (Standard temperature)
- $-40^\circ C \leq T_A \leq +100^\circ C$  for E (Extended temperature)

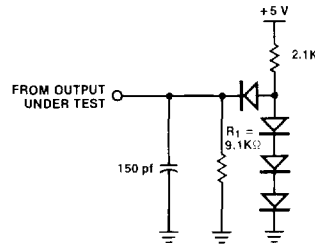

Figure 14. Test Load 1

## DC CHARACTERISTICS

Symbol	Parameter	Min	Max	Unit	Condition
$V_{CH}$	Clock Input High Voltage	3.8	$V_{CC}$	V	Driven by External Clock Generator
$V_{CL}$	Clock Input Low Voltage	-0.3	0.8	V	Driven by External Clock Generator
$V_{IH}$	Input High Voltage	2.0	$V_{CC}$	V	
$V_{IL}$	Input Low Voltage	-0.3	0.8	V	
$V_{RH}$	Reset Input High Voltage	3.8	$V_{CC}$	V	
$V_{RL}$	Reset Input Low Voltage	-0.3	0.8	V	
$V_{OH}$	Output High Voltage	2.4		V	$I_{OH} = -250 \mu A$
$V_{OL}$	Output Low Voltage		0.4	V	$I_{OL} = +2.0 \text{ mA}$
$I_{IL}$	Input Leakage	-10	10	$\mu A$	$V_{IN} = 0V, 5.25V$
$I_{OL}$	Output Leakage	-10	10	$\mu A$	$V_{IN} = 0V, 5.25V$
$I_{IR}$	Reset Input Current		-50	$\mu A$	$V_{CC} = +5.25V, V_{RL} = 0V$
$I_{CC}$	$V_{CC}$ Supply Current		180	mA	All outputs and I/O pins floating

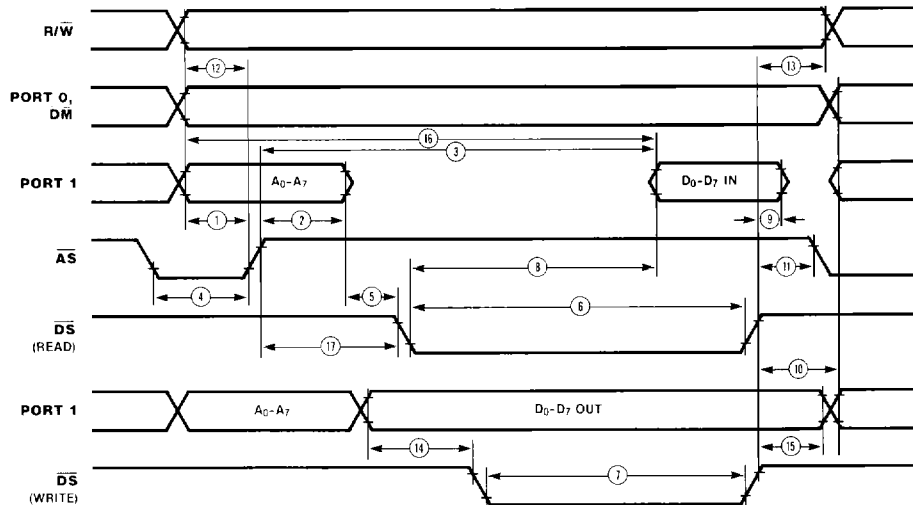

Figure 15. External I/O or Memory Read/Write Timing

## AC CHARACTERISTICS

External I/O or Memory Read and Write Timing

Number	Symbol	Parameter	8 MHz		12 MHz		Notes*†°
			Min	Max	Min	Max	
1	TdA(AS)	Address Valid to $\overline{AS}$ $\uparrow$ Delay	50		35		2,3
2	TdAS(A)	$\overline{AS}$ $\uparrow$ to Address Float Delay	70		45		2,3
3	TdAS(DR)	$\overline{AS}$ $\uparrow$ to Read Data Required Valid		360		220	1,2,3
4	TwAS	$\overline{AS}$ Low Width	80		55		2,3
5	TdAz(DS)	Address Float to $\overline{DS}$ $\downarrow$	0		0		
6	TwDSR	$\overline{DS}$ (Read) Low Width	250		185		1,2,3
7	TwDSW	$\overline{DS}$ (Write) Low Width	160		110		1,2,3
8	TdDSR(DR)	$\overline{DS}$ $\downarrow$ to Read Data Required Valid		200		130	1,2,3
9	ThDR(DS)	Read Data to $\overline{DS}$ $\uparrow$ Hold Time	0		0		
10	TdDS(A)	$\overline{DS}$ $\uparrow$ to Address Active Delay	70		45		2,3
11	TdDS(AS)	$\overline{DS}$ $\uparrow$ to $\overline{AS}$ $\downarrow$ Delay	70		55		2,3
12	TdR/W(AS)	$R/\overline{W}$ Valid to $\overline{AS}$ $\uparrow$ Delay	50		30		2,3
13	TdDS(R/W)	$\overline{DS}$ $\uparrow$ to R/W Not Valid	60		35		2,3
14	TdDW(DSW)	Write Data Valid to $\overline{DS}$ (Write) $\downarrow$ Delay	50		35		2,3
15	TdDS(DW)	$\overline{DS}$ $\uparrow$ to Write Data Not Valid Delay	60		35		2,3
16	TdA(DR)	Address Valid to Read Data Required Valid		410		255	1,2,3
17	TdAS(DS)	$\overline{AS}$ $\uparrow$ to $\overline{DS}$ $\downarrow$ Delay	80		55		2,3

NOTES:

- When using extended memory timing add 2 T<sub>PC</sub>.
- Timing numbers given are for minimum T<sub>PC</sub>.
- See clock cycle time dependent characteristics table.

\* All units in nanoseconds (ns).

† Test Load 1

° All timing references use 2.0V for a logic "1" and 0.8V for a logic "0".

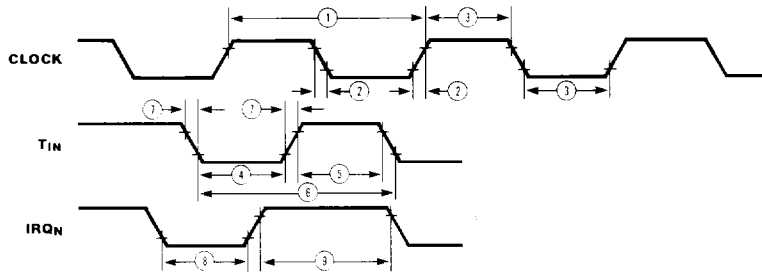

Figure 16. Additional Timing

## AC CHARACTERISTICS

### Additional Timing Table

Number	Symbol	Parameter	8 MHz		12 MHz		Notes*
			Min	Max	Min	Max	
1	TpC	Input Clock Period	125	1000	83	1000	1
2	TrC, TfC	Clock Input Rise and Fall Times		25		15	1
3	TwC	Input Clock Width	37		70		1
4	TwTinL	Timer Input Low Width	100		70		2
5	TwTinH	Timer Input High Width	3TpC		3TpC		2
6	TpTin	Timer Input Period	8TpC		8TpC		2
7	TrTin, TfTin	Timer Input Rise and Fall Times		100		100	2
8A	TwIL	Interrupt Request Input Low Time	100		70		2,4
8B	TwIL	Interrupt Request Input Low Time	3TpC		3TpC		2,5
9	TwIH	Interrupt Request Input High Time	3TpC		3TpC		2,3

#### NOTES:

1. Clock timing references use 3.8V for a logic "1" and 0.8V for a logic "0".
  2. Timing references use 2.0V for a logic "1" and 0.8V for a logic "0".
  3. Interrupt request via Port 3.
  4. Interrupt request via Port 3 (P3<sub>1</sub>-P3<sub>3</sub>)
  5. Interrupt request via Port 3 (P3<sub>0</sub>)
- \* Units in nanoseconds (ns).



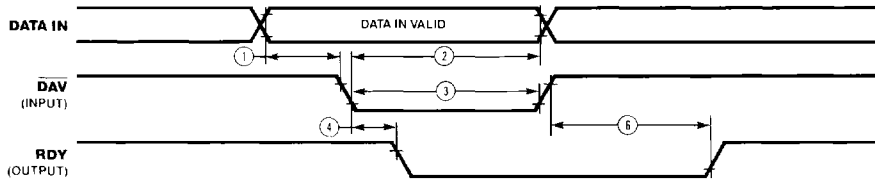

Figure 17a. Input Handshake Timing

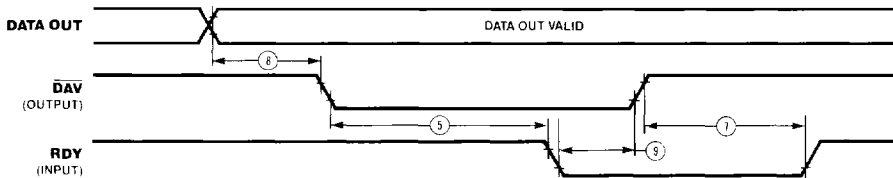

Figure 17b. Output Handshake Timing

## AC CHARACTERISTICS

### Handshake Timing

Number	Symbol	Parameter	8 MHz		12 MHz		Notes†*
			Min	Max	Min	Max	
1	TsDI(DAV)	Data In Setup Time	0		0		
2	ThDI(DAV)	Data In Hold Time	230		160		
3	TwDAV	Data Available Width	175		120		
4	TdDAVI(RDY)	$\overline{\text{DAV}} \downarrow$ Input to RDY $\downarrow$ Delay		175		120	1,2
5	TdDAVO(RDY)	$\overline{\text{DAV}} \downarrow$ Output to RDY $\downarrow$ Delay	0		0		1,3
6	TdDAVIr(RDY)	$\overline{\text{DAV}} \uparrow$ Input to RDY $\uparrow$ Delay		175		120	1,2
7	TdDAVOr(RDY)	$\overline{\text{DAV}} \uparrow$ Output to RDY $\uparrow$ Delay	0		0		1,3
8	TdDO(DAV)	Data Out to $\overline{\text{DAV}} \downarrow$ Delay	50		30		1
9	TdRDY(DAV)	Rdy $\downarrow$ Input to $\overline{\text{DAV}} \uparrow$ Delay	0	200	0	140	1

#### NOTES:

1. Test load 1

2. Input handshake

3. Output handshake

† All timing references use 2.0V for a logic "1" and 0.8V for a logic "0".

\* Units in nanoseconds (ns).

## CLOCK CYCLE TIME-DEPENDENT CHARACTERISTICS

Number	Symbol	8 MHz Equation	12 MHz Equation
1	TdA(AS)	TpC-75	TpC-50
2	TdAS(A)	TpC-55	TpC-40
3	TdAS(DR)	4TpC-140*	4TpC-110*
4	TwAS	TpC-45	TpC-30
6	TwDSR	3TpC-125*	3TpC-65*
7	TwDSW	2TpC-90*	2TpC-55*
8	TdDSR(DR)	3TpC-175*	3TpC-120*
10	Td(DS)A	TpC-55	TpC-40
11	TdDS(AS)	TpC-55	TpC-30
12	TdR/W(AS)	TpC-75	TpC-55
13	TdDS(R/W)	TpC-65	TpC-50
14	TdDW(DSW)	TpC-75	TpC-50
15	TdDS(DW)	TpC-55	TpC-40
16	TdA(DR)	5TpC-215*	5TpC-160*
17	TdAS(DS)	TpC-45	TpC-30

\*Add 2TpC when using extended memory timing