

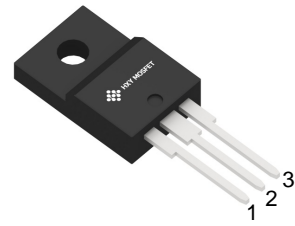

Features

- Low power loss,high efficiency.
- High surge capacity
- For use in low voltage,high frequency inverters, free wheeling,and polarity protection applications.
- Metal silicon junction,majority carrier conduction.
- High current Capability,low forward voltage drop.
- Guard ring for over voltage protection.



**TO-220F
(ITO-220AB-3)
PIN CONNECTIONS**

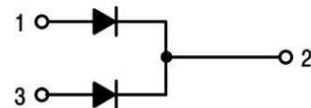

Absolute Maximum Ratings (T_c=25°C)

PARAMETER	Symbol	MBRF 2040 CT	MBRF 2045 CT	MBRF 2050 CT	MBRF 2060 CT	MBRF 2080 CT	MBRF 2090 CT	MBRF 20100 CT	MBRF 20150 CT	MBRF 20200 CT	Unit
Maximum Recurrent Peak Reverse Voltage	V _{RRM}	40	45	50	60	80	90	100	150	200	V
Maximum RMS Voltage	V _{RMS}	28	31.5	35	42	56	63	70	105	140	V
Maximum DC Blocking Voltage	V _{R(DC)}	40	45	50	60	80	90	100	150	200	V
Maximum Average Forward Current	I _{F(AV)}	20									A
Peak Forward Surge Current:8.3ms single half sine-wave superimposed on rated load (JEDEC method)	I _{FSM}	175									A
Maximum Forward Voltage at 10A per leg	V _F	0.65	0.72		0.85		0.95				V
Maximum DC Reverse Current at Rated DC Blocking Voltage	T _j =25°C	0.1									mA
	T _j =125°C	20									mA
Maximum Operating Junction Temperature	T _j	150				175					°C
Storage Temperature	T _{stg}	-55~+ 150				-65~+175					°C
Typical Thermal Resistance	R _{θJC}	1.4									°C/W



Typical Characteristics

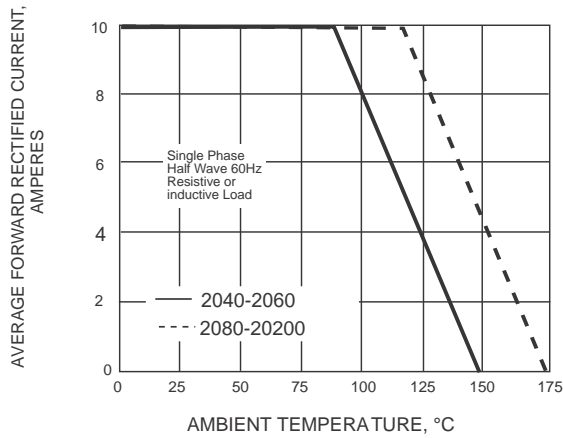

Fig.1 FORWARD CURRENT ERATING CURVE

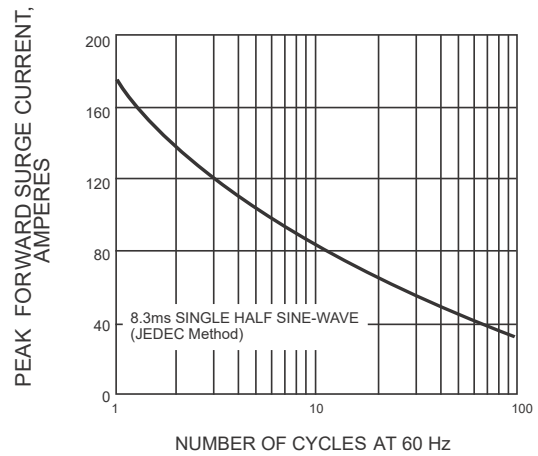

Fig.2 MAXIMUM NON-REPETITIVE SURGE CURRENT

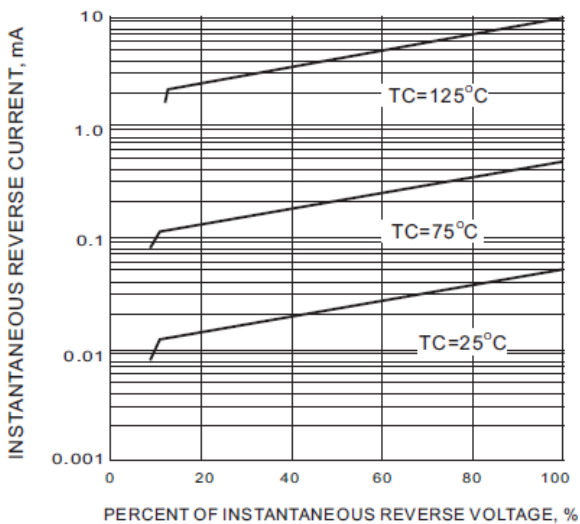

Fig.3 TYPICAL REVERSE CHARACTERISTIC

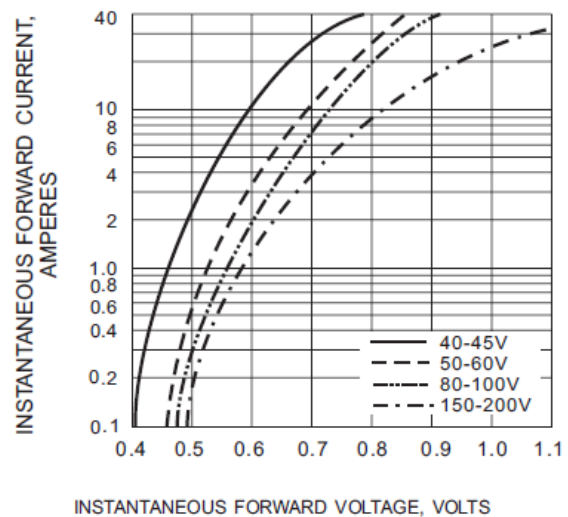
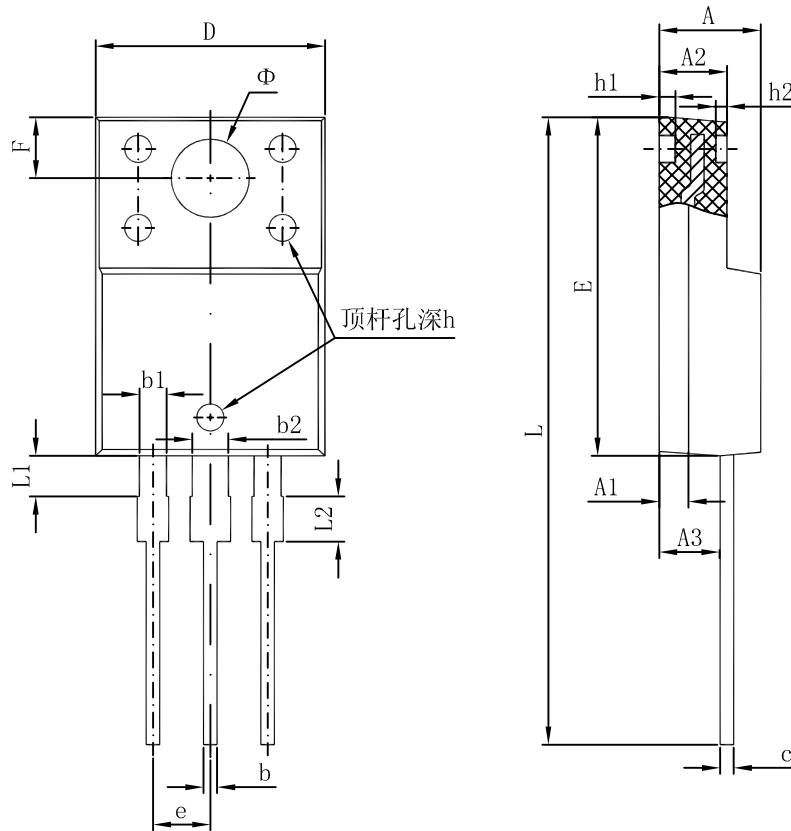

Fig.4 TYPICAL INSTANTANEOUS FORWARD CHARACTERISTIC



TO-220F(ITO-220AB-3) Package Information



Symbol	Dimensions In Millimeters		Dimensions In Inches	
	Min.	Max.	Min.	Max.
A	4.300	4.700	0.169	0.185
A1	1.300 REF.		0.051 REF.	
A2	2.800	3.200	0.110	0.126
A3	2.500	2.900	0.098	0.114
b	0.500	0.750	0.020	0.030
b1	1.100	1.350	0.043	0.053
b2	1.500	1.750	0.059	0.069
c	0.500	0.750	0.020	0.030
D	9.960	10.360	0.392	0.408
E	14.800	15.200	0.583	0.598
e	2.540 TYP.		0.100 TYP.	
F	2.700 REF.		0.106 REF.	
Φ	3.500 REF.		0.138 REF.	
h	0.000	0.300	0.000	0.012
h1	0.800 REF.		0.031 REF.	
h2	0.500 REF.		0.020 REF.	
L	28.000	28.400	1.102	1.118
L1	1.700	1.900	0.067	0.075
L2	1.900	2.100	0.075	0.083



Attention

- Any and all HUA XUAN YANG ELECTRONICS products described or contained herein do not have specifications that can handle applications that require extremely high levels of reliability, such as life-support systems, aircraft's control systems, or other applications whose failure can be reasonably expected to result in serious physical and/or material damage. Consult with your HUA XUAN YANG ELECTRONICS representative nearest you before using any HUA XUAN YANG ELECTRONICS products described or contained herein in such applications.
- HUA XUAN YANG ELECTRONICS assumes no responsibility for equipment failures that result from using products at values that exceed, even momentarily, rated values (such as maximum ratings, operating condition ranges, or other parameters) listed in products specifications of any and all HUA XUAN YANG ELECTRONICS products described or contained herein.
- Specifications of any and all HUA XUAN YANG ELECTRONICS products described or contained herein stipulate the performance, characteristics, and functions of the described products in the independent state, and are not guarantees of the performance, characteristics, and functions of the described products as mounted in the customer's products or equipment. To verify symptoms and states that cannot be evaluated in an independent device, the customer should always evaluate and test devices mounted in the customer's products or equipment.
- HUA XUAN YANG ELECTRONICS CO.,LTD. strives to supply high-quality high-reliability products. However, any and all semiconductor products fail with some probability. It is possible that these probabilistic failures could give rise to accidents or events that could endanger human lives, that could give rise to smoke or fire, or that could cause damage to other property. When designing equipment, adopt safety measures so that these kinds of accidents or events cannot occur. Such measures include but are not limited to protective circuits and error prevention circuits for safe design, redundant design, and structural design.
- In the event that any or all HUA XUAN YANG ELECTRONICS products(including technical data, services) described or contained herein are controlled under any of applicable local export control laws and regulations, such products must not be exported without obtaining the export license from the authorities concerned in accordance with the above law.
- No part of this publication may be reproduced or transmitted in any form or by any means, electronic or mechanical, including photocopying and recording, or any information storage or retrieval system, or otherwise, without the prior written permission of HUA XUAN YANG ELECTRONICS CO.,LTD.
- Information (including circuit diagrams and circuit parameters) herein is for example only ; it is not guaranteed for volume production. HUA XUAN YANG ELECTRONICS believes information herein is accurate and reliable, but no guarantees are made or implied regarding its use or any infringements of intellectual property rights or other rights of third parties.
- Any and all information described or contained herein are subject to change without notice due to product/technology improvement, etc. When designing equipment, refer to the "Delivery Specification" for the HUA XUAN YANG ELECTRONICS product that you intend to use.