

μPC834, 4064

Low Power Consumption J-FET Input Quad Operational Amplifier

R03DS0153EJ0100
Rev.1.00
2019.11.12

DESCRIPTION

The μPC834 and 4064 are low power consumption versions operational amplifier of μPC804 and 4084 series with the general-purpose J-FET input. This revolutionary J-FET input operational amplifier realizes low power consumption of I_{CC} 800 μA TYP. and low voltage operation from ± 2 V. Owing to its J-FET input, the input impedance is high. The AC characteristics are also greatly improved compared to the conventional low power consumption operational amplifier. Therefore, it is ideal for application circuits such as amplifier circuits and active filters in various battery-operated electronic devices.

Depending on the operating ambient temperature, μPC834 is suitable for communication application while μPC4064 is suitable for general-purpose usage.

Along with this series of lineup, the dual type op-amp μPC832 and 4062 with same circuit configuration are also available.

FEATURES

- Input Offset Voltage ±2 mV (TYP.)
- Input Bias Current 10 pA (TYP.)
- Slew Rate 3 V/μs (TYP.)
- Unity Gain Frequency 1 MHz (TYP.)
- Circuit Current 800 μA (TYP.)
- Operate from ±2 V
- Built-In Phase Compensation Circuit
- Built-In Output Short Circuit Protection
- Standard Quad Op-Amp terminal connection (pin compatible)

ORDERING INFORMATION

Ordering Name	Package
μPC834G2-A	14 pin plastic SOP (5.72 mm (225 mil))
μPC4064G2-A	14 pin plastic SOP (5.72 mm (225 mil))

EQUIVALENT CIRCUIT (1/4 Circuit)

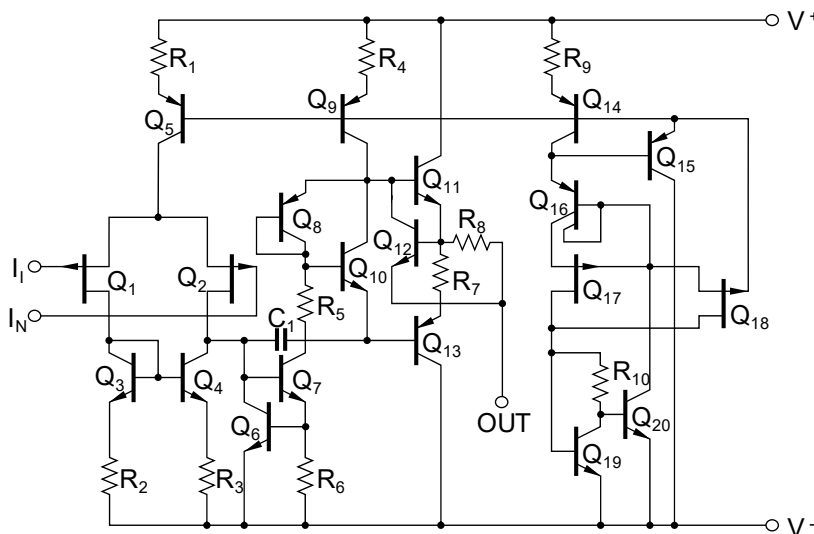

PIN CONFIGURATION (Top View)

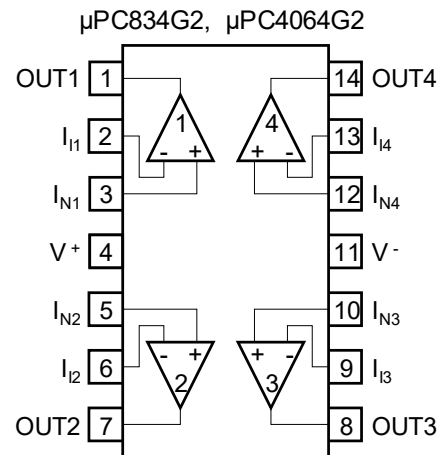

ABSOLUTE MAXIMUM RATINGS (T_A = 25 °C)

PARAMETER	SYMBOL	μPC834G2	μPC4064G2	UNIT
Supply Voltage ^{Note1}	V ⁺ to V ⁻	-0.3 to +36		V
Differential Input Voltage	V _{ID}	±30		V
Input Voltage ^{Note2}	V _I	V ⁻ -0.3 to V ⁺ +0.3		V
Output Applied Voltage ^{Note3}	V _O	V ⁻ -0.3 to V ⁺ +0.3		V
Total Power Dissipation ^{Note4}	P _T	550		mW
Output Short Circuit Duration ^{Note5}		indefinite		s
Operating Ambient Temperature	T _A	-40 to +85	-20 to +80	°C
Storage Temperature	T _{stg}	-55 to +125		°C

- [Note]
- Note that reverse connections of the power supply may damage the ICs.
 - The input terminal must be applied within the input voltage range to avoid deteriorating or damaging the device characteristic. Do not exceed the ratings including during transition state such as ON/OFF, etc. The Op-Amp input voltage must operate within the electrical characteristics range of input common-mode voltage.
 - The output terminal must be applied within the output voltage range to avoid deteriorating or damaging the device characteristic. Do not exceed the ratings including during transition state such as ON/OFF, etc. The Op-Amp output voltage must operate within the electrical characteristics range of maximum output voltage.
 - This is the value at T_A ≤ +25 °C. De-rate value at -5.5 mW/°C when T_A > 25 °C.
 - Please use the total loss and the de-rating value from Note 4.

RECOMMENDED OPERATING CONDITIONS

PARAMETER	SYMBOL	MIN.	TYP.	MAX.	UNIT
Power Supply Voltage	V [±]	±2		±16	V
Output Current (SOURCE)	I _{O SOURCE}			5	mA
Output Current (SINK)	I _{O SINK}			3.5	mA
Load Capacitance (When A _V = +1)	C _L			100	pF

ELECTRICAL CHARACTERISTICS (T_A = 25 °C, V[±] = ±15 V)

PARAMETER	SYMBOL	MIN.	TYP.	MAX.	UNIT	TEST CONDITION
Input Offset Voltage	V _{IO}		±2	±10	mV	R _S ≤ 50 Ω
Input Offset Current	I _{IO}		±5	±50	pA	
Input Bias Current ^{Note6}	I _B		10	100	pA	
Large Signal Voltage Gain	A _v	3000	9000			R _L ≥ 10 kΩ, V _O = ±10 V
Circuit Current ^{Note7}	I _{CC}		800	1000	μA	I _O = 0 A
Common Mode Rejection Ratio	CMR	70	90		dB	
Supply Voltage Rejection Ratio	SVR	70	90		dB	
Voltage Output Swing	V _{om}	±12	+14.0 -13.6		V	R _L ≥ 10 kΩ
Input Common-Mode Voltage Range	V _{ICM}	±12	+15 -13		V	
Slew Rate	SR		3		V/μs	A _v = 1
Unity Gain Frequency	f _{unity}		1		MHz	
Input Referred Noise Voltage Density	e _n		30		nV/ √Hz	R _S = 100 Ω, f = 1 kHz
Channel Separation			120		dB	
Input Offset Voltage	V _{IO}			±15	mV	R _S ≤ 50 Ω, T _A = -20 to +70 °C
Average V _{IO} Temperature Drift	ΔV _{IO} /ΔT		±10		μV/°C	T _A = -20 to +70 °C
Input Offset Current	I _{IO}			±2	nA	T _A = -20 to +70 °C
Input Bias Current ^{Note6}	I _B			3.5	nA	T _A = -20 to +70 °C

- [Note] 6. The direction of the input bias current is the same direction that flows into the IC because the first stage is comprised of Pch J-FET. When T_J = 25 °C or higher, it increases exponentially with increase in temperature (please see I_B vs. T_A characteristics). During measurement, please kindly take care of T_J ≅ T_A
7. It is the current that flows into the internal circuit. This current flow is irrespective of the channel usage.

ELECTRICAL CHARACTERISTICS CURVE (T_A = 25 °C, TYP.) (REFERENCE VALUE)

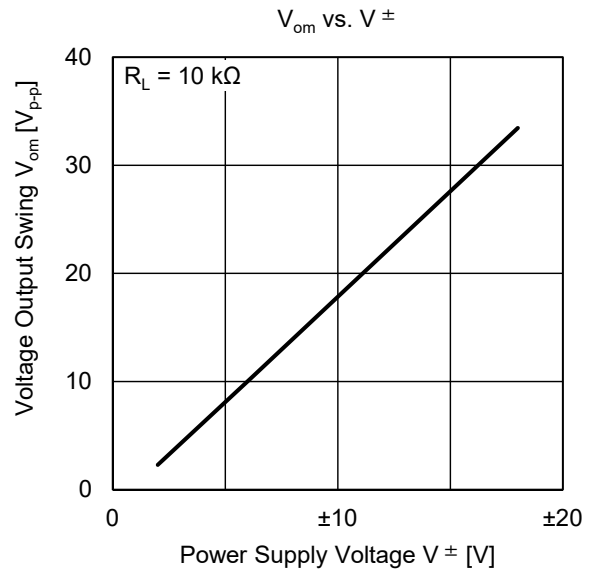
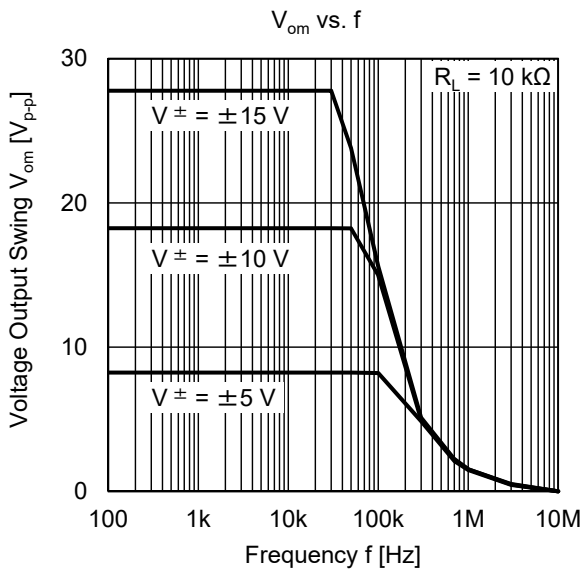
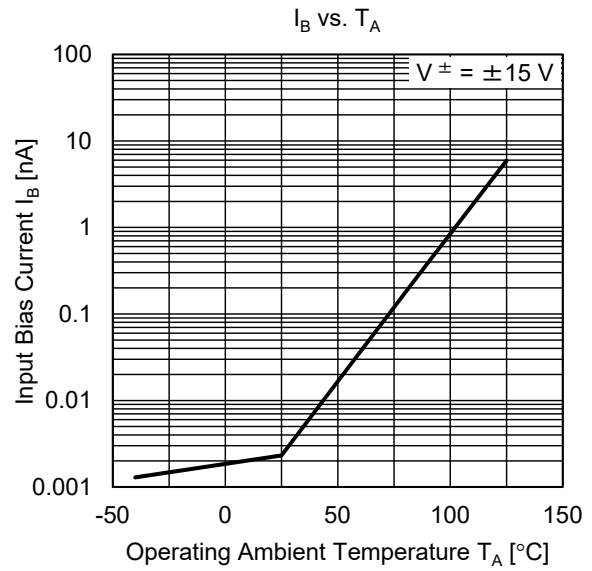
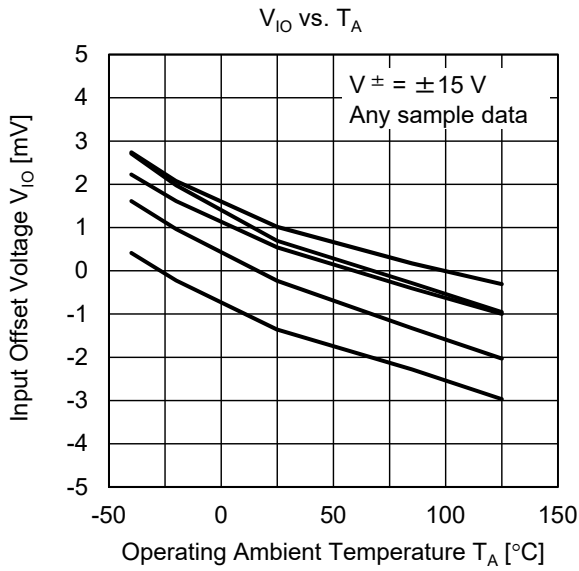
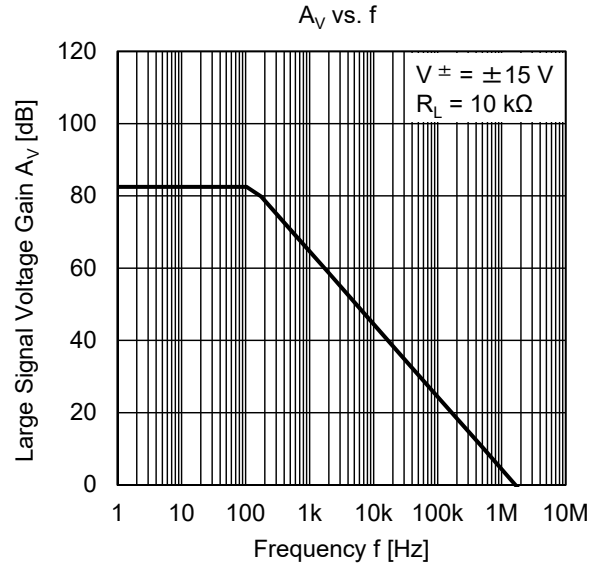
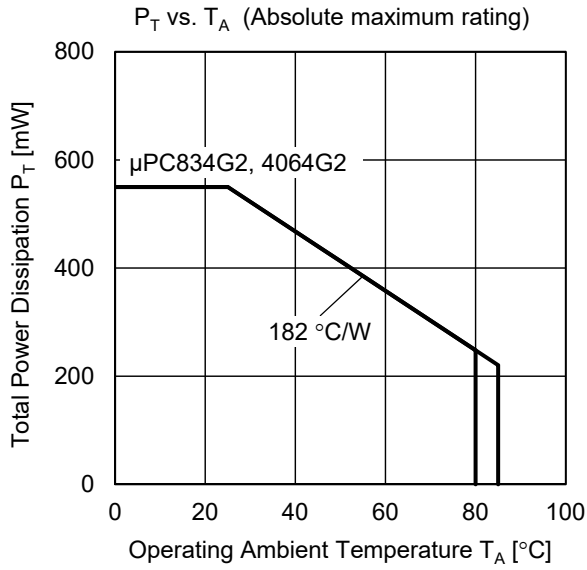

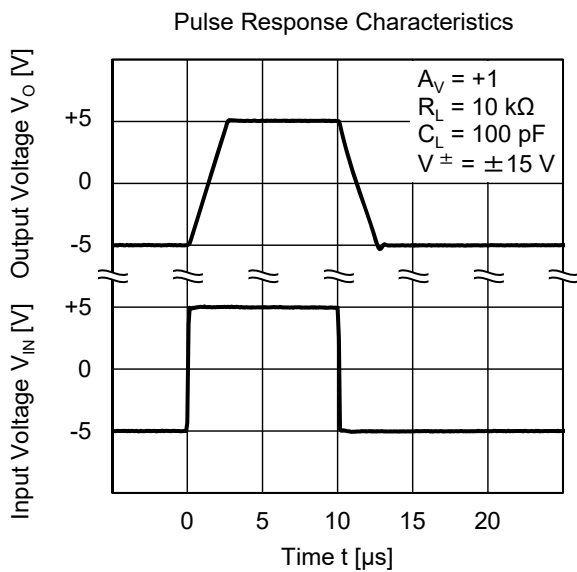
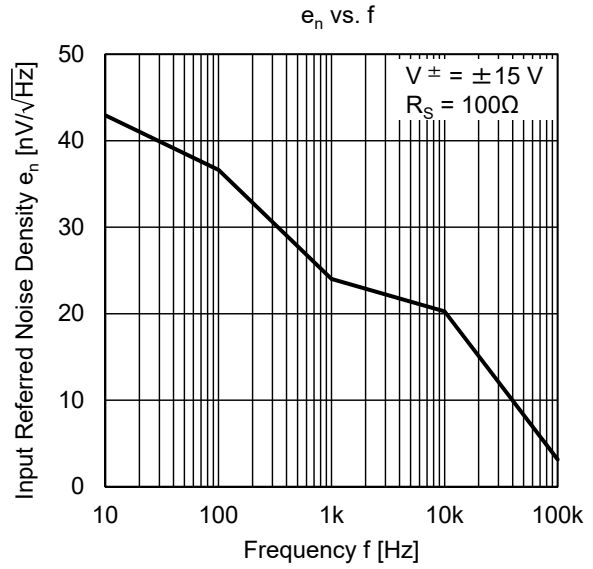
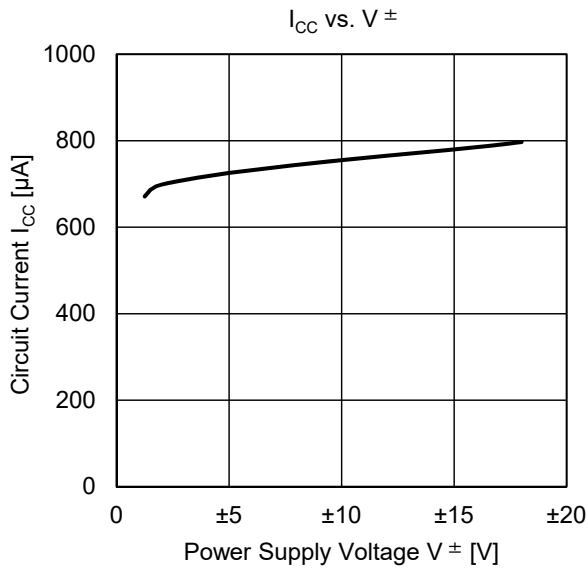
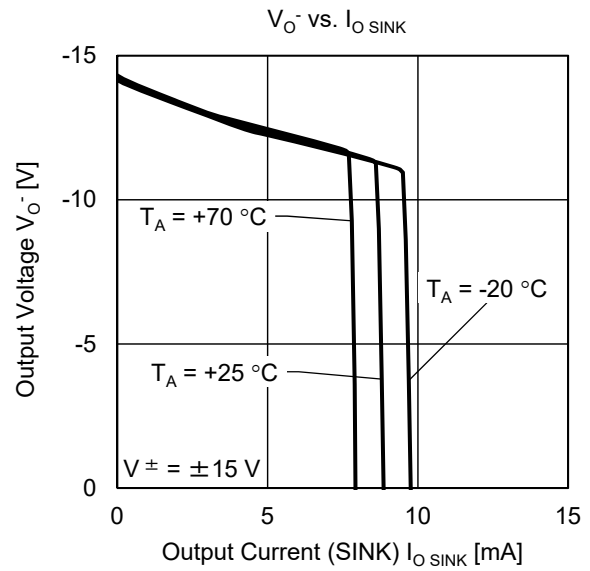
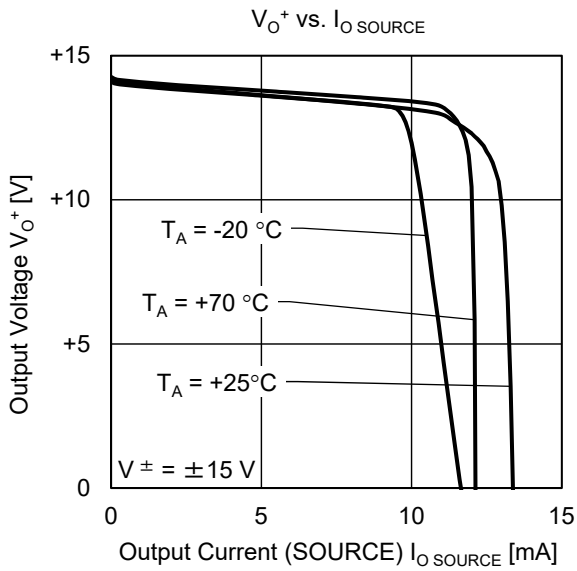

USE WITH PRECAUTIONS

- Managing unused circuits
If there is an unused circuit, the following connection is recommended.

Example of handling unused circuit

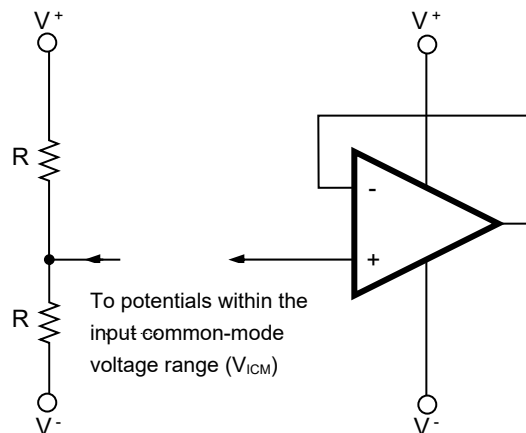

Note in this example, an intermediate voltage of V^+ and V^- is applied.

- Power Supply (Dual Power Supply / Single Power Supply)**

The op-amp operates when a predetermined voltage is applied between V^+ to V^- . Therefore, while it operates from a single power supply ($V^- = \text{GND}$), it is not possible to operate the input and output near GND. So please be careful of the common-mode input voltage range and maximum output voltage.

- Ratings of input/output pin voltage**

When the voltage of input/output pin exceeds the absolute maximum rating, the parasitic diode within the IC may conduct, causing characteristics degradation or damage. In addition, if the voltage of input pin is lower than V^- , or the voltage of output pin exceeds the power supply voltage, it is recommended to make a clamping circuit using a diode with low forward voltage (e.g.: Schottky diode) as protection.

- Input common-mode voltage range**

When the supply voltage does not meet the condition of electrical characteristics, the input common-mode voltage range is as follows.

$$V_{ICM} \text{ (TYP.): } V^- + 2 \text{ to } V^+ \text{ [V] (} T_A = 25 \text{ }^\circ\text{C)}$$

During designing, do include some margin by considering characteristic variations, temperature characteristics etc.

- Maximum Output Voltage**

When the supply voltage does not meet the condition of electrical characteristics, the TYP. value range of the maximum output voltage is as follows:

$$V_{om}^+ \text{ (TYP.): } V^+ - 1 \text{ [V] (} T_A = 25 \text{ }^\circ\text{C)}, V_{om}^- \text{ (TYP.): } V^- + 1.4 \text{ [V] (} T_A = 25 \text{ }^\circ\text{C)}$$

During designing, do include some margin by considering characteristic variations, temperature characteristics and so on. In addition, also note that the output voltage range (V_{om}^+ to V_{om}^-) will become narrow when the output current increases.

- Handling of ICs**

When stress is added to the ICs due to warpage or bending of a board, the characteristic may fluctuate due to piezoelectric (piezo) effect. Therefore, pay attention to warpage or bending of a board.

PACKAGE DRAWINGS

14-PIN PLASTIC SOP

JEITA Package code	RENESAS code	Previous code	MASS (TYP.) [g]
P-SOP14-0225-1.27	PRSP0014DI-A	P14GR-50-225B	0.14

Unit: mm

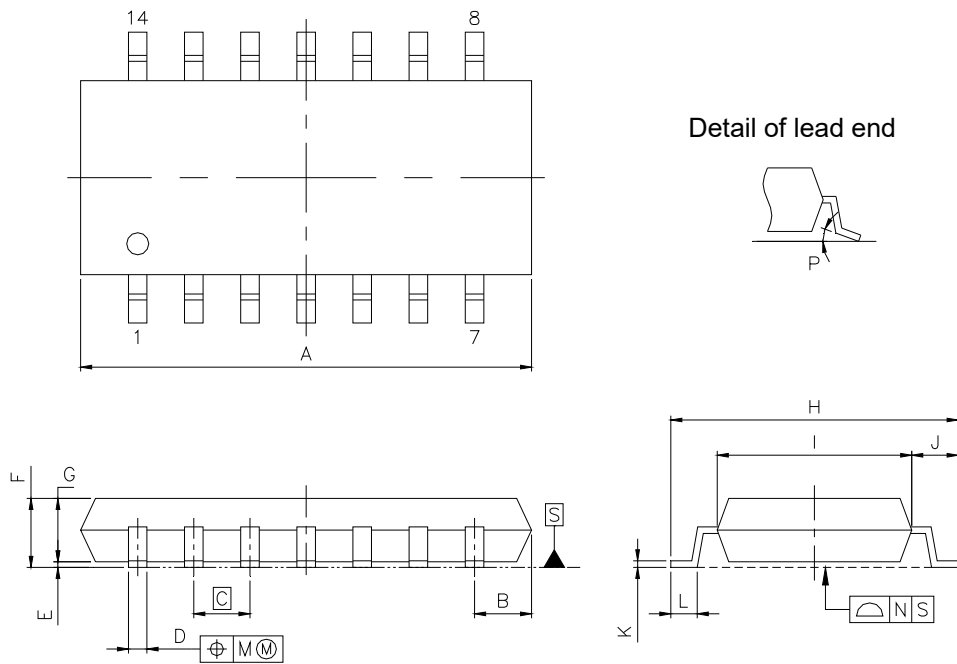
**NOTE**

Each lead centerline is located within 0.12 mm of its true position (T.P.) at maximum material condition.

ITEM	MILLIMETERS
A	10.2 ±0.26
B	1.42 MAX
C	1.27 (T.P.)
D	0.42 ^{+0.08} _{-0.07}
E	0.1 ±0.1
F	1.59 ^{+0.21} _{-0.2}
G	1.49
H	6.5 ±0.2
I	4.4 ±0.1
J	1.1 ±0.16
K	0.17 ^{+0.08} _{-0.07}
L	0.6 ±0.2
M	0.1
N	0.10
P	3° ^{+7°} _{-3°}

Notice

- Descriptions of circuits, software and other related information in this document are provided only to illustrate the operation of semiconductor products and application examples. You are fully responsible for the incorporation of any other use of the circuits, software, and information in the design of your product or system. Renesas Electronics disclaims any and all liability for any losses and damages incurred by you or third parties arising from the use of these circuits, software, or information.
- Renesas Electronics hereby expressly disclaims any warranties against and liability for infringement or any other claims involving patents, copyrights, or other intellectual property rights of third parties, by or arising from the use of Renesas Electronics products or technical information described in this document, including but not limited to, the product data, drawings, charts, programs, algorithms, and application examples.
- No license, express, implied or otherwise, is granted hereby under any patents, copyrights or other intellectual property rights of Renesas Electronics or others.
- You shall not alter, modify, copy, or reverse engineer any Renesas Electronics product, whether in whole or in part. Renesas Electronics disclaims any and all liability for any losses or damages incurred by you or third parties arising from such alteration, modification, copying or reverse engineering.
- Renesas Electronics products are classified according to the following two quality grades: "Standard" and "High Quality". The intended applications for each Renesas Electronics product depends on the product's quality grade, as indicated below.
"Standard": Computers; office equipment; communications equipment; test and measurement equipment; audio and visual equipment; home electronic appliances; machine tools; personal electronic equipment; industrial robots; etc.
"High Quality": Transportation equipment (automobiles, trains, ships, etc.); traffic control (traffic lights); large-scale communication equipment; key financial terminal systems; safety control equipment; etc.
Unless expressly designated as a high reliability product or a product for harsh environments in a Renesas Electronics data sheet or other Renesas Electronics document, Renesas Electronics products are not intended or authorized for use in products or systems that may pose a direct threat to human life or bodily injury (artificial life support devices or systems; surgical implantations; etc.), or may cause serious property damage (space system; undersea repeaters; nuclear power control systems; aircraft control systems; key plant systems; military equipment; etc.). Renesas Electronics disclaims any and all liability for any damages or losses incurred by you or any third parties arising from the use of any Renesas Electronics product that is inconsistent with any Renesas Electronics data sheet, user's manual or other Renesas Electronics document.
- When using Renesas Electronics products, refer to the latest product information (data sheets, user's manuals, application notes, "General Notes for Handling and Using Semiconductor Devices" in the reliability handbook, etc.), and ensure that the usage conditions are within the ranges specified by Renesas Electronics with respect to maximum ratings, operating power supply voltage range, heat dissipation characteristics, installation, etc. Renesas Electronics disclaims any and all liability for any malfunctions, failure or accident arising out of the use of Renesas Electronics products outside of such specified ranges.
- Although Renesas Electronics endeavors to improve the quality and reliability of Renesas Electronics products, semiconductor products have specific characteristics, such as the occurrence of failure at a certain rate and malfunctions under certain use conditions. Unless designated as a high reliability product or a product for harsh environments in a Renesas Electronics data sheet or other Renesas Electronics document, Renesas Electronics products are not subject to radiation resistance design. You are responsible for implementing safety measures to guard against the possibility of bodily injury, injury or damage caused by fire, and/or danger to the public in the event of a failure or malfunction of Renesas Electronics products, such as safety design for hardware and software, including but not limited to redundancy, fire control and malfunction prevention, appropriate treatment for aging degradation or any other appropriate measures. Because the evaluation of microcomputer software alone is very difficult and impractical, you are responsible for evaluating the safety of the final products or systems manufactured by you.
- Please contact a Renesas Electronics sales office for details as to environmental matters such as the environmental compatibility of each Renesas Electronics product. You are responsible for carefully and sufficiently investigating applicable laws and regulations that regulate the inclusion or use of controlled substances, including without limitation, the EU RoHS Directive, and using Renesas Electronics products in compliance with all these applicable laws and regulations. Renesas Electronics disclaims any and all liability for damages or losses occurring as a result of your noncompliance with applicable laws and regulations.
- Renesas Electronics products and technologies shall not be used for or incorporated into any products or systems whose manufacture, use, or sale is prohibited under any applicable domestic or foreign laws or regulations. You shall comply with any applicable export control laws and regulations promulgated and administered by the governments of any countries asserting jurisdiction over the parties or transactions.
- It is the responsibility of the buyer or distributor of Renesas Electronics products, or any other party who distributes, disposes of, or otherwise sells or transfers the product to a third party, to notify such third party in advance of the contents and conditions set forth in this document.
- This document shall not be reprinted, reproduced or duplicated in any form, in whole or in part, without prior written consent of Renesas Electronics.
- Please contact a Renesas Electronics sales office if you have any questions regarding the information contained in this document or Renesas Electronics products.
(Note 1) "Renesas Electronics" as used in this document means Renesas Electronics Corporation and also includes its directly or indirectly controlled subsidiaries.
(Note 2) "Renesas Electronics product(s)" means any product developed or manufactured by or for Renesas Electronics.

以下“注意事项”为从英语原稿翻译的中文译文，仅作为参考译文，英文版的“Notice”具有正式效力。

注意事项

- 本文中记载的关于电路、软件和其他相关信息仅用于说明半导体产品的操作和应用实例。用户如在产品或系统设计中应用本文档中的电路、软件和相关信息或将此等内容用于其他目的时，请自行负责。对于用户或第三方因使用上述电路、软件或信息而遭受的任何损失和损害，瑞萨电子不承担任何责任。
- 瑞萨电子在此明确声明，对于因使用瑞萨电子产品或本文档中所述技术信息（包括但不限于产品数据、图、表、程序、算法、应用实例）而造成的与第三方专利、版权或其他知识产权相关的侵权或任何其他索赔，瑞萨电子不作任何保证并不承担责任。
- 本文中记载的内容不应视为对瑞萨电子或其他人所有的专利、版权或其他知识产权作出任何明示、默示或其它方式的许可及授权。
- 用户不得对瑞萨电子的任何产品进行全部或部分更改、修改、复制或反向工程。对于用户或第三方因上述更改、修改、复制或反向工程的行为而遭受的任何损失或损害，瑞萨电子不承担任何责任。
- 瑞萨电子产品根据其质量等级分为两个等级：“标准等级”和“高质量等级”。每种瑞萨电子产品的预期用途均取决于产品的质量等级，如下所示：
标准等级：计算机、办公设备、通讯设备、测试和测量设备、视听设备、家用电器、机械工具、个人电子设备、工业机器人等。
高质量等级：运输设备（汽车、火车、轮船等）、交通控制系统（交通信号灯）、大型通讯设备、关键金融终端系统、安全控制设备等。
除非瑞萨电子产品数据表或其他瑞萨电子文档中明确指定为高可靠性产品或用于恶劣环境的产品，否则瑞萨电子产品不能用于、亦未授权用于可能对人类生命造成直接威胁的产品或系统及可能造成人身伤害的产品或系统（人工生命维持装置或系统、植入体内的装置等）中，或者可能造成重大财产损失的产品或系统（太空系统、海底增音机、核能控制系统、飞机控制系统、关键装置系统、军用设备等）中。对于用户或任何第三方因使用不符合瑞萨电子产品数据表、使用说明书或其他瑞萨电子文档的瑞萨电子产品而遭受的任何损害或损失，瑞萨电子不承担任何责任。
- 使用瑞萨电子产品时，请参阅最新产品信息（数据表、使用说明书、应用指南、可靠性手册中的“半导体元件处理和使用一般注意事项”等），并确保使用条件在瑞萨电子指定的最大额定值、电源工作电压范围、散热特性、安装条件等范围内使用。对于在上述指定范围之外使用瑞萨电子产品而产生的任何故障、失效或事故，瑞萨电子不承担任何责任。
- 虽然瑞萨电子一直致力于提高瑞萨电子产品的质量和可靠性，但是，半导体产品有其自身的具体特性，如一定的故障发生率以及在某些使用条件下会发生故障等。除非瑞萨电子产品数据表或其他瑞萨电子文档中指定为高可靠性产品或用于恶劣环境的产品，否则瑞萨电子产品未进行防辐射设计。用户负责执行安全保护措施，以避免因瑞萨电子产品失效或发生故障而造成身体伤害、火灾导致伤害或损害和/或其他对公众构成危险事故。例如进行软硬件安全设计（包括但不限于冗余设计、防火控制以及故障预防等）、适当的老化处理或其他适当的措施等。由于对微机电软件单独进行评估非常困难且并不实际，所以请用户自行负责对最终产品或系统进行安全评估。
- 关于环境保护方面的详细内容，例如每种瑞萨电子产品的环境兼容性等，请与瑞萨电子的营业部门联系。用户负责仔细并充分查阅对管制物质的使用或含量进行管理的所有适用法律法规（包括但不限于《欧盟RoHS指令》），并在使用瑞萨电子产品时遵守所有适用法律法规。对于因用户未遵守相应适用法律法规而导致的损害或损失，瑞萨电子不承担任何责任。
- 不可将瑞萨电子产品和技术用于或者嵌入日本国内或海外相应的法律法规所禁止生产、使用或销售的任何产品或系统中。也不可将其用于(1)与大规模杀伤性武器（例如核武器、化学武器、生物武器或运送这些武器的导弹，包括无人飞行器(UAV)）的开发、设计、制造、使用、存储等相关的任何目的；(2)与常规武器的开发、设计、制造或使用相关的任何目的；(3)扰乱国际和平与安全的任何其他目的，并且不可向任何第三方销售、出口、租赁、转让、或让与瑞萨电子产品或技术，无论直接或间接知悉或者有理由知悉该第三方或任何其他方将从从事上述活动。用户必须遵守对各方或交易行司法管辖权的任意国家/地区政府所公布和管理的任何适用出口管制法律法规。
- 瑞萨电子产品的买方或分销商，或者分销、处置产品、或以其他方式向第三方出售或转让产品的任何其他方有责任事先向所述第三方通知本文档规定的内容和条件。
- 在事先未得到瑞萨电子书面认可的情况下，不得以何形式部分或全部再版、转载或复制本文档。
- 如果对本文档所记载的信息或瑞萨电子产品有任何疑问，请向瑞萨电子的营业部门咨询。
(注1) 瑞萨电子：在本文中指瑞萨电子株式会社及其控股子公司。
(注2) 瑞萨电子产品：指瑞萨电子开发或生产的任何产品。

(Rev.4.0-1 November 2017)



Renesas Electronics Corporation

<http://www.renesas.com>

SALES OFFICES

Refer to "<http://www.renesas.com/>" for the latest and detailed information.

Renesas Electronics Corporation
TOYOSU FORESIA, 3-2-24 Toyosu, Koto-ku, Tokyo 135-0061, Japan

Renesas Electronics America Inc.
1001 Murphy Ranch Road, Milpitas, CA 95035, U.S.A.
Tel: +1-408-432-8888, Fax: +1-408-434-5351

Renesas Electronics Canada Limited
9251 Yonge Street, Suite 8309 Richmond Hill, Ontario Canada L4C 9T3
Tel: +1-905-237-2004

Renesas Electronics Europe GmbH
Arcadisstrasse 10, 40472 Düsseldorf, Germany
Tel: +49-211-6503-0, Fax: +49-211-6503-1327

Renesas Electronics (China) Co., Ltd.
Room 101-101, Floor 1, Building 7, Yard No. 7, 8th Street, Shanghai, Haidian District, Beijing 100085, China
Tel: +86-10-8235-1155, Fax: +86-10-8235-7679

Renesas Electronics (Shanghai) Co., Ltd.
Unit 301, Tower A, Central Towers, 555 Lango Road, Putuo District, Shanghai 200333, China
Tel: +86-21-2226-0695, Fax: +86-21-2226-0599

Renesas Electronics Hong Kong Limited
Unit 1601-1611, 16/F., Tower 2, Grand Century Place, 193 Prince Edward Road West, Mongkok, Kowloon, Hong Kong
Tel: +852-2265-6688, Fax: +852-2886-9022

Renesas Electronics Taiwan Co., Ltd.
13F, No. 363, Fu Shing North Road, Taipei 10543, Taiwan
Tel: +886-2-8175-9600, Fax: +886-2-8175-9670

Renesas Electronics Singapore Pte. Ltd.
80 Bendemeer Road, Unit #03-02 Hyflux Innovation Centre, Singapore 339949
Tel: +65-6213-0200, Fax: +65-6213-0300

Renesas Electronics Malaysia Sdn.Bhd.
Unit No 3A-1 Level 3A Tower 8 UOA Business Park, No 1 Jalan Pengaturcara U1/51A, Seksyen U1, 40150 Shah Alam, Selangor, Malaysia
Tel: +60-3-5022-1298, Fax: +60-3-5022-1290

Renesas Electronics India Pvt. Ltd.
No.777C, 100 Feet Road, HAL 2nd Stage, Indiranagar, Bangalore 560 038, India
Tel: +91-80-67208700

Renesas Electronics Korea Co., Ltd.
17F, KAMCO Yangjae Tower, 262, Gangnam-daero, Gangnam-gu, Seoul, 06265 Korea
Tel: +82-2-558-3737, Fax: +82-2-558-9338

© 2019 Renesas Electronics Corporation. All rights reserved.

Colophon 8.0