

超级电容器产品规格书

SUPERCAPACITOR PRODUCT SPECIFICATION

产品类型 (Product Type) : 圆柱系列 Cylindrical series

产品型号 (Product Model) : FH2R7L105M-N0813

更新日期 (Updated Date) : 2021-07-15

| Prepared 编制 | Checked 审核 | Approved 批准 |
|------------------|--------------|------------------|
| 陈春辉 Chunhui Chen | 农剑 Jian Nong | 朱归胜 Guisheng Zhu |

广东风华高新科技股份有限公司

Guangdong Fenghua Advanced Technology(Holding) Co.,Ltd

地址：广东省肇庆市风华路 18 号风华电子工业城

Address: Fenghua electronics industry city, No. 18 fenghua road, zhaqing city, guangdong province

电话 (Phone) : 0758-6923076

传真 (Fax) : 0758-2865223

网址 (The url) : <http://www.china-fenghua.com>

FH2R7L105M-N0813

产品规格书 Product specification

➤ 产品特点 Features

内阻低，功率密度高； Low internal resistance and high power density;

自放电率小，72 小时自放电<20%；

Self-discharge rate is small, 72 hours self-discharge <20%;

优异的循环寿命，库仑效率达 95%以上；

Excellent cycle life, the coulomb efficiency is more than 95%;

工作温度范围宽；

Wide operating temperature range;

绿色环保，满足 RoHs 要求；

Green, meet RoHs requirements;

➤ 应用 Applications

智能仪表，行车记录仪，照明灯具；

Intelligent instrument, automobile data recorder, illumination lamp;

税控收款机、数码相机、电动工具；

Fiscal cash register, digital camera, power tools;

无线节能鼠标、无线手写板、SSD 固态硬盘。

Wireless energy saving mouse, wireless handwriting board, SSD solid state drive.

➤ 型号命名规则 Part Number System

| F H | | 2 R 7 | | L | | 1 0 5 | | M | | N | | 0 8 1 3 | |
|---------------------|--------------------------------------|------------------------------|------------------------|-----------------|-------|------------------------------|-----------|-----------------------------------------|------------------------|---------------------------|----------|-------------------------------|--|
| 品牌代码 Brand FH | | 额定电压 The rated voltage | | 结构 Structure | | 额定容量 Rated Capacitance | | 容量偏差 Permitting capacitance error | | 特性 Series | | 单体尺寸 φD*L/mm Dimensions | |
| 2R7 | 2.7V | L | 引针式 Radial Type | 104 | 0.1F | X | -10%~+30% | N | 常规 Normal | 0612 | 6.3*12.5 | | |
| | | | | 224 | 0.22F | | | | | 0813 | 8*13 | | |
| | | | | 334 | 0.33F | | | | | 1020 | 10*20 | | |
| | | | | 474 | 0.47F | | | | | 1225 | 12.5*25 | | |
| | | | | 504 | 0.5F | | | | | 1313 | 13*13 | | |
| | | S | 牛角式 Snap In type | 105 | 1.0F | V | -10%~+10% | | H | 高温 High Temperature | 1625 | 16*25 | |
| | | | | 155 | 1.5F | | | | | | 1840 | 18*40 | |
| | | | | 205 | 2.0F | | | | | | 2245 | 22*45 | |
| | | | | 305 | 3.0F | | | | | | 3564 | 35*64 | |
| | | | | 505 | 5.0F | | | | | | | | |
| F | 四端头可 焊式 Four tab Solderable | W | 螺柱式 Stud type | 705 | 7.0F | M | ±20% | L | 低内阻 Low ESR | 1313 | 13*13 | | |
| | | | | 106 | 10F | | | | | 1625 | 16*25 | | |
| | | | | 206 | 20F | | | | | 1840 | 18*40 | | |
| | | | | 256 | 25F | | | | | 2245 | 22*45 | | |
| | | | | 356 | 35F | | | | | 3564 | 35*64 | | |
| | | P | 焊接螺柱 Weld Stud | 206 | 20F | T | -20%~+80% | V | 高电压 High Voltage | 1625 | 16*25 | | |
| | | | | 256 | 25F | | | | | 1840 | 18*40 | | |
| | | | | 356 | 35F | | | | | 2245 | 22*45 | | |
| | | | | 506 | 50F | | | | | 3564 | 35*64 | | |
| | | | | 308 | 3000F | | | | | | | | |
| K | 螺纹式 Screw type | C | 纽扣式 Coin type | | | | | | | | | | |
| | | V | 纽扣式 Coin type | | | | | | | | | | |
| | | H | 纽扣式 Coin type | | | | | | | | | | |
| Z | 组合式 Combined type | | | | | | | | | | | | |
| M | 锂离子电 容LIC | | | | | | | | | | | | |

➤ 产品性能 Specifications

| 项目 project | | FH2R7L105M-N0813 | | 测试方法 The test conditions |
|--------------------------------------------------------|--------------|--------------------------------------------------------------------|--------------------------------------------------------------------|--------------------------------------------------------------------------------------------|
| 工作温度范围 Category temperature range | | -40℃~+70℃ | | |
| 额定工作电压 Rated operating voltage | | 2.7V DC | | |
| 容量 Capacitance | | 1.0F | | I=8*CU _R (mA) |
| 容量允许偏差 Permitting capacitance error | | -20%~+20% | | |
| 参考内阻 DC@25℃ Internal resistance reference value(DC) | | / | | |
| 温度特性 Characteristics in different temperature | 容量ΔC | Step 2 | 小于等于 30%初始规定值 Less than or equal to 30% of the initial value | Step 1: +25℃±2℃ Step 2: -40℃±2℃ Step 3: +70℃±2℃ Step 4: +25℃±2℃ |
| | ESR | | 小于等于初始规定值 400% Less than or equal to 400% of the initial value | |
| | 容量ΔC | Step 3 | 小于等于 30%初始规定值 Less than or equal to 30% of the initial value | |
| | ESR | | 小于等于初始规定值 Less than or equal to the initial value | |
| | 漏 电 流 L.C | | 小于等于初始规定值 4 倍 Less than or equal to 4 times the initial value | |
| | 容量ΔC | Step 4 | 满足初始规定值 20%范围内 Satisfies the range of 20% of the initial rating | |
| | ESR | | 满足初始规定值 Satisfies the initial value | |
| | 漏 电 流 L.C | | 满足初始规定值 Satisfies the initial value | |
| 耐久性 Endurance | 容量ΔC | 满足初始规定值 30%范围内 Satisfies the range of 30% of the initial rating | | 施加电压 Applied voltage: 2.7V 温度 Temperature: +70℃±2℃ 时间 Time: 1000h |
| | ESR | 小于等于初始规定值 4 倍 Less than or equal to 4 times the initial value | | |
| | 漏电流 L.C | 小于等于初始测量值 Less than or equal to the initial measurement | | |
| | 外观 | 无漏液或机械损伤 No leakage or mechanical damage | | |
| 循环寿命 Cycle life | 容量ΔC | 满足初始规定值 30%范围内 Satisfies the range of 30% of the initial rating | | 施加电压 Applied voltage: 2.7V 温度 Temperature: +25℃±2℃ 次数 Cycles: 500000 次 |
| | ESR | 小于等于初始规定值 4 倍 Less than or equal to 4 times the initial value | | |
| 湿热特性 Humidity Characteristics | 容量ΔC | 满足初始规定值 30%范围内 Satisfies the range of 30% of the initial rating | | 温度 Temperature: +40℃±2℃ 相对湿度 Relative humidity : 90~95%RH 测试时间 Test time: 240h |
| | ESR | 小于等于初始规定值 2 倍 Less than or equal to 2 times the initial value | | |
| | 漏电流 L.C | 小于等于初始规定值 4 倍 Less than or equal to 4 times the initial value | | |
| | 外观 | 无漏液或机械损伤 No leakage or mechanical damage | | |

| 项目 project | | FH2R7L105M-N0813 | 测试方法 The test conditions |
|------------------------------------------------------------------------------------------|------------------|-------------------------------------------------------------------------------------|----------------------------------------------------------------------------------------------------------------------------------------------------------------------------------------------------------------------------------------------------------------------------------------------------------------------------------------------------------------|
| 高低温循环特性 Temperature cycle | 容量 C | 满足初始规定值 Satisfies the initial value | 温度循环: $-40^{\circ}\text{C} \pm 2^{\circ}\text{C} \rightarrow$ 常温 \rightarrow $+70^{\circ}\text{C} \pm 2^{\circ}\text{C} \rightarrow$ 常温 Temperature cycle: $-40^{\circ}\text{C} \pm 2^{\circ}\text{C} \rightarrow$ normal temperature $\rightarrow +70^{\circ}\text{C} \pm 2^{\circ}\text{C}$ \rightarrow normal temperature 循环次数 Cycles: 5 |
| | ESR | | |
| | 漏电流 L.C | | |
| | 外观 appearance | 无机械损伤或漏液 No mechanical damage or leakage | |
| 存放寿命特性 Shelf life | 容量 C | 满足初始规定值 20%范围内 Satisfies the range of 20% of the initial rating | 施加电压 Applied voltage: 0V 温度 Temperature: $+70^{\circ}\text{C} \pm 2^{\circ}\text{C}$ 时间 Time: 1000h |
| | ESR | 小于等于初始规定值 3 倍 Less than or equal to 3 times the initial value | |
| | 漏电流 L.C | 小于等于初始测量值 Less than or equal to the initial | |
| | 外观 appearance | 无漏液或机械损伤 No mechanical damage or leakage | |
| 自放电特性 (电压保持特性) Self discharge characteristics (voltage holding characteristics) | | 正负极间电压大于等于 2.3V Voltage between positive and negative poles $\geq 2.3\text{V}$ | 充电过程: 常温, 无负载, 额定电压充电 24h Charging process: normal temperature, no load, rated voltage charge 24h 放置过程: 温度小于等于 25°C , 相对湿度小于 60%RH, 开路放置 24h Placement process: temperature less than or equal to 25°C , relative humidity less than 60% RH, open 24 h |
| 引出端强度 Lead strength | | 引出端无损坏 No damage to the outlet | |
| 可焊性 Solder ability | | 超过 3/4 端子表面被锡层覆盖 More than 3/4 of the terminal surface is covered by a tin layer | |

➤ **标准产品外形尺寸图 shape of standard product**

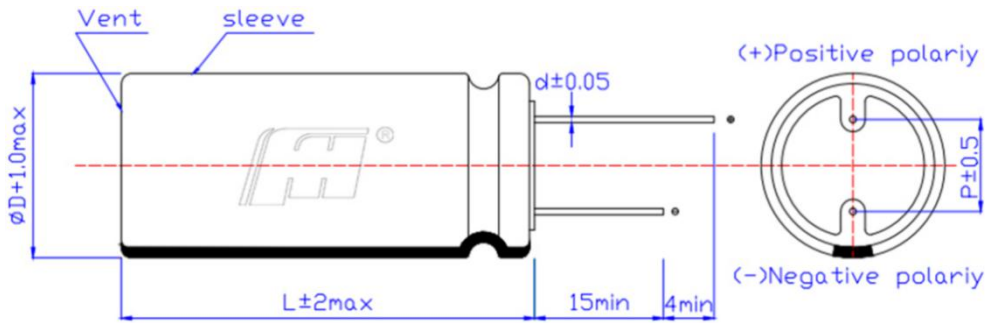

实际尺寸及公差以参数表为准。

The actual size and tolerance shall be subject to the parameter table.

➤ **标准产品规定值及尺寸 Spec. value of standard product and dimensions**

| 型号 Part Number | 额定电压 Rated Voltage (V) | 额定电容 Rated Capacitance (F) | 最大内阻 MAX ESR DC 25°C (mΩ) | 额定电流 ¹ Nominal Current (25°C, A) | 最大峰值电流 ² Maximum Peak Current (25°C < 1s, A) | 漏电流 Leakage Current (25°C 72h, mA) | 产品尺寸 Size/ mm | | |
|-------------------|------------------------------|----------------------------------|------------------------------------|---------------------------------------------------|---------------------------------------------------------------|------------------------------------------|------------------|-----------|------------|
| | | | | | | | D*L ±1.0 | P ±0.5 | d ±0.05 |
| FH2R7L105M-N0813 | 2.7 | 1.0 | 350 | 0.25 | 1.0 | 0.008 | 8*13 | 3.5 | 0.6 |

NOTE:

1. 额定电流: 5s 从额定电压 U_R 放电至 $1/2U_R$ 的电流值。
Nominal Current: Is the current taking 5 sec. to discharge from U_R to $1/2U_R$.
2. 最大峰值电流: 1s 从额定电压 U_R 放电至 $1/2U_R$ 的电流值。
Maximum Peak Current: Is the current taking 1 sec. to discharge from U_R to $1/2U_R$.

➤ **包装规格 Packing Specification**

| 型号 Part Number | 数量 Quantity (PCS) | | | 尺寸 Dimension (L×W×H)mm | |
|-------------------|----------------------|-------------|-------------|---------------------------|-------------|
| | 塑料袋 Plastic Bag | 内箱 Inner | 外箱 Outer | 内箱 Inner | 外箱 Outer |
| FH2R7L105M-N0813 | 1500 | 1500 | 1500*4=6000 | 240*182*94 | 395*255*208 |

包装规格可按需求更改, 下单前请与我司联系确定。

Packaging specifications can be changed as needed, please contact us before you place your order.

➤ 超级电容器测试方法 Measuring Method

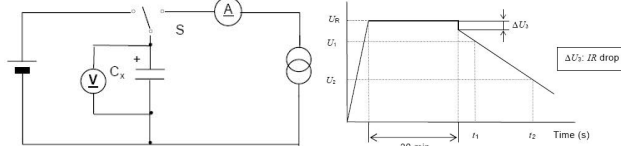
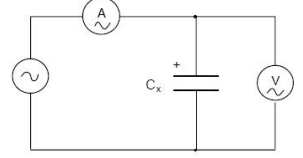
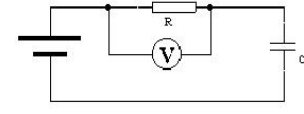
| | |
|--------------------------------|------------------------------------------------------------------------------------------------------------------------------------------------------------------------------------------------------------------------------------------------------------------------------------------------------------------------------------------------------------------------------------------------------------------------------------------------------------------------------------------------------------------------------------------------------------------------------------------------------------------------------------------------------------------------------------------------------------------------------------------------------------------------------------------------------------------------------------------------------------------------------------------------------------------------------------------------------------------------------------------------------------------------------------------------------------------------------------------------------------------------------------------------------------------------------------------------------------------------------------------------------------------------------------------------------------|
| <p>容量 Capacitance</p> | <p>恒流放电法测量 Measurement by Permanent electrotransport:</p> <ol style="list-style-type: none"> 恒流/恒压源的直流电压设定为额定电压 (U_R)。 DC voltage of constant current/constant voltage source is set as rated voltage (U_R). 设定规定的恒电流放电装置的恒定电流值。 Set the constant current value of the constant current discharge device. 将开关S切换到直流电源, 在恒流/恒压源达到额定电压后恒压充电30min。 Switch the switch S to dc power supply, and charge at constant voltage for 30min after the constant current/constant voltage source reaches the rated voltage. 在充电30min结束后, 将开关S变换到恒流放电装置, 以恒定电流进行放电。 After charging for 30min, switch S is changed to the constant exile device to discharge with constant current. <p>3、测量电容器两端电压从U_1到U_2的时间t_1和t_2, 如图所示, 根据下列等式计算电容值: Measure the time t_1 and t_2 of the voltage from U_1 to U_2 at both ends of the capacitor, as shown in the figure, and calculate the capacitance value according to the following equation</p> <p>Measurement by Permanent electrotransport:</p>  $C = \frac{I \times (t_2 - t_1)}{U_1 - U_2}$ |
| <p>内阻 Resistance</p> | <p>交流阻抗方法测量 AC impedance measurements: 采用如下图所示的电路进行测量: The circuit as shown in the figure below is used for measurement:</p>  <p>电容器的内阻R_a应通过下式计算 Capacitor resistance R_a shall be computed by the type:</p> $R_a = U/I$ <p>其中where: R_a 交流内阻 AC impedance (Ω); U 交流电压有效值 Effective value of U ac voltage (V r.m.s); I 交流电流有效值 Effective value of I ac current (V r.m.s)。</p> |
| <p>漏电流 Leakage Current</p> | <p>直流漏电流的测量原理如下 DC leakage current measurement principle is as follows:</p>  <ol style="list-style-type: none"> 放电: 该测量开始前, 电容器应进行充分放电。放电过程持续1h到24h。 Discharge: before the measurement begins, the capacitor should be fully discharged. The discharge process lasts from 1h to 24h. 漏电流的测量应额定温度和额定电压 (U_R), 经过最大30min充电时间后达到95%充电电压, 充电时间从 |

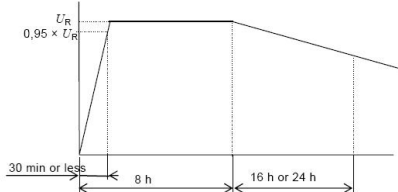
| | |
|-------------------------------|---------------------------------------------------------------------------------------------------------------------------------------------------------------------------------------------------------------------------------------------------------------------------------------------------------------------------------------------------------------------------------------------------------------------------------------------------------------------------------------------------------------------------------------------------------------------------------------------------------------------------------------------------------------|
| | <p>30min, 1h, 2h, 4h, 8h, 12h, 24h, 48h, 72h中选择并在相应标准中规定。</p> <p>Leakage current shall be measured at rated temperature and rated voltage (U_R).The charging voltage reached 95% after the maximum 30min charging time. The charging time was selected from 30min ,1h , 2h , 4h , 8h , 12h , 24h , 48h , 72h and shall be specified in the detail specification.</p> <p>3、应使用稳定的电源如直流稳压电源。 Stable power supply, such as dc stabilized power supply, should be used.</p> <p>4、通过1000Ω以下的保护电阻给电容器施加电压。 through the protection under 1000 Ω resistance to capacitor voltage.</p> |
| <p>自放电 Self discharge</p> | <p>测量开始前，电容器应进行充分放电，放电过程持续1h到24h，在电容器两端直接施加额定电压U_R，不使用保护电阻，充电时间为8h，包括电压达到施加电压95%的最大30min充电时间，将电容器两端从电压源断开。电容器应置于标准常温常压条件下放置24h。直流电压表的内阻应大于1MΩ。</p> <p>Before the measurement begins, the capacitor should be fully discharged. The discharge process lasts from 1h to 24h. The rated voltage U_R should be directly applied at both ends of the capacitor, without protection resistance. Capacitors should be placed at standard ambient temperature and pressure for 24 hours.DC voltmeter internal resistance should be greater than 1 MΩ.</p>  |

➤ 焊接条件 Soldering Condition

建议产品的焊接条件为流动焊接，如下图 The welding condition of the proposed product is flow welding, as shown below:

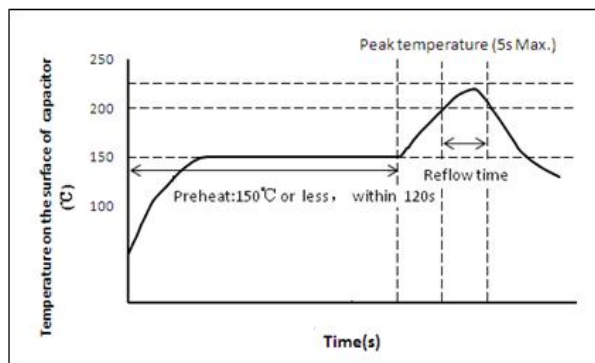

焊接时需注意 Care should be taken when welding:

1. 短时间内按照上述焊接条件，开展低温焊接工作。

Carry out low-temperature welding in accordance with the above welding conditions within a short time.

2. 当电压达到 0.3V 以上时，不要回流焊接。

When the voltage is above 0.3v, do not backflow welding.

3. 有关更多回流焊接的条件请咨询我们。

Please consult us for more conditions of reflow soldering.

➤ 使用注意事项 Cautions For Use

(1) 超级电容器极性问题 Polarity problem of supercapacitor

与普通电解电容器或电池不同的是，由于超级电容器正负极采用的是同种材质，从理论上讲是不存在极性的；而超级电容器所标识的极性是生产商在生产工艺过程制定的，当电容使用中不小心短期反向使用，不会造成电容器实质性破坏，调整为正

向可保证使用，但不可长期反向使用，会造成电容寿命特性迅速衰减。

Unlike ordinary electrolytic capacitors or batteries, the anode and cathode of supercapacitors are made of the same material, so there is no polarity in theory. However, the polarity indicated by super capacitors is formulated by the manufacturer in the production process. When the capacitor is used carelessly in the short-term reverse operation, it will not cause substantial damage to the capacitor. If adjusted to a positive direction, it can be guaranteed to be used, but it cannot be used in the long-term reverse operation, which will result in the rapid attenuation of capacitor life characteristics.

(2) 关于超级电容器充电问题 On the issue of supercapacitor charging

超级电容器充电需要采用不超过额定电压的直流电压，可采用限流、恒流、恒功率、恒电压等多种充电方式；超级电容器充电时可能会拉低充电电源电压，直到电容器充满维持电压平衡。

Charging of supercapacitors requires dc voltage which does not exceed rated voltage, and various charging methods such as current limit, constant current, constant power and constant voltage can be adopted. Supercapacitors can be charged by lowering the voltage of the charging power supply until the capacitors are full enough to maintain voltage balance.

(3) 超级电容器的内阻及容量问题 The problem of internal resistance and capacity of supercapacitors

在充放电过程中，超级电容器的内阻引起的 IR 降，会损失电容器的充放电效率，故电容器内阻大小在一定程度上决定了电容器品质的优劣，而由于超级电容器的内阻要大于普通电容器，在交流电路或高频率充放电过程中，电容会发热，造成寿命迅速衰减，这也是超级电容一般只用于直流电路的原因。

与普通电容器相比，超级电容器具有较大的时间常数 τ ，所以充放电时间均较长，也正因为如此，不适合连续的大电流频繁工作，会引起发热性能迅速衰减。超级电容器的频率特性表现为高频率下，碳电极微孔中的正负离子响应时间较长，故表现的容量很小。不可采用普通测量电容器设备交流测量容量，而是要采用基于电池测量 mAh 方法进行测试。

In the process of charging and discharging, super capacitor resistance caused by the IR drop, lose efficiency of capacitor charging and discharging, so the size of capacitor resistance to a certain extent, determines the actor bad of character of capacitor, due to the internal resistance of the super capacitor than normal capacitors, in the process of communication charge and discharge circuit or high frequency, capacitor will fever, cause life decay quickly, which is the cause of the super capacitor only commonly used in dc.

Compared with ordinary capacitors, supercapacitors have a larger time constant, so the charge-discharge time is relatively long, and because of this, it is not suitable for continuous large current to work frequently, which will cause rapid attenuation of the heating performance. The frequency characteristic of supercapacitors is that the response time of positive and negative ions in the micro pores of carbon electrode is long at high frequency. Instead of measuring capacitors' ac capacity, the mAh method based on battery measurement is used.

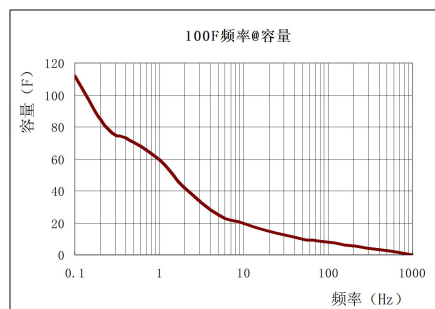

(4) 运输及储存 Transport and storage

产品运输过程应防止产品受潮，储存温度应为-30℃~50℃、相对湿度小于 60%，最大湿度不可超过 85%，否则会导致电容受潮性能劣化或生锈。

Should prevent products be affected with damp be affected with damp in product transportation, storage temperature should be -30 °C to 50 °C, relative humidity less than 60%, the maximum humidity no more than 85%, otherwise it will cause capacitance performance degradation of be affected with damp be affected with damp or rust.

(5) 安装与焊接 Installation and welding

超级电容器用于双面电路板上时，要注意连接处不可经过电容器可触及的地方，否则会导致产品短路过压及电容器损坏。安装过程及安装后，不可强行扭动或倾斜电容器，不得用力拉拽引线，应先断针及折弯后焊接。在焊接过程中要避免使电容器过热（1.6mm 的印刷线路板，焊接时应为 260℃，时间不超过 5s），焊接后，线路板和电容器要清洗于净。

When the supercapacitor is used on the double-sided circuit board, it should be noted that the connection cannot pass through the reach of the capacitor, otherwise the product will be short circuit overvoltage and the capacitor will be damaged. During installation and after installation, do not twist or tilt the capacitor by force. Do not pull the lead by force. Break the needle and weld after bending. In the welding process to avoid overheating of the capacitor (1.6 mm of printed circuit board, the welding should be 260 °C, when time is not more than 5 s), after welding, circuit board and the capacitor to clean in the net.

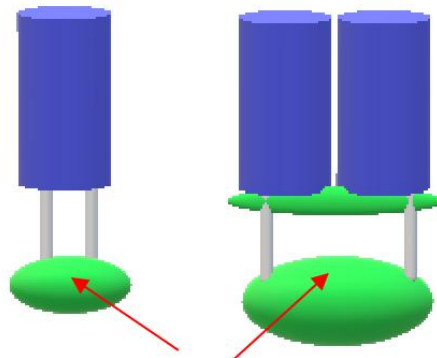

此处尽量不要布线

(6) 超级电容器短路判断 Short circuit judgment of supercapacitor

短路电容应不能进行充放电，在电容正负极间施加直流电压，电容电压不升高，可判定短路，用万用表判定时，新电容在为充电时，以欧姆档测量（短路挡）指示为短路状态，是正常现象，不能确定电容即为短路，应观察阻值是否增加，如增加即为非短路。

The short circuit capacitance shall not be charged or discharged. The dc voltage shall be applied between the positive and negative terminals of the capacitance. The capacitance voltage shall not be increased

When charging, it is normal to use ohm gauge (short circuit block) indicator as short circuit state. Capacitance is short circuit and it cannot be determined. It should be observed whether the resistance value increases or not.

(7) 串联及并联使用问题 Series and parallel operation problem

相同超级电容器串联使用时，总电压=串联个数×单体耐压；总容量=单体容量÷串联个数；总能量=串联个数×单体容量，总内阻=串联个数×单体内阻。

三个及以上串联存在单体间的电压均衡问题，需要考虑采用均衡电路，用于保证长期使用过程中电容不能过电压使用，从而引起电容器寿命衰减及损坏。不同规格超级电容器不可进行串联使用。

超级电容器进行并联使用时，可以不同容值的并联，采用相同电压充电，但要注意各个电容之间的电流平衡问题以及相互隔离，避免由于放电后电势差产生的相互反向充电。

When the same super capacitor is used in series, the total voltage = series number * monomer withstand voltage; Total capacity = unit capacity Total energy = series number x monomer capacity, total internal resistance = series number x monomer resistance.

There is a problem of voltage balancing between three or more monomers in series, so it is necessary to consider adopting equalizing circuit to ensure that the capacitance cannot be used over voltage during long-term use, thus causing capacitor life attenuation and damage. Supercapacitors of different specifications cannot be used in series.

When the super capacitors are used in parallel, they can be connected in parallel with different capacitance values and charged by the same voltage. However, it is necessary to pay attention to the current balance between the capacitors and to isolate each other, so as to avoid reverse charging due to the potential difference after discharge.

(8) 其它使用上的问题，请向生产厂家咨询或参照超级电容器使用说明的相关技术资料执行。

For other problems in use, please consult the manufacturer or refer to the relevant technical data of the instructions for the use of supercapacitors.

(9) 漏液情况处理 Handling of leakage situation

皮肤接触：用肥皂水和清水彻底冲洗皮肤；

Skin contact: rinse skin thoroughly with soap and water;

眼睛接触：用流动清水或生理盐水冲洗，就医；

Eye contact: flush with flowing water or normal saline and seek medical advice;

吸取：立即用水漱口，就医；

Absorb: immediately rinse with water and seek medical advice;

如果发现超级电容器过热或是闻到气味，应立即断开与超级电容器连接的电源和负载，让其降温，然后进行正确处理，不可让脸或手接触过热的超级电容器。

If the supercapacitor is found to be overheating or smelling, the power supply and load connected to the supercapacitor should be disconnected immediately to cool it, and the supercapacitor should be treated properly so that no face or hand contact with the supercapacitor is allowed.