



Parameter	Symbol	Rating	Units
Load Voltage	V_L	60	V
Load Current	I_L	1.1	A
On-Resistance	R_{on}	0.27	Ω
On-Resistance	V_{io}	5000	Vrms



SMD-8

DIP-8

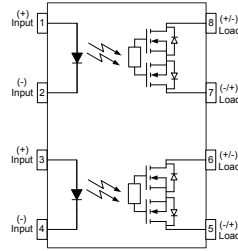

1,3. LED Anode
2,4. LED Cathode
5,6. Drain (MOS FET)
7,8. Drain (MOS FET)

(1) 2 input

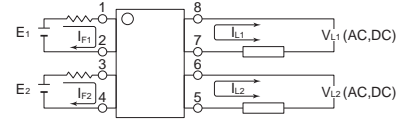

(2) 1 input

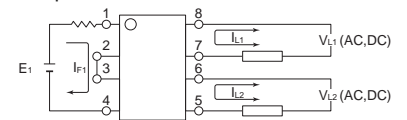

SUPSiC PhotoRelays

- Long life (No limit on mechanical and electrical lifetime)
- Bounce-free switching
- Higher speed and high frequency switching
- Higher sensitivity (less power consumption)
- Immunity to EMI or RFI
- No have voltaic arc, bounce, and noise
- resistant to vibration and impact
- AC or DC load
- switching
- Small package size

Applications

- Telecom/Datacom switching
- Multiplexers
- Meter reading systems
- Data acquisition
- Medical equipment
- Battery monitoring
- I/O Sub-Systems
- Robotics
- Aerospace
- Home/Safety security systems
- Process Control
- Energy Management
- Reed Relay EMR Replacement
- Programmable Controllers

TPYES

Category	Output Rating		Package	Part No.	Packing Quantity
	Load Voltage	Load Current			
AC/DC	60V	1100mA	DIP-8	GAQW212G1E	50pcs /tube
			SMD-8	GAQW212G1EH	1000pcs /reel

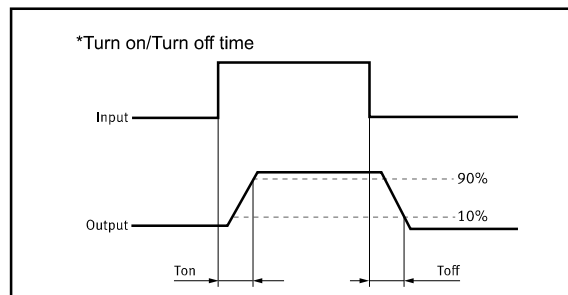

Absolute Maximum Ratings (Ta = 25°C)

Item		Symbol	Value	Units	Note
Input	Continuous LED Current	I_F	50	mA	
	Peak LED Current	I_{FP}	1000	mA	f=100Hz, duty=1%
	LED Reverse Voltage	V_R	5	V	
	Input Power Dissipation	P_{In}	75	mW	
Output	Load Voltage	V_L	60	V(AC peak or DC)	
	Load Current	I_L	1.1	A	
	Peak Load Current	I_{Peak}	2.5	A	100ms(1 pulse)
	Output Power Dissipation	P_{out}	450	mW	
Total Power Dissipation		P_T	500	mW	
I/O Breakdown Voltage		$V_{I/O}$	5000	Vrms	RH=60%, 1min
Operating Temperature		T_{opr}	-40 to 85	°C	
Storage Temperature		T_{sig}	-40 to 100	°C	
Pin Soldering Temperature		T_{sol}	260	°C	10 sec max.

Electrical Characteristics (Ta = 25°C)

Item		Symbol	MIN.	TYP.	MAX.	Units	Conditions
Input	LED Forward Voltage	V_F		1.2	1.4	V	$I_F=10mA$
	Operation LED Current	I_{Fon}		0.5	3.0	mA	
	Recovery LED Current	I_{Foff}		0.35	0.5	mA	
	Recovery LED Voltage	V_{Foff}	0.5			V	
Output	On-Resistance	R_{on}		0.27	0.7	Ω	$I_F=5mA, I_L=Max$ Time to flow is within 1 sec.
	Off-State Leakage Current	I_{Leak}			1	μA	$V_L=Rating$
	Output Capacitance	C_{out}		115		pF	$V_L=0, f=1MHz$
Transmis sion	Turn-On Time	T_{on}		1.5	5.0	ms	$I_F=5mA, I_L=Max$
	Turn-Off Time	T_{off}		0.05	2.0	ms	
Coupled	I/O Isolation Resistance	$R_{I/O}$	10^{10}			Ω	DC500V
	I/O Capacitance	$C_{I/O}$		0.8	1.5	pF	f=1MHz

Please obey the following conditions to ensure proper device operation and resetting. Input LED current (Recommended value): $I_F \geq 5mA$ and $\leq 30mA$

Engineering Data

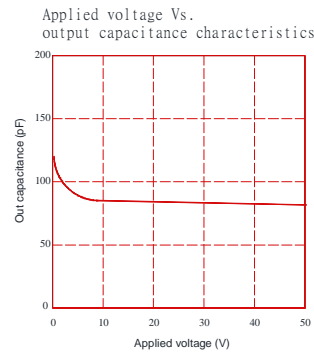
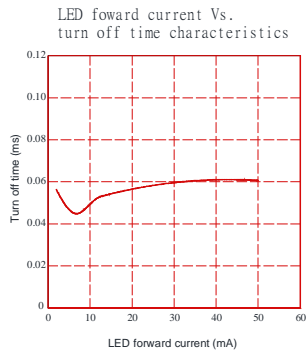
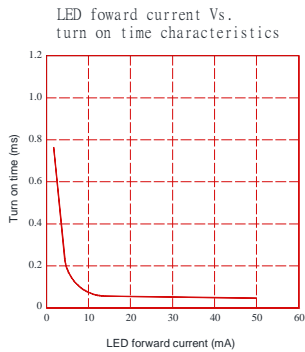
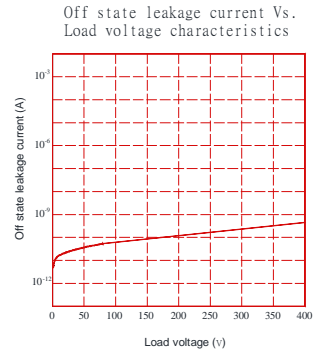
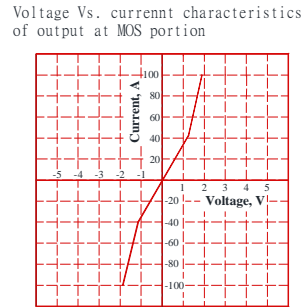
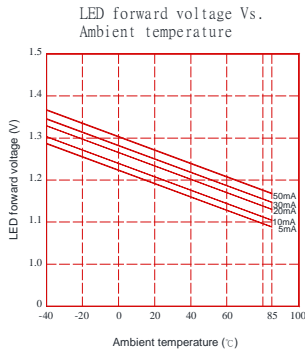
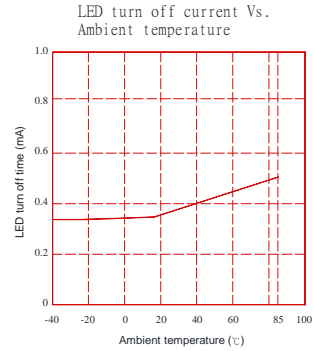
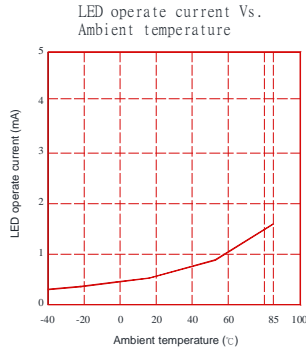
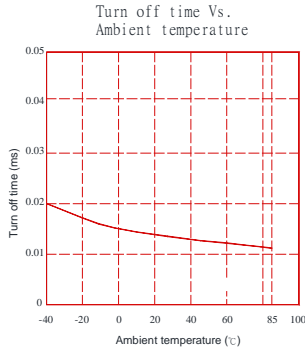
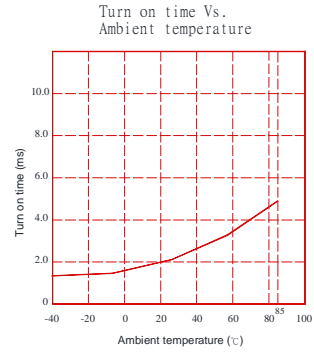
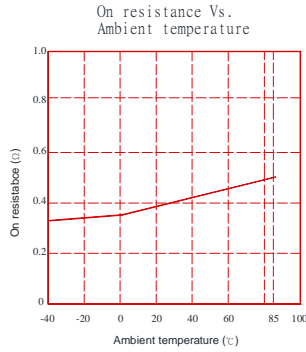
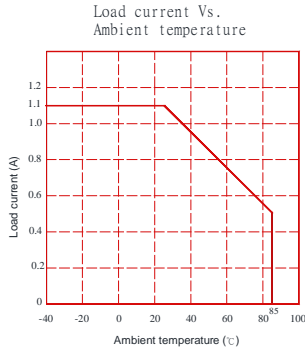

Dimensions and SMD-8 Package Unit: mm

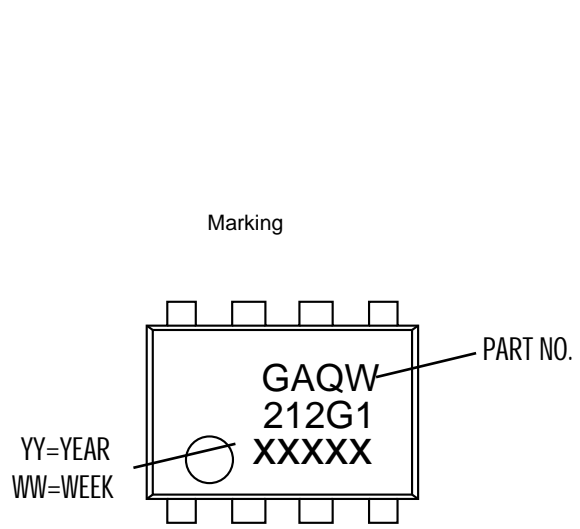

Surface mount terminal type

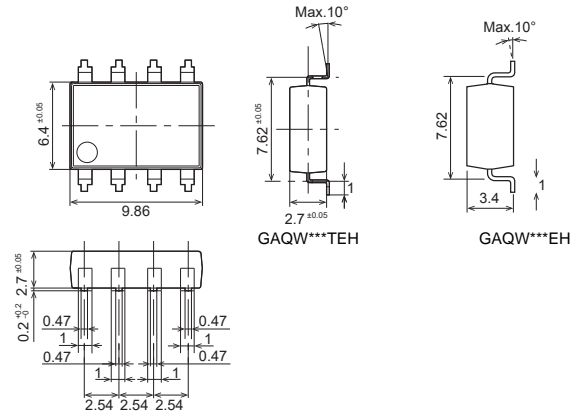

Recommended mounting pad
(Top view)

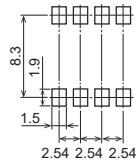

Tape dimensions (tape reel)

Tape dimensions (Unit: mm)

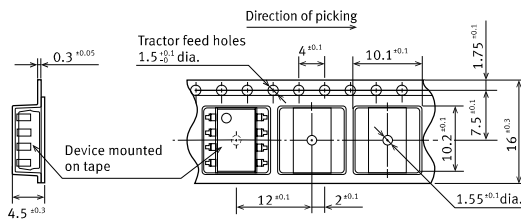

Dimensions of paper tape reel (Unit: mm)

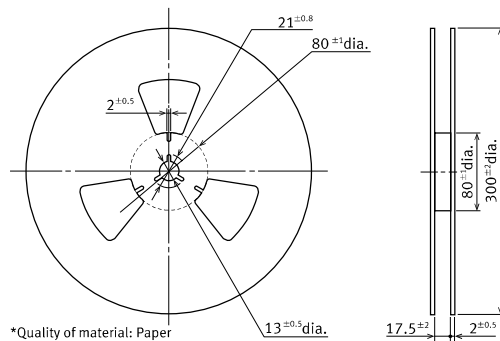

Dimensions and DIP-8 Package Unit: mm

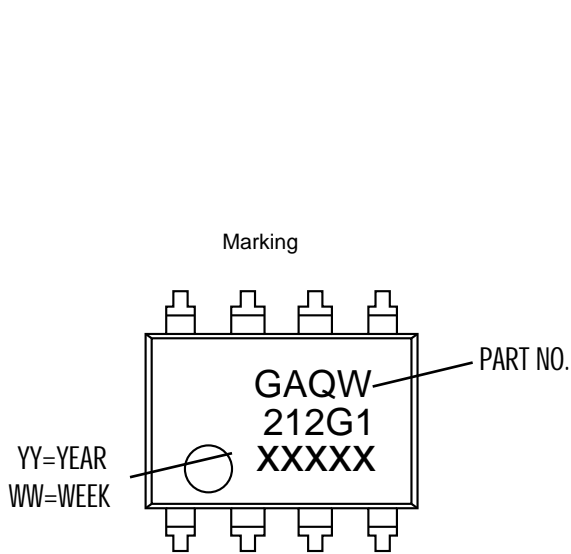

Through hole terminal type

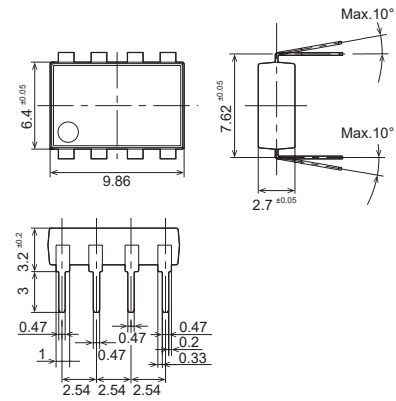

PC board pattern (Bottom view)

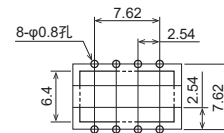

DIP Tape dimensions Unit : mm

Devices are packaged in a tube so that pin No. 1 is on the stopper B side. Observe correct orientation when mounting them on PC boards.

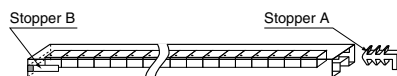

Using Methods

Examples of resistance value to control LED forward current ($I_F=5\text{mA}$)

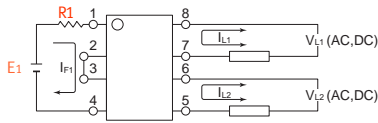

E1	R1 (Approx)
3.3V	300 Ω
5.0V	600 Ω
12V	1.9K Ω
24V	4.1K Ω

LED forward current must be more than 5mA , at I(MIN) , and less than 30mA , at I(MAX).

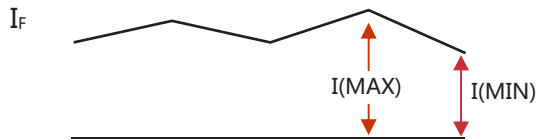

Recommended Operating Conditions

Please obey the following conditions to ensure proper device operation and resetting. Input LED current (Recommended value):

Characteristic	Symbol	Min	Typ.	Max	Unit
Forward current	I_F	5.0	7.0	30	mA

Protection Circuit

Output spike voltages:if an inductive load generates spike voltages which exceed heabsolute maximum rating, the spike voltage shall be limited.

Clamp diode is connected in parallel with the load.
Absorb capacity with external diode.

CR Snubber is connected in parallel with the load.
Absorb capacity with buffer capacity.

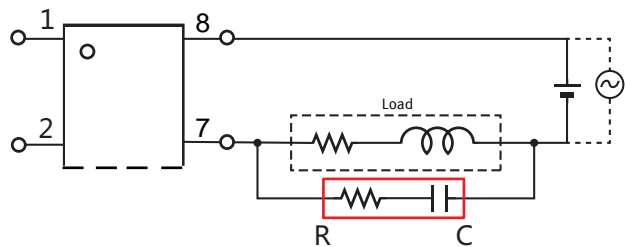
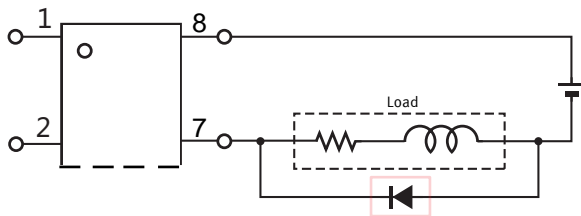

When adding diodes, buffer circuits (C-R), and other protections, they need to be installed near the MOS RELAY to be effective. Adding protection elements may result in a slow reset time, so adjust them according to the actual situation before use.

Note: When developing designs using this product, perform the expected performance of the equipment under the operating conditions recommended by the guidelines in this document. Continuous use under heavy loads (including, but not limited to, the application of high temperatures/current/voltage and significant changes in temperature, etc.) may result in deterioration of the reliability of this product.