

# 2 Way-90° Power Splitter

**QCS-83+**

50Ω      4000 to 8000 MHz



CASE STYLE: GE0805C-1

## The Big Deal

- High Power handling (15W)
- Low Unbalance, 0.8 dB & 4 deg. typ.
- Industry leading combination of size/bandwidth

## Product Overview

Mini-Circuits new 90° Power Splitter, model: QCS-83+, offers an industry leading combination of operating bandwidth and size; supporting nearly an octave band in a miniature EIA-0805 form factor. The outstanding phase and amplitude unbalance make this component a versatile building block for use in a variety of systems and sub-system designs.

## Key Features

Feature	Advantages
Small Size	Offered in the EIA-0805 package size, the QCS-83+ offers an industry leading combination of size, bandwidth and frequency. The small footprint (2.0mm x 1.25mm) allows for reduced parasitics in systems with improved performance and simplified layout.
Low Phase and Amplitude Unbalance	Supporting 4 deg. and 0.8 dB unbalance make this 90° hybrid applicable for use in higher level integrated components such as image reject mixers, single sideband modulators, phase shifters, variable attenuators, and balance amplifiers.
High Power Handling	Capable of operating up to 15W, the LTCC construction of the QCS-83+ makes this 90° hybrid a robust, rugged product that can be used effectively in either the transmit or receive paths.

### Notes

- A. Performance and quality attributes and conditions not expressly stated in this specification document are intended to be excluded and do not form a part of this specification document.  
B. Electrical specifications and performance data contained in this specification document are based on Mini-Circuit's applicable established test performance criteria and measurement instructions.  
C. The parts covered by this specification document are subject to Mini-Circuits standard limited warranty and terms and conditions (collectively, "Standard Terms"); Purchasers of this part are entitled to the rights and benefits contained therein. For a full statement of the Standard Terms and the exclusive rights and remedies thereunder, please visit Mini-Circuits' website at [www.minicircuits.com/MCLStore/terms.jsp](http://www.minicircuits.com/MCLStore/terms.jsp)



# Power Splitter/Combiner

**QCS-83+**

2 Way-90° 50Ω 4000 to 8000 MHz



Generic photo used for illustration purposes only  
CASE STYLE: GE0805C-1

### Maximum Ratings

Operating Temperature	-55°C to 100°C
Storage Temperature	-55°C to 100°C
Power Input (as a splitter)	15W* max.

\*Derate linearly to 7W at 100°C ambient.  
Permanent damage may occur if any of these limits are exceeded.

### Pin Connections

SUM PORT	1
PORT 1 (0°)	4
PORT 2 (+90°)	6
GROUND	2,5
50 OHM TERM EXTERNAL	3

### Features

- Low insertion loss, 0.8 dB typ.
- Good isolation, 14 dB typ.
- Miniature size, 0.079"x0.049"x0.033"
- LTCC construction
- High power

### Applications

- Balanced amplifiers
- Modulators
- DCS, PCS, UMTS
- WiMax
- WiFi • ISM
- Phase Shifter
- Attenuator
- Point to Point

**+RoHS Compliant**  
The +Suffix identifies RoHS Compliance. See our web site for RoHS Compliance methodologies and qualifications

**Available Tape and Reel at no extra cost**

Reel Size	Devices/Reel
7"	20, 50, 100, 200, 500, 1000, 2000

### Outline Drawing

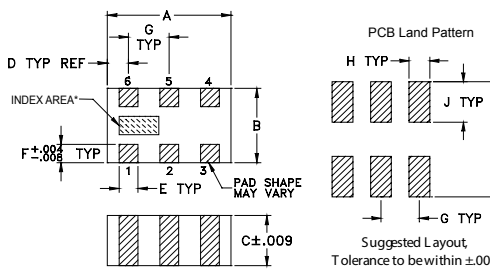

### Outline Dimensions (inch/mm)

A	B	C	D	E	F
.079	.049	.033	.014	.012	.012
2.01	1.24	0.84	0.36	0.30	0.30
G	H	J	K	wt	
.026	.014	.039	.110	grams	
0.66	0.36	1.00	2.80	.008	

### Electrical Specifications at 25°C

Parameter	Frequency (MHz)	Min.	Typ.	Max.	Unit
<b>Frequency</b>		4000		8000	MHz
<b>Insertion Loss (Avg. Of Coupled Outputs) above 3 dB</b>	4000-5000	—	0.7	1	dB
	5000-6000	—	0.7	1	
	6000-7000	—	0.8	1.1	
	7000-8000	—	1.1	1.5	
<b>Isolation</b>	4000-5000	13	16	—	dB
	5000-6000	13	16	—	
	6000-7000	16	19	—	
	7000-8000	13	16	—	
<b>Phase Unbalance</b>	4000-5000	—	3	6	Degree
	5000-6000	—	3	6	
	6000-7000	—	4	8	
	7000-8000	—	5	9	
<b>Amplitude Unbalance</b>	4000-5000	—	0.8	1.1	dB
	5000-6000	—	0.8	1.1	
	6000-7000	—	0.8	1.1	
	7000-8000	—	1.4	1.8	
<b>VSWR (Port-S)</b>	4000-8000	—	1.4	1.6	:1
<b>VSWR (Port 1-2)</b>	4000-8000	—	1.4	2.0	:1

### Electrical Schematic

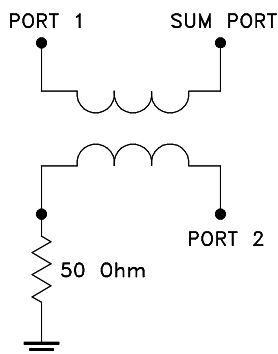

### Demo Board MCL P/N: TB-489-802+ Suggested PCB Layout (PL-304)

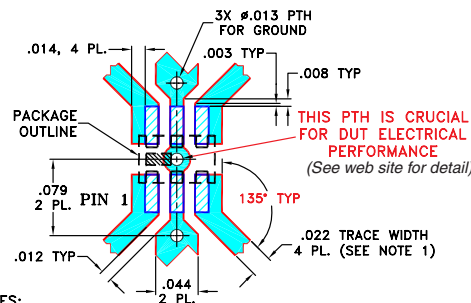

#### NOTES:

1. TRACE WIDTH IS SHOWN FOR ROGERS RO4350B WITH DIELECTRIC THICKNESS .010" ± .001"; COPPER: 1/2 OZ. EACH SIDE. FOR OTHER MATERIALS TRACE WIDTH MAY NEED TO BE MODIFIED.
2. BOTTOM SIDE OF THE PCB IS CONTINUOUS GROUND PLANE.

- DENOTES PCB COPPER LAYOUT WITH SMOBC (SOLDER MASK OVER BARE COPPER)
- ▨ DENOTES COPPER LAND PATTERN FREE OF SOLDER MASK

#### Notes

- A. Performance and quality attributes and conditions not expressly stated in this specification document are intended to be excluded and do not form a part of this specification document.
- B. Electrical specifications and performance data contained in this specification document are based on Mini-Circuit's applicable established test performance criteria and measurement instructions.
- C. The parts covered by this specification document are subject to Mini-Circuits standard limited warranty and terms and conditions (collectively, "Standard Terms"); Purchasers of this part are entitled to the rights and benefits contained therein. For a full statement of the Standard Terms and the exclusive rights and remedies thereunder, please visit Mini-Circuits' website at [www.minicircuits.com/MCLStore/terms.jsp](http://www.minicircuits.com/MCLStore/terms.jsp)



## Typical Performance Data

Frequency (MHz)	Total Loss <sup>1</sup> (dB)		Amplitude Unbalance (dB)	Isolation (dB)	Phase Unbalance (deg.)	VSWR S	VSWR 1	VSWR 2
	S-1	S-2						
4000.00	3.51	4.15	0.22	16.82	91.24	1.34	1.29	1.28
4200.00	3.69	3.97	0.08	16.26	91.04	1.36	1.32	1.29
4500.00	3.89	3.74	0.43	15.85	90.62	1.36	1.36	1.30
4800.00	4.02	3.58	0.66	15.74	90.24	1.35	1.36	1.30
5000.00	4.06	3.49	0.74	15.95	90.11	1.33	1.35	1.28
5200.00	4.08	3.41	0.79	16.21	90.29	1.29	1.32	1.26
5500.00	4.08	3.31	0.81	17.14	90.85	1.24	1.25	1.23
5800.00	4.06	3.27	0.79	18.43	91.66	1.18	1.18	1.19
6000.00	4.07	3.30	0.78	19.71	92.25	1.14	1.13	1.16
6500.00	4.12	3.36	0.73	25.97	93.94	1.06	1.02	1.07
6800.00	4.09	3.39	0.65	37.16	94.21	1.01	1.07	1.02
7000.00	4.05	3.46	0.53	35.77	94.29	1.05	1.10	1.08
7500.00	3.85	3.84	0.07	20.77	94.11	1.15	1.16	1.31
7800.00	3.67	4.24	0.73	17.08	94.26	1.26	1.21	1.52
8000.00	3.55	4.55	1.31	15.41	94.99	1.36	1.28	1.70

1. Total Loss = Insertion Loss + 3dB splitter loss.

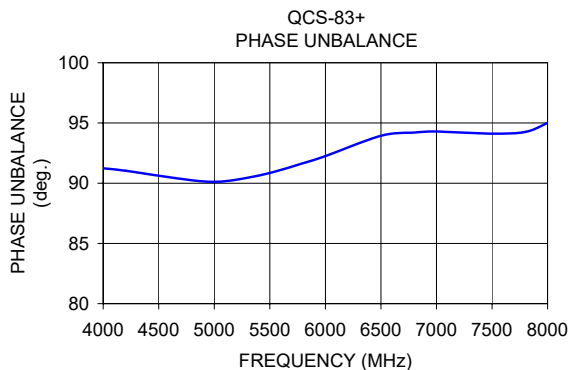
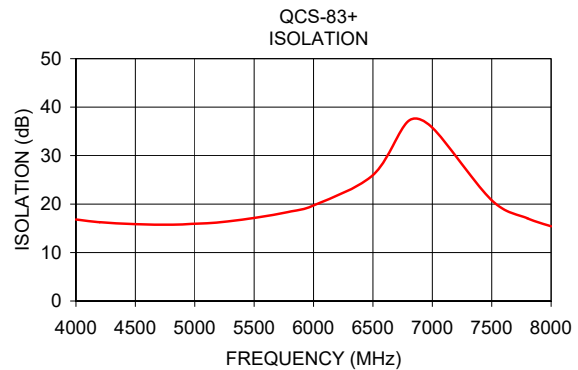
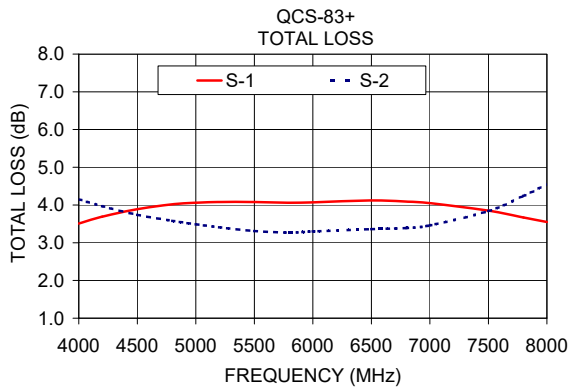

### Notes

- A. Performance and quality attributes and conditions not expressly stated in this specification document are intended to be excluded and do not form a part of this specification document.
- B. Electrical specifications and performance data contained in this specification document are based on Mini-Circuit's applicable established test performance criteria and measurement instructions.
- C. The parts covered by this specification document are subject to Mini-Circuit's standard limited warranty and terms and conditions (collectively, "Standard Terms"); Purchasers of this part are entitled to the rights and benefits contained therein. For a full statement of the Standard Terms and the exclusive rights and remedies thereunder, please visit Mini-Circuit's website at [www.minicircuits.com/MCLStore/terms.jsp](http://www.minicircuits.com/MCLStore/terms.jsp)



# 2 Way-90° Power Splitter/Combiner

**QCS-83+**

## Typical Performance Data

FREQ. (MHz)	TOTAL LOSS <sup>1</sup> (dB)		AMP. UNBAL. (dB)	ISOLATION (dB)	PHASE UNBAL. (Deg.)	FREQ. (MHz)	VSWR (:1)		
	S-1	S-2					S	1	2
	4000.0	3.51					4.15	0.22	16.82
4050.0	3.55	4.11	0.14	16.66	91.19	4050.0	1.34	1.29	1.28
4100.0	3.60	4.05	0.06	16.51	91.15	4100.0	1.35	1.30	1.29
4150.0	3.65	4.01	0.01	16.36	91.11	4150.0	1.36	1.31	1.29
4200.0	3.69	3.97	0.08	16.26	91.04	4200.0	1.36	1.32	1.29
4250.0	3.73	3.92	0.15	16.15	90.98	4250.0	1.36	1.33	1.30
4300.0	3.76	3.89	0.21	16.07	90.92	4300.0	1.37	1.34	1.30
4350.0	3.80	3.84	0.27	15.99	90.83	4350.0	1.37	1.34	1.31
4400.0	3.84	3.81	0.33	15.88	90.78	4400.0	1.37	1.35	1.30
4450.0	3.86	3.77	0.38	15.88	90.70	4450.0	1.37	1.36	1.30
4500.0	3.89	3.74	0.43	15.85	90.62	4500.0	1.36	1.36	1.30
4550.0	3.92	3.70	0.48	15.78	90.54	4550.0	1.37	1.36	1.31
4600.0	3.94	3.68	0.52	15.79	90.50	4600.0	1.37	1.36	1.30
4650.0	3.97	3.65	0.57	15.74	90.45	4650.0	1.36	1.37	1.30
4700.0	3.99	3.62	0.60	15.75	90.34	4700.0	1.36	1.37	1.30
4750.0	4.00	3.60	0.63	15.79	90.30	4750.0	1.35	1.37	1.30
4800.0	4.02	3.58	0.66	15.74	90.24	4800.0	1.35	1.36	1.30
4850.0	4.03	3.56	0.68	15.79	90.22	4850.0	1.35	1.36	1.29
4900.0	4.05	3.53	0.71	15.79	90.16	4900.0	1.34	1.36	1.29
4950.0	4.05	3.51	0.73	15.85	90.13	4950.0	1.34	1.35	1.28
5000.0	4.06	3.49	0.74	15.95	90.11	5000.0	1.33	1.35	1.28
5050.0	4.06	3.47	0.76	15.96	90.14	5050.0	1.32	1.34	1.28
5100.0	4.07	3.45	0.77	16.06	90.18	5100.0	1.32	1.34	1.27
5150.0	4.08	3.42	0.78	16.16	90.22	5150.0	1.31	1.33	1.27
5200.0	4.08	3.41	0.79	16.21	90.29	5200.0	1.29	1.32	1.26
5250.0	4.08	3.39	0.80	16.42	90.33	5250.0	1.29	1.32	1.26
5300.0	4.08	3.38	0.80	16.46	90.41	5300.0	1.28	1.30	1.25
5350.0	4.08	3.36	0.80	16.59	90.53	5350.0	1.27	1.29	1.25
5400.0	4.08	3.33	0.81	16.81	90.62	5400.0	1.26	1.28	1.24
5450.0	4.08	3.33	0.81	16.92	90.71	5450.0	1.25	1.27	1.24
5500.0	4.08	3.31	0.81	17.14	90.85	5500.0	1.24	1.25	1.23
5550.0	4.08	3.31	0.81	17.31	90.99	5550.0	1.23	1.24	1.23
5600.0	4.08	3.29	0.81	17.47	91.08	5600.0	1.22	1.23	1.23
5650.0	4.07	3.28	0.80	17.72	91.22	5650.0	1.21	1.22	1.22
5700.0	4.07	3.27	0.80	17.87	91.38	5700.0	1.21	1.20	1.21
5750.0	4.07	3.28	0.80	18.10	91.50	5750.0	1.19	1.19	1.20
5800.0	4.06	3.27	0.79	18.43	91.66	5800.0	1.18	1.18	1.19
5850.0	4.07	3.27	0.80	18.65	91.82	5850.0	1.18	1.16	1.18
5900.0	4.07	3.28	0.79	18.94	91.96	5900.0	1.17	1.15	1.19
5950.0	4.07	3.28	0.78	19.25	92.11	5950.0	1.16	1.14	1.17
6000.0	4.07	3.30	0.78	19.71	92.25	6000.0	1.14	1.13	1.16
6100.0	4.07	3.32	0.77	20.37	92.61	6100.0	1.13	1.09	1.14
6200.0	4.07	3.34	0.76	21.55	93.02	6200.0	1.10	1.07	1.12
6300.0	4.08	3.35	0.75	22.65	93.35	6300.0	1.09	1.05	1.11
6400.0	4.10	3.35	0.74	24.16	93.67	6400.0	1.07	1.03	1.08
6500.0	4.12	3.36	0.73	25.97	93.94	6500.0	1.06	1.02	1.07
6600.0	4.13	3.36	0.73	28.47	94.06	6600.0	1.04	1.03	1.04
6700.0	4.11	3.37	0.70	31.65	94.12	6700.0	1.02	1.04	1.01
6800.0	4.09	3.39	0.65	37.16	94.21	6800.0	1.01	1.07	1.02
6900.0	4.07	3.42	0.59	42.58	94.27	6900.0	1.03	1.09	1.05
7000.0	4.05	3.46	0.53	35.77	94.29	7000.0	1.05	1.10	1.08
7100.0	4.02	3.50	0.45	30.26	94.27	7100.0	1.07	1.12	1.12
7200.0	3.99	3.57	0.35	26.80	94.26	7200.0	1.09	1.13	1.16
7300.0	3.95	3.65	0.23	24.49	94.19	7300.0	1.11	1.14	1.20
7400.0	3.90	3.74	0.09	22.32	94.15	7400.0	1.13	1.15	1.25
7500.0	3.85	3.84	0.07	20.77	94.11	7500.0	1.15	1.16	1.31
7600.0	3.79	3.97	0.26	19.27	94.11	7600.0	1.18	1.17	1.38
7700.0	3.73	4.10	0.48	18.13	94.14	7700.0	1.22	1.19	1.44
7800.0	3.67	4.24	0.73	17.08	94.26	7800.0	1.26	1.21	1.52
7900.0	3.61	4.39	1.01	16.14	94.57	7900.0	1.32	1.24	1.61
8000.0	3.55	4.55	1.31	15.41	94.99	8000.0	1.36	1.28	1.70

<sup>1</sup>Total Loss = Insertion Loss + 3dB Splitter Loss



## Typical Performance Curves

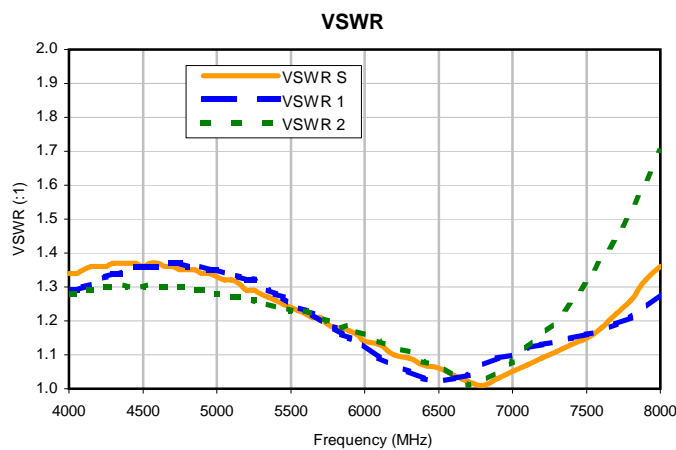
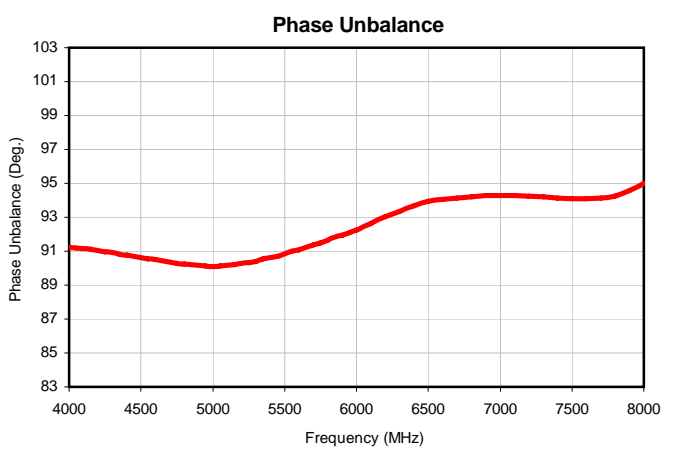
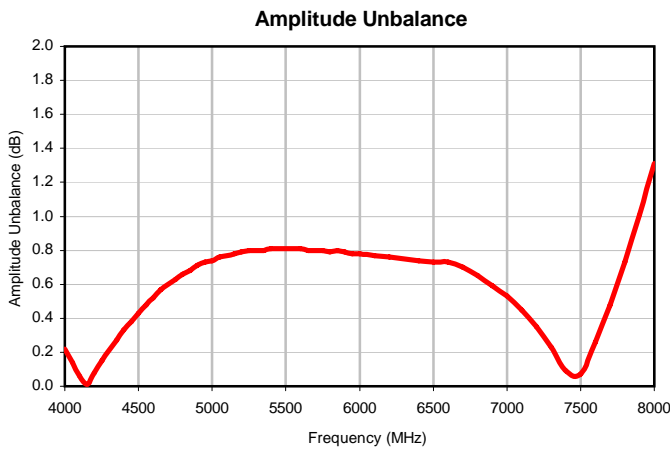
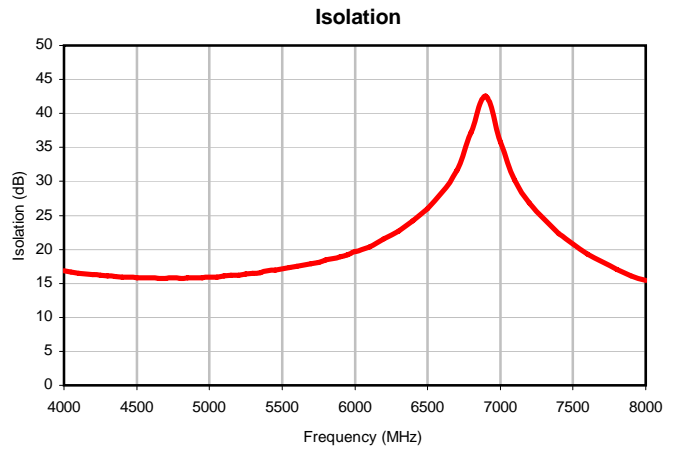
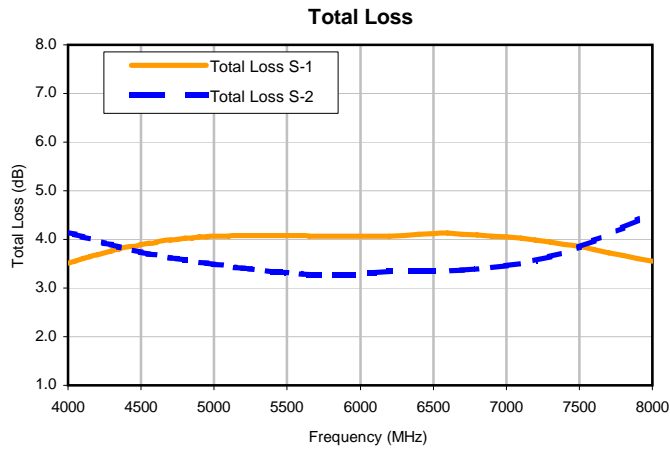

### Outline Dimensions



### PCB Land Pattern



Suggested Layout,  
Tolerance to be within  $\pm 0.002$

CASE #	A	B	C	D	E	F	G	H	J	K	WT. GRAM
GE0805C-1	.079 (2.00)	.049 (1.25)	.033 (0.84)	.014 (0.35)	.012 (0.30)	.012 (0.30)	.026 (0.65)	.014 (0.35)	.039 (1.00)	.110 (2.80)	.008

Dimensions are in inches (mm). Tolerances: 2Pl.  $\pm .01$ ; 3 Pl.  $\pm .005$

### Notes:

- Open style, ceramic base.
- Termination finish: For RoHS Case Styles: Tin plate over Nickel plate. All models, (+) suffix.  
For RoHS-5 Case Style: Tin-lead plate. All models, no (+) suffix.



P.O. Box 350166, Brooklyn, New York 11235-0003 (718) 934-4500 Fax (718) 332-4661 For detailed performance specs & shopping online see Mini-Circuits web site



The Design Engineers Search Engine Provides ACTUAL Data Instantly From MINI-CIRCUITS At: [www.minicircuits.com](http://www.minicircuits.com)

RF/IF MICROWAVE COMPONENTS

# Tape & Reel Packaging TR-F74

## DEVICE ORIENTATION IN T&R



**ILLUSTRATION 1**

### Applicable Case Styles

GE0805C-1  
 GE0805C-1AP  
 JV1210C-1  
 GU2939



**ILLUSTRATION 2**

### Applicable Case Styles

JV1210C  
 JV1210C-2  
 JV1210C-3  
 JV1210C-4  
 JV1210C-5  
 JV1210C-6  
 JV1210C-11



**ILLUSTRATION 3**

### Applicable Case Styles

JC0603C-8  
 JV1210C-7  
 JV1210C-8  
 JV1210C-9  
 JV1210C-10  
 JV1210C-13  
 GE0805C-13

Tape Width, mm	Device Cavity Pitch, mm	Real Size, inches	Devices per Reel	
8	4	7	Small quantity standards (see note)	20
				50
				100
				200
				500
			Standard	1000
				2000
			4000	

Note: Small reel availability varies by model. Refer to pricing and availability on individual model dashboard.

Mini-Circuits carrier tape materials provide protection from ESD (Electro-Static Discharge) during handling and transportation. Tapes are static dissipative and comply with industry standards EIA-481/EIA-541.

Go to: [www.minicircuits.com/pages/pdfs/tape.pdf](http://www.minicircuits.com/pages/pdfs/tape.pdf)



INTERNET <http://www.minicircuits.com>

P.O. Box 350166, Brooklyn, New York 11235-0003 (718) 934-4500 Fax (718) 332-4661

Distribution Centers NORTH AMERICA 800-654-7949 • 417-335-5935 • Fax 417-335-5945 • EUROPE 44-1252-832600 • Fax 44-1252-837010

Mini-Circuits ISO 9001 & ISO 14001 Certified

THIRD ANGLE PROJECTION

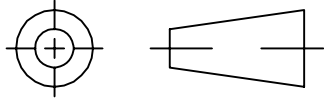

REVISIONS

REV	ECN No.	DESCRIPTION	DATE	DR	AUTH
OR	M122595	NEW RELEASE	04/27/09	MMG	ABD

SUGGESTED MOUNTING CONFIGURATION FOR  
GE0805C-1 CASE STYLE, "06SQ07" PIN CODE

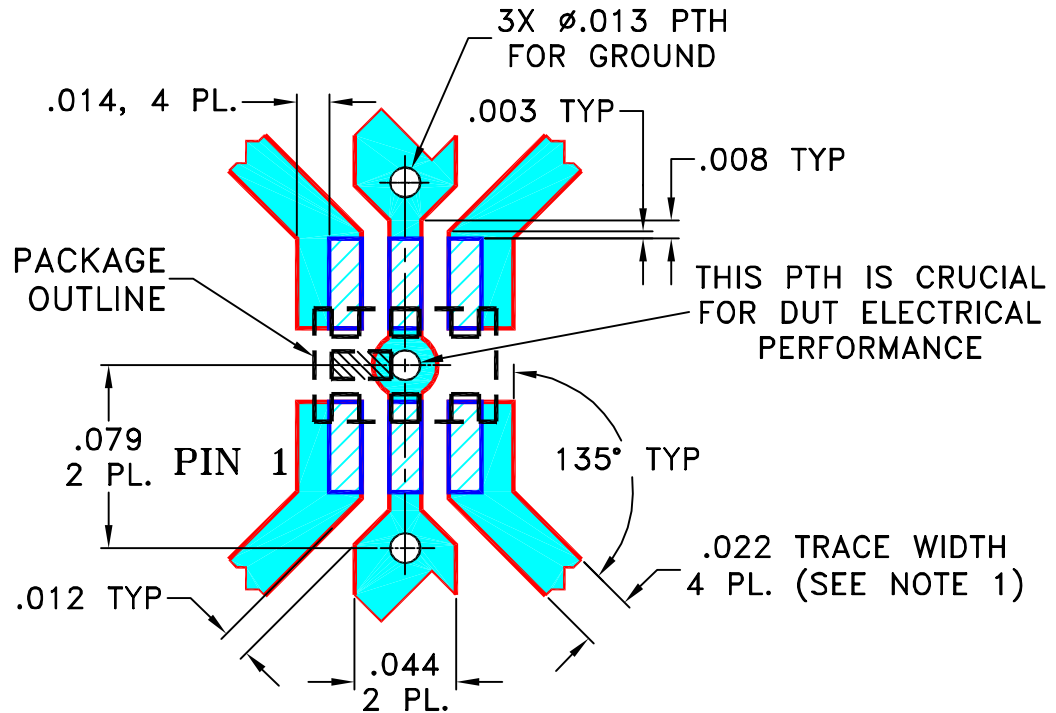

- NOTES: 1. TRACE WIDTH IS SHOWN FOR ROGERS RO4350B WITH DIELECTRIC THICKNESS .010" ± .001"; COPPER: 1/2 OZ. EACH SIDE. FOR OTHER MATERIALS TRACE WIDTH MAY NEED TO BE MODIFIED.  
2. BOTTOM SIDE OF THE PCB IS CONTINUOUS GROUND PLANE.



DENOTES PCB COPPER LAYOUT WITH SMOBC (SOLDER MASK OVER BARE COPPER)



DENOTES COPPER LAND PATTERN FREE OF SOLDER MASK

UNLESS OTHERWISE SPECIFIED

INITIALS

DATE

DIMENSIONS ARE IN INCHES

DRAWN

MMG

04/27/09

TOLERANCES ON:

CHECKED

AV

04/27/09

2 PL DECIMALS ±

APPROVED

ABD

04/27/09

3 PL DECIMALS ± .005

ANGLES ± 1°

FRACTIONS ±

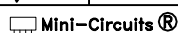

Mini-Circuits®

13 Neptune Avenue  
Brooklyn NY 11235

PL, 06SQ07, GE0805C-1, TB-489+

THIS DOCUMENT AND ITS CONTENTS ARE THE PROPERTY OF MINI-CIRCUITS. EXCEPT FOR USE EXPRESSLY GRANTED, IN WRITING, TO ITS VENDORS, VENDEE AND THE UNITED STATES GOVERNMENT, MINI-CIRCUITS RESERVES ALL PROPRIETARY DESIGN, USE, MANUFACTURING AND REPRODUCTION RIGHTS THERETO. THESE CONTENTS SHALL NOT BE USED, DUPLICATED OR DISCLOSED TO ANY OUTSIDE PARTY, IN WHOLE OR IN PART, WITHOUT WRITTEN PERMISSION OF MINI-CIRCUITS.

SIZE  
A

CODE IDENT  
15542

DRAWING NO:  
98-PL-304

REV:  
OR

FILE: 98PL304

SCALE: 12:1

SHEET: 1 OF 1

ASHEETA1.DWG REV:A DATE:01/12/95



# Evaluation Board and Circuit

For Pin Connections refer to Data Sheet of the DUT

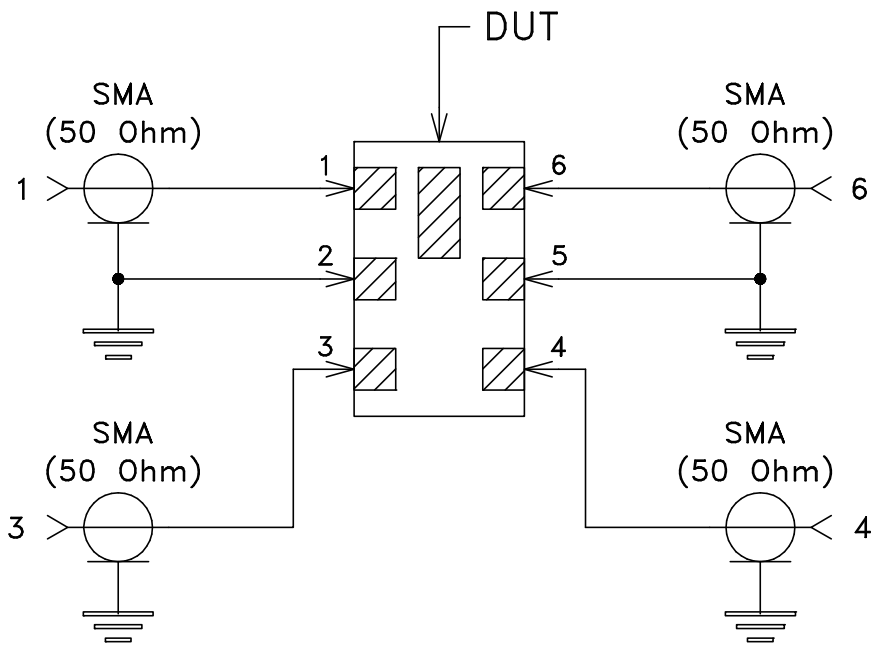
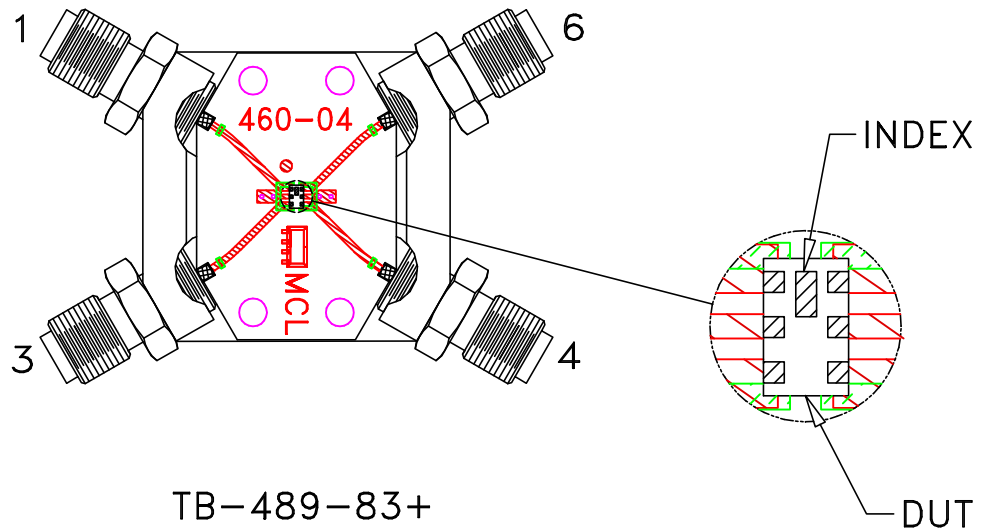

Schematic Diagram

## Notes:

1. 50 Ohm SMA Female connectors.
2. PCB Material: Rogers R04350 or equivalent, Dielectric Constant=3.5, Thickness=.010 inch.

 **Mini-Circuits®**

All Mini-Circuits products are manufactured under exacting quality assurance and control standards, and are capable of meeting published specifications after being subjected to any or all of the following physical and environmental test.

<b>Specification</b>	<b>Test/Inspection Condition</b>	<b>Reference/Spec</b>
Operating Temperature	-55° to 100°C Ambient Environment	Individual Model Data Sheet
Storage Temperature	-55° to 100° C Ambient Environment	Individual Model Data Sheet
Barometric Pressure	100,000 Feet	MIL-STD-202, Method 105, Condition D
Humidity	90% RH, 65°C Units may require bake-out after humidity to restore full performance.	MIL-STD-202, Method 103
Thermal Shock	-65° to 125°C, 5 cycles	MIL-STD-202, Method 107, Condition B
Vibration (High Frequency)	20g peak, 10-2000 Hz, 12 times in each of three perpendicular directions (total 36)	MIL-STD-202, Method 204, Condition D
Mechanical Shock	100g, 6ms sawtooth, 3 shocks each direction 3 axes (total 18)	MIL-STD-202, Method 213, Condition I