

144432-1 ✓ ACTIVE



AMP | Junior Power Timer, Timer Connector System

TE Internal #: 144432-1

Receptacle, Mating Tab Width 2.8 mm [.11 in], Tab Thickness .8 mm [.031 in], 17 – 12 AWG Wire Size, Timer Connector System, Automotive Terminals

[View on TE.com >](#)

Terminals & Splices > Automotive Terminals



Terminal Type: **Receptacle**

Mating Tab Width: **2.8 mm [.11 in]**

Mating Tab Thickness: **.8 mm [.031 in]**

Terminal Transmits: **0 – 24 A (Low Power)**

Wire Size: **17 – 12 AWG**

Features

Product Type Features

Receptacle Style	180°
Sealable	No
Primary Locking Feature	Locking Lance

Contact Features

Contact Size	2.8mm
Contact Fabrication	Stamped & Formed
Wire Contact Termination Area Plating Material	Tin
Typical Current Rating	5 A
Crimp Type	F-Crimp
Terminal Type	Receptacle
Mating Tab Width	2.8 mm [.11 in]
Mating Tab Thickness	.8 mm [.031 in]
Interface Plating	Tin (Sn)

Termination Features

Termination Method to Wire & Cable	Crimp
Product Terminates To	Wire

Dimensions



Compatible Insulation Diameter Range	3.5 mm[.137 in]
Wire Size	1 – 3 mm ²
Wire Size Search	12 AWG, 13 AWG, 14 AWG, 15 AWG, 16 AWG, 17 AWG

Usage Conditions

Insulation Option	Uninsulated
Operating Temperature (Max)	80 °C, 85 °C, 90 °C, 100 °C[176 °F][185 °F] [194 °F][212 °F]
Operating Temperature Range	-40 – 100 °C[-40 – 212 °F]

Operation/Application

Compatible With Wire Base Material	Copper
------------------------------------	--------

Packaging Features

Packaging Quantity	3000
Packaging Method	Reel

Other

Terminal Transmits	0 – 24 A (Low Power)
--------------------	----------------------

Product Compliance

[For compliance documentation, visit the product page on TE.com>](#)

EU RoHS Directive 2011/65/EU	Compliant
EU ELV Directive 2000/53/EC	Compliant
China RoHS 2 Directive MIIT Order No 32, 2016	No Restricted Materials Above Threshold
EU REACH Regulation (EC) No. 1907/2006	Current ECHA Candidate List: JUNE 2024 (241) Candidate List Declared Against: JUNE 2024 (241) Does not contain REACH SVHC
Halogen Content	Low Halogen - Br, Cl, F, I < 900 ppm per homogenous material. Also BFR/CFR/PVC Free
Solder Process Capability	Not applicable for solder process capability

Product Compliance Disclaimer

This information is provided based on reasonable inquiry of our suppliers and represents our current actual knowledge based on the information they provided. This information is subject to change. The part numbers that TE has identified as EU RoHS compliant have a maximum concentration of 0.1% by weight in homogenous materials for lead, hexavalent chromium, mercury, PBB, PBDE, DBP, BBP, DEHP, DIBP, and 0.01% for cadmium, or qualify for an exemption to these limits as defined in the Annexes of Directive 2011/65/EU (RoHS2). Finished electrical and electronic equipment products

will be CE marked as required by Directive 2011/65/EU. Components may not be CE marked. Additionally, the part numbers that TE has identified as EU ELV compliant have a maximum concentration of 0.1% by weight in homogenous materials for lead, hexavalent chromium, and mercury, and 0.01% for cadmium, or qualify for an exemption to these limits as defined in the Annexes of Directive 2000/53/EC (ELV). Regarding the REACH Regulation, the information TE provides on SVHC in articles for this part number is based on the latest European Chemicals Agency (ECHA) 'Guidance on requirements for substances in articles' posted at this URL: <https://echa.europa.eu/guidance-documents/guidance-on-reach>

Compatible Parts



TE Part # 1579007-1
AUSDRUECKWERKZEUG



TE Part # CAT-T4827-CH8172
Timer Connector Housing



TE Part # 185402-1
MODULAR RELAY HOLDER

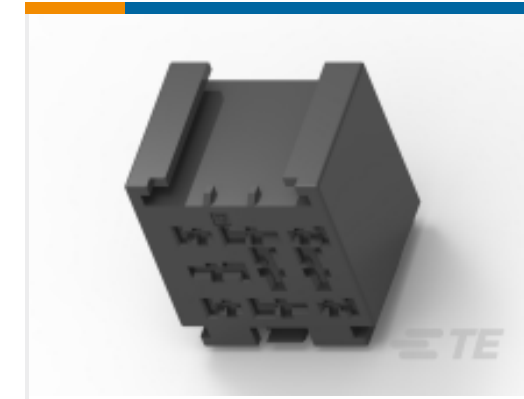

TE Part # 185403-2
MODULAR RELAY HOLDER



TE Part # 3-1579007-1
EXTRACTION TOOL



TE Part # 185402-2
MODULAR RELAY HOLDER



TE Part # 2837084-1
OCEAN_2.0_APPLICATOR-S-110F155F-RSM



TE Part # 2837084-2
OCEAN_2.0_APPLICATOR-S-110F155F-RSA



TE Part # 7-2837084-7
OCEAN_2.0_SPARE_PART_KIT-110F155F



TE Part # 185403-1
MODULAR RELAY HOLDER



TE Part # 144471-5
CET 2 POS ASSY JPT



TE Part # 144473-6
CET 2 POS ASSY JPT

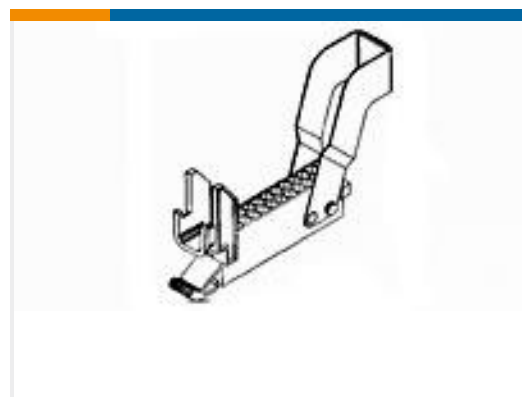

TE Part # 185167-1
25W JPT PLUG CONNECTOR

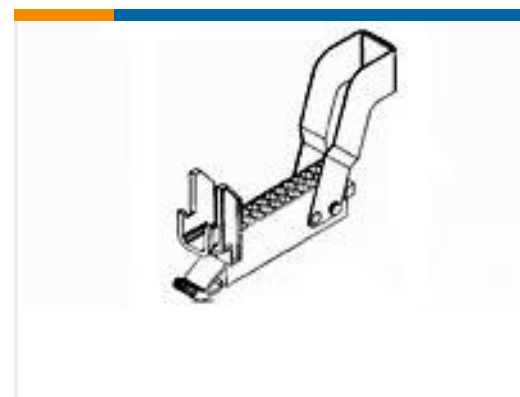

TE Part # 185167-5
25W JPT PLUG CONNECTOR



TE Part # 144169-1
8 POSITIONS MODULE



TE Part # 144473-4
CET 2 POS ASSY JPT



Also in the Series | Junior Power Timer

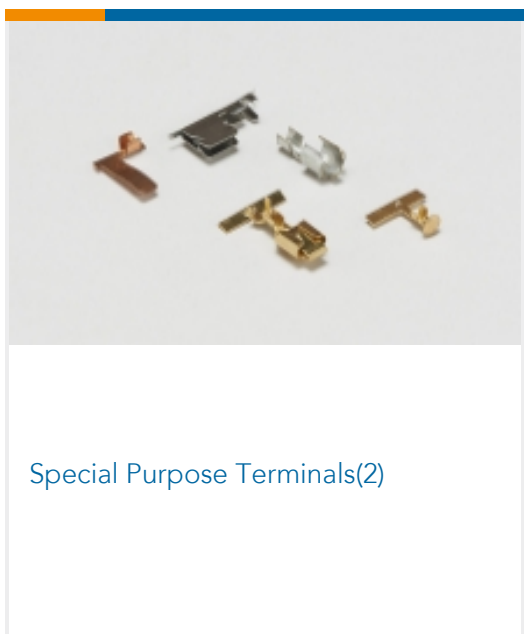
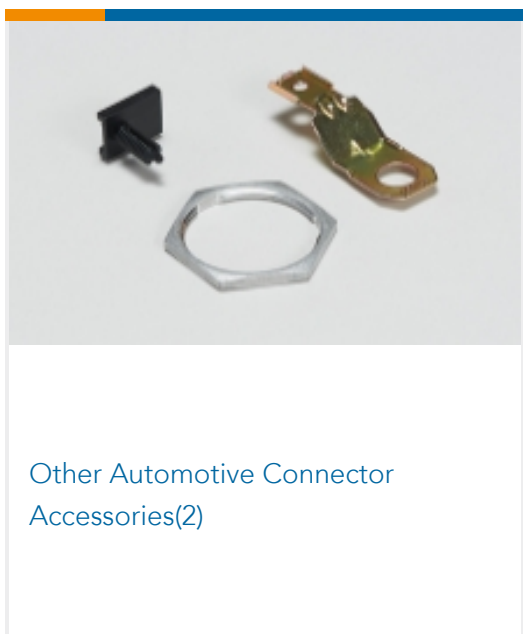
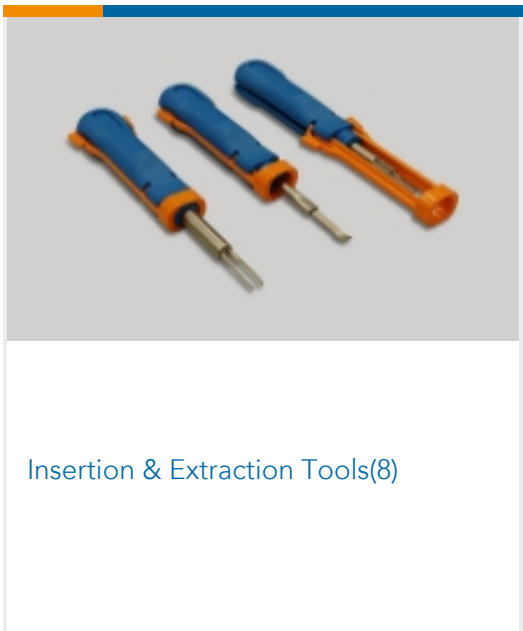
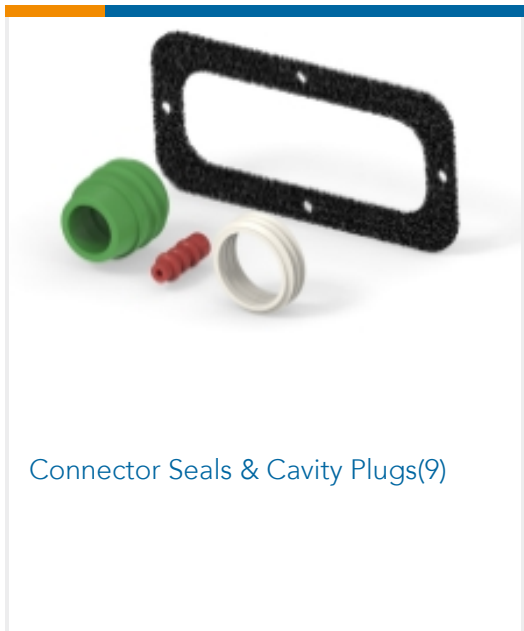
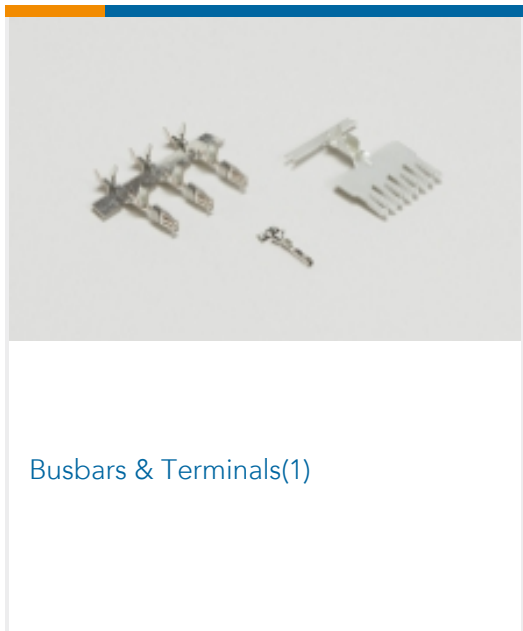
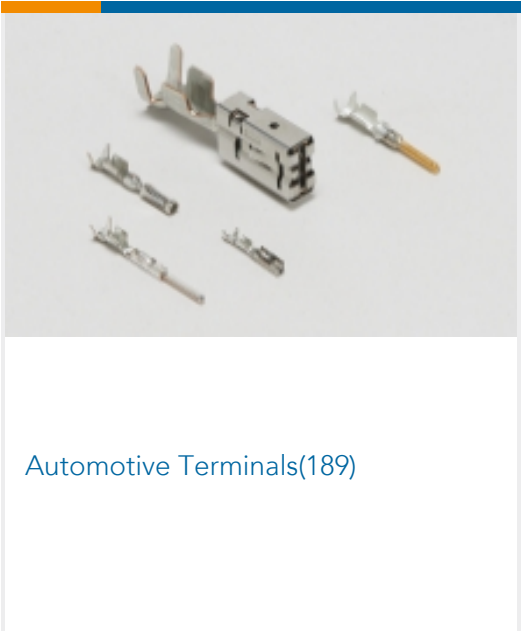
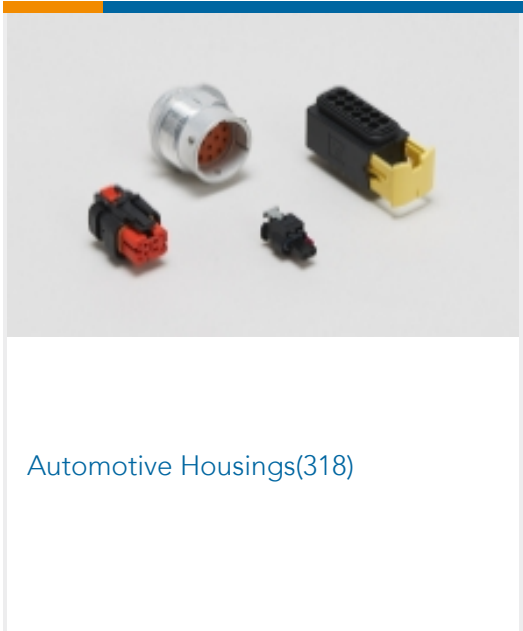
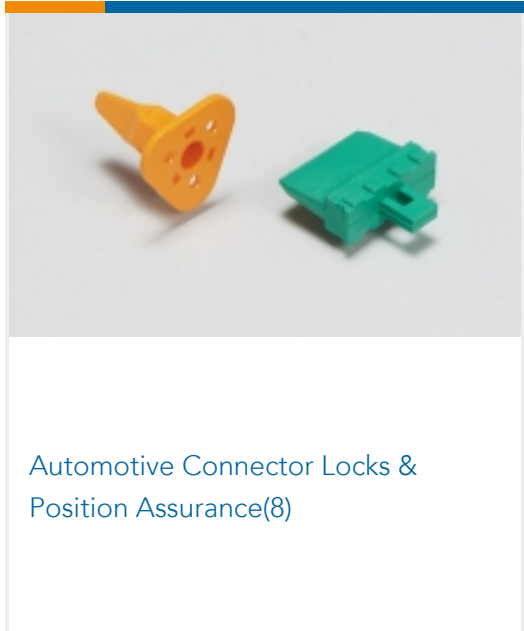
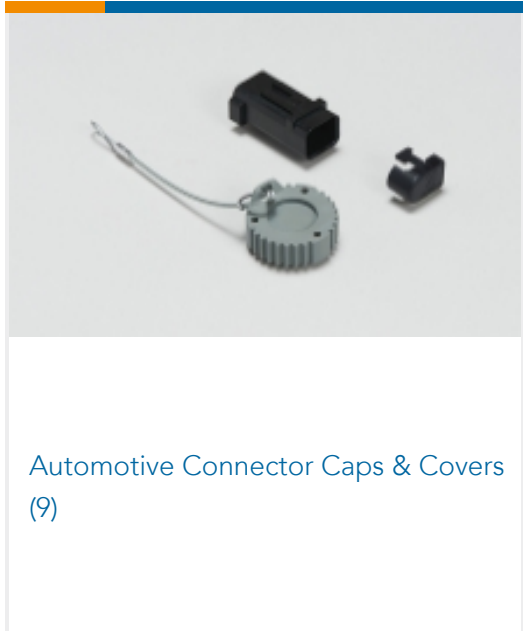

Also in the Series | Timer Connector System



Automotive Connector Caps & Covers (14)

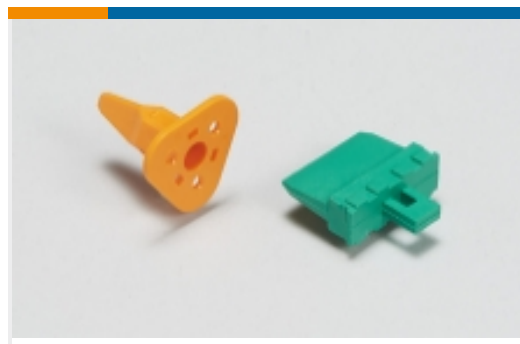

Automotive Connector Locks & Position Assurance(15)



Automotive Housings(209)



Automotive Terminals(135)



Connector Seals & Cavity Plugs(38)



Crimp Terminal Housings(13)



Insertion & Extraction Tools(18)



Other Automotive Connector Accessories(1)

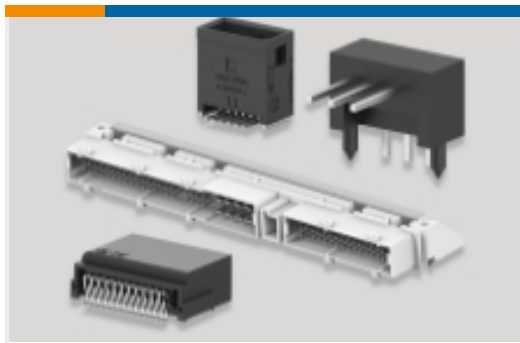

PCB Headers & Receptacles(40)



Quick Disconnects(4)

Customers Also Bought



TE Part #180984-5
FASTON 250 BOOT FLAG NYLON BLK



TE Part #5-1423364-8
W57-XB6A99C10-12=CKTBKR,THERM, PB,QC.250



TE Part #NB07596001
HTAT-24/6-0-150MM



TE Part #1801600-4
RECEPTACLE HOUSING, MCON, 10 W, SEALED



TE Part #1544966-2
8MM NG1+ TERMINAL



TE Part #1801176-5
2W RECEPTACLE HPSL CONNECTOR GREEN



TE Part #1801179-3
3W RECEPTACLE HPSL CONNECTOR GREY



TE Part #2819654-1
DT04-2P-RT01



Documents

Product Drawings

[JPT F REC 2.8 Contact SRC Sn](#)

English

CAD Files

[3D PDF](#)

3D

Customer View Model

[ENG_CVM_CVM_144432-1_N.2d_dxf.zip](#)

English

Customer View Model

[ENG_CVM_CVM_144432-1_N.3d_igs.zip](#)

English

Customer View Model

[ENG_CVM_CVM_144432-1_N.3d_stp.zip](#)

English

By downloading the CAD file I accept and agree to the [Terms and Conditions](#) of use.

Product Specifications

[Application Specification](#)

English