

## LISA4-W

~36° wide beam with integrated pins on lens

### SPECIFICATION:

Dimensions	Ø 10.0
Height	7.7 mm
Fastening	pin
ROHS compliant	yes ⓘ

### MATERIALS:

Component	Type	Material	Colour	Finish	Length (mm)
LISA4-W	Single lens	PMMA	clear		

### ORDERING INFORMATION:

Component	Qty in box	MOQ	MPQ	Box weight (kg)
C17523_LISA4-W » Box size: 430 x 390 x 215 mm	20000	1000	1000	7.5



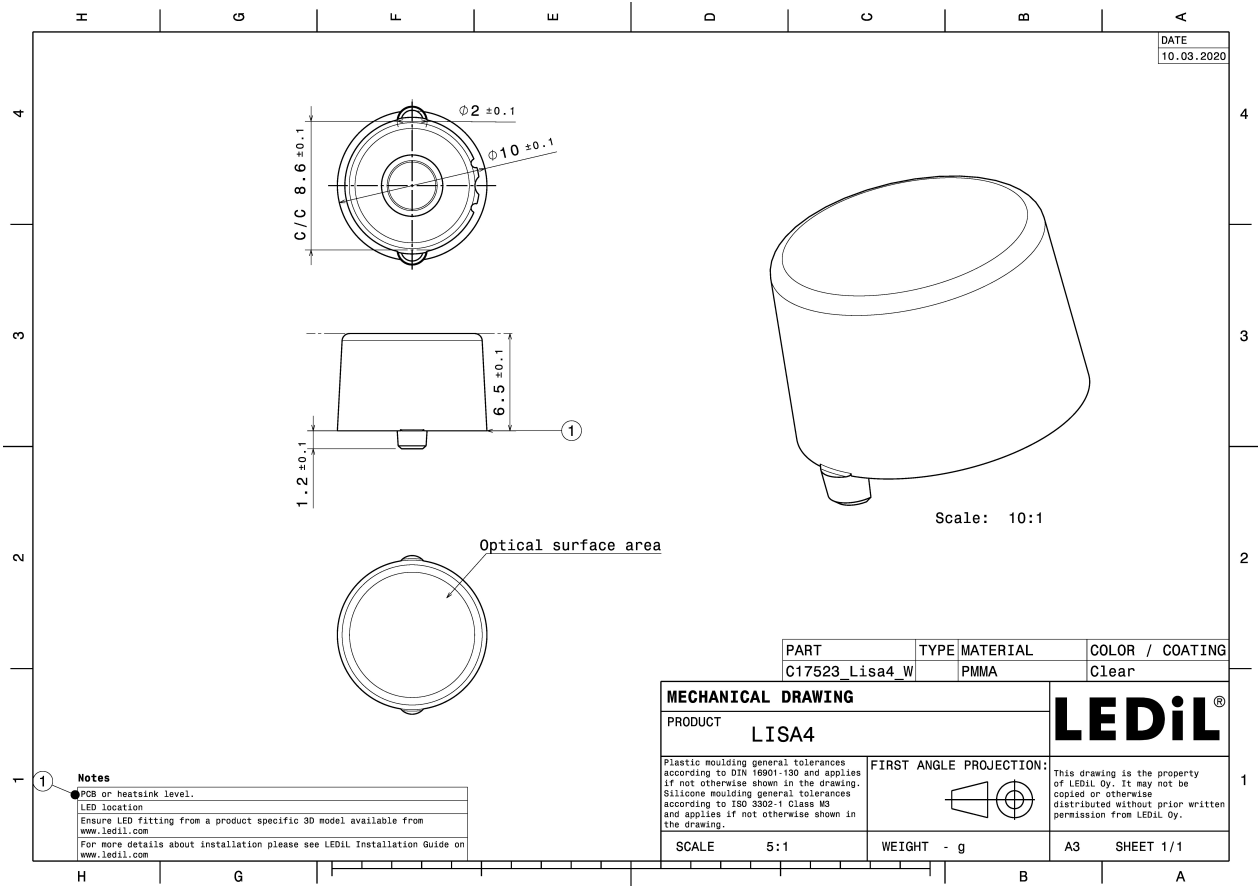

See also our general installation guide: [www.ledil.com/installation\\_guide](http://www.ledil.com/installation_guide)

### OPTICAL RESULTS (SIMULATED):



LED J Series 3030C  
 FWHM / FWTM 36.0° / 62.0°  
 Efficiency 96 %  
 Peak intensity 2.3 cd/lm  
 LEDs/each optic 1  
 Light colour/type White  
 Required components:

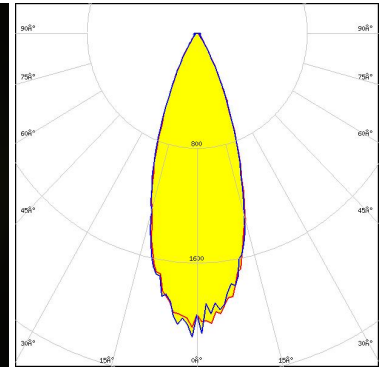

Light distribution files



LED XP-E2  
 FWHM / FWTM 36.0° / 61.0°  
 Efficiency 95 %  
 Peak intensity 2.1 cd/lm  
 LEDs/each optic 1  
 Light colour/type White  
 Required components:

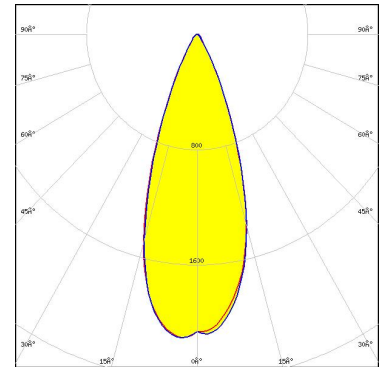

Light distribution files



LED XP-G2  
 FWHM / FWTM 38.0° / 64.0°  
 Efficiency 95 %  
 Peak intensity 1.8 cd/lm  
 LEDs/each optic 1  
 Light colour/type White  
 Required components:

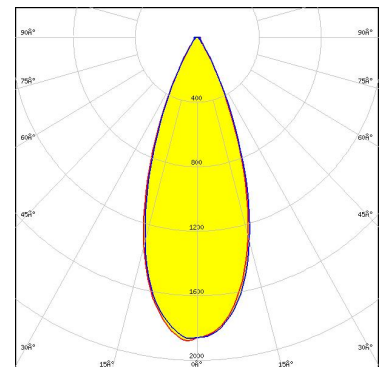

Light distribution files

### OPTICAL RESULTS (SIMULATED):



LED XP-G3  
FWHM / FWTM 45.0° / 76.0°  
Efficiency 95 %  
Peak intensity 1.4 cd/lm  
LEDs/each optic 1  
Light colour/type White  
Required components:

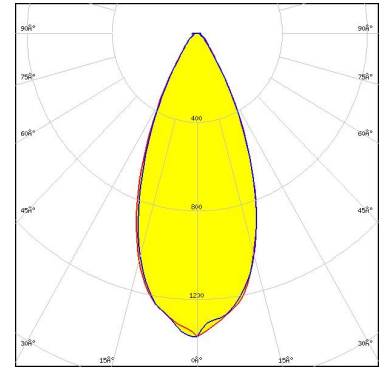

Light distribution files



LED LUXEON HL1Z  
FWHM / FWTM 26.0 + 25.0° / 48.0 + 47.0°  
Efficiency 97 %  
Peak intensity 3.5 cd/lm  
LEDs/each optic 1  
Light colour/type White  
Required components:

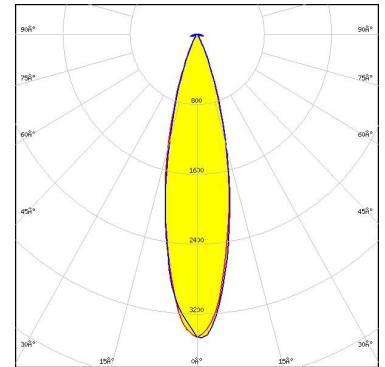

Light distribution files



LED LUXEON TX  
FWHM / FWTM 38.0° / 67.0°  
Efficiency 96 %  
Peak intensity 1.8 cd/lm  
LEDs/each optic 1  
Light colour/type White  
Required components:

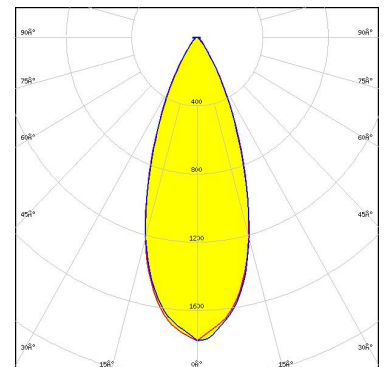

Light distribution files

### OPTICAL RESULTS (SIMULATED):



**LED** SFT-12R-WES  
**FWHM / FWTM** 32.0° / 55.0 + 54.0°  
**Efficiency** 96 %  
**Peak intensity** 2.8 cd/lm  
**LEDs/each optic** 1  
**Light colour/type** White  
**Required components:**

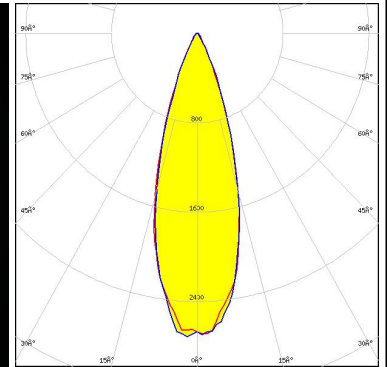
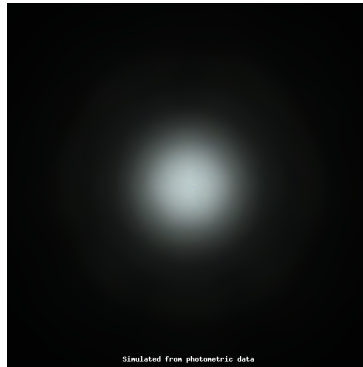

Light distribution files



**LED** SFT-25R  
**FWHM / FWTM** 33.0 + 32.0° / 57.0 + 56.0°  
**Efficiency** 96 %  
**Peak intensity** 2.6 cd/lm  
**LEDs/each optic** 1  
**Light colour/type** White  
**Required components:**

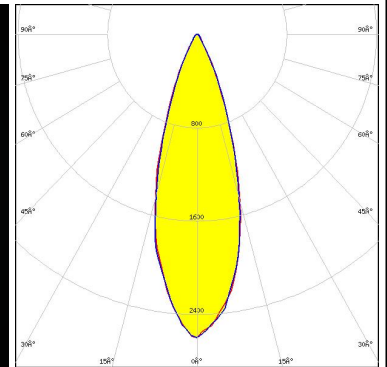
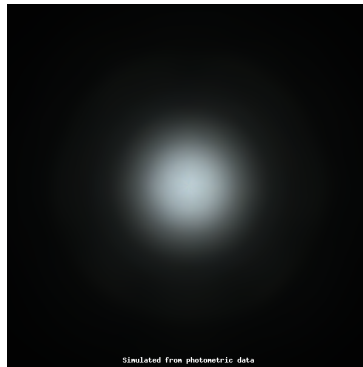

Light distribution files



**LED** SST-10-IR-B90  
**FWHM / FWTM** 33.0° / 55.0°  
**Efficiency** 93 %  
**LEDs/each optic** 1  
**Light colour/type** IR  
**Required components:**

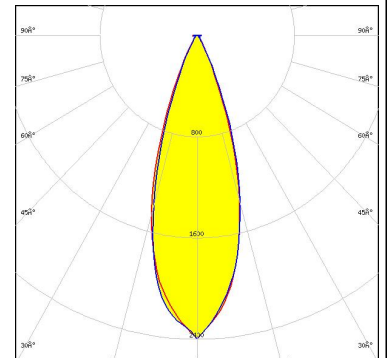
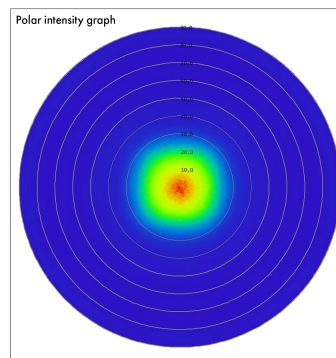

Light distribution files

### OPTICAL RESULTS (SIMULATED):



**LED** SST-12  
**FWHM / FWTM** 35.0 + 34.0° / 60.0°  
**Efficiency** 96 %  
**Peak intensity** 2.3 cd/lm  
**LEDs/each optic** 1  
**Light colour/type** White  
**Required components:**

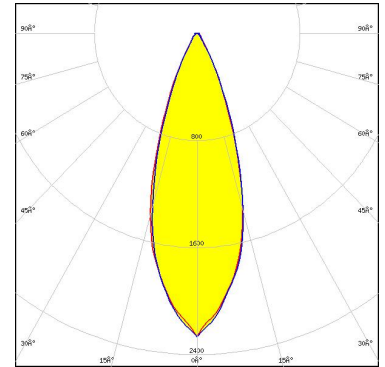

Light distribution files



**LED** SST-12 Gen2  
**FWHM / FWTM** 37.0 + 36.0° / 62.0°  
**Efficiency** 96 %  
**Peak intensity** 2.1 cd/lm  
**LEDs/each optic** 1  
**Light colour/type** White  
**Required components:**

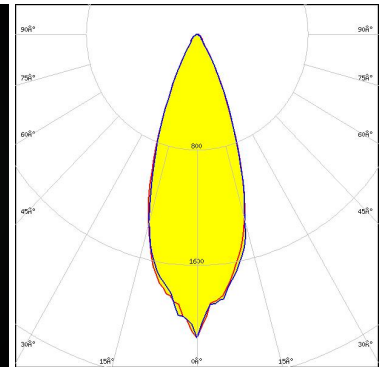
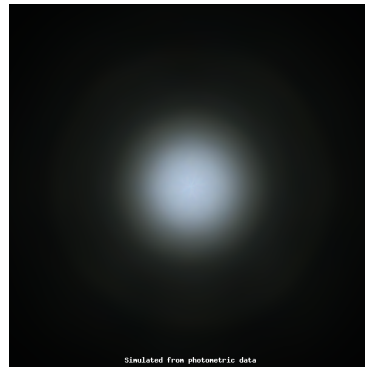

Light distribution files



**LED** SST-20 Gen2  
**FWHM / FWTM** 36.0° / 62.0°  
**Efficiency** 96 %  
**Peak intensity** 2.2 cd/lm  
**LEDs/each optic** 1  
**Light colour/type** White  
**Required components:**

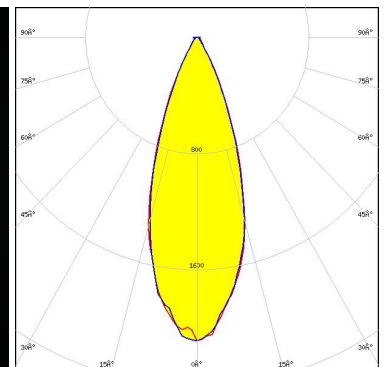

Light distribution files

### OPTICAL RESULTS (SIMULATED):



LED NCSxE17A  
 FWHM / FWTM 27.0° / 50.0°  
 Efficiency 95 %  
 Peak intensity 3 cd/lm  
 LEDs/each optic 1  
 Light colour/type White  
 Required components:

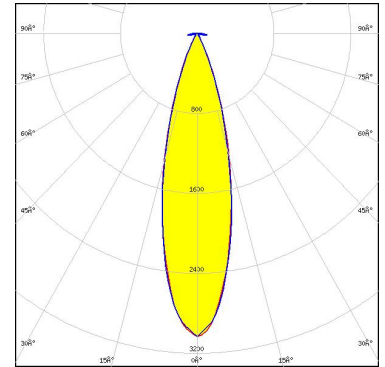

Light distribution files



LED NVSW219F  
 FWHM / FWTM 47.0° / 72.0°  
 Efficiency 93 %  
 Peak intensity 1.4 cd/lm  
 LEDs/each optic 1  
 Light colour/type White  
 Required components:

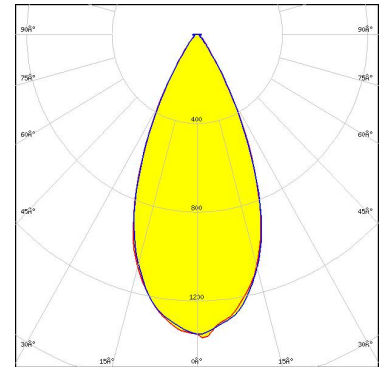

Light distribution files



LED Duris S5 (2 chip)  
 FWHM / FWTM 35.0° / 60.0°  
 Efficiency 95 %  
 Peak intensity 2.2 cd/lm  
 LEDs/each optic 1  
 Light colour/type White  
 Required components:

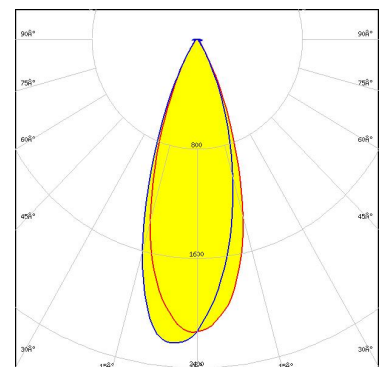

Light distribution files

### OPTICAL RESULTS (SIMULATED):

**OSRAM**  
Opto Semiconductors

LED Duris S5 (Single chip)  
FWHM / FWTM 30.0° / 56.0°  
Efficiency 95 %  
Peak intensity 2.7 cd/lm  
LEDs/each optic 1  
Light colour/type White  
Required components:

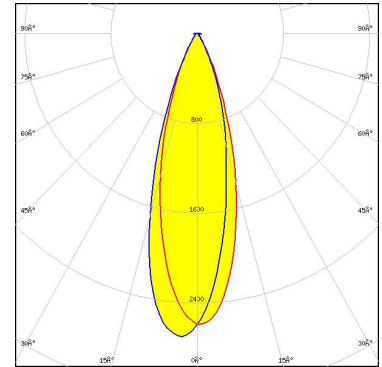

Light distribution files

**OSRAM**  
Opto Semiconductors

LED OSCONIQ C 2424  
FWHM / FWTM 33.0° / 57.0°  
Efficiency 96 %  
Peak intensity 2.6 cd/lm  
LEDs/each optic 1  
Light colour/type White  
Required components:

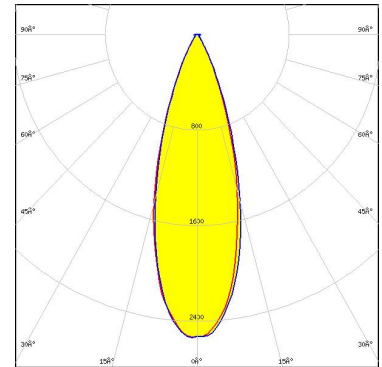

Light distribution files

**OSRAM**  
Opto Semiconductors

LED OSCONIQ P 3737 (3W version)  
FWHM / FWTM 45.0° / 72.0°  
Efficiency 96 %  
Peak intensity 1.5 cd/lm  
LEDs/each optic 1  
Light colour/type White  
Required components:

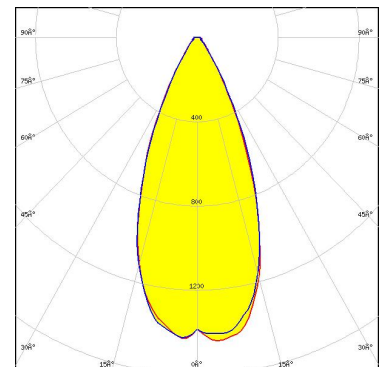

Light distribution files



### OPTICAL RESULTS (SIMULATED):

**OSRAM**  
Opto Semiconductors

LED OSCONIQ S 3030 (QSLR31)  
FWHM / FWTM 37.0° / 63.0°  
Efficiency 95 %  
Peak intensity 2.1 cd/lm  
LEDs/each optic 1  
Light colour/type White  
Required components:

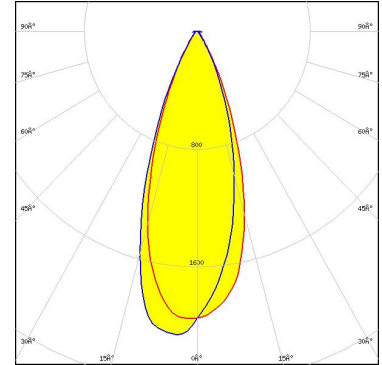

Light distribution files

**OSRAM**  
Opto Semiconductors

LED OSLO Pure 1414  
FWHM / FWTM 32.0° / 54.0°  
Efficiency 96 %  
Peak intensity 2.7 cd/lm  
LEDs/each optic 1  
Light colour/type White  
Required components:

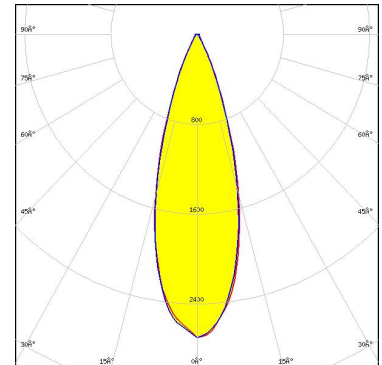

Light distribution files

**OSRAM**  
Opto Semiconductors

LED OSLO Signal  
FWHM / FWTM 42.0° / 66.0°  
Efficiency 94 %  
Peak intensity 1.7 cd/lm  
LEDs/each optic 1  
Light colour/type Red  
Required components:

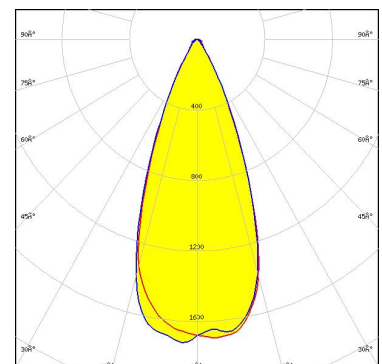

Light distribution files

### OPTICAL RESULTS (SIMULATED):

**OSRAM**  
Opto Semiconductors

LED OSLO Square CSSRM2/CSSRM3  
FWHM / FWTM 40.0° / 68.0°  
Efficiency 95 %  
Peak intensity 1.7 cd/lm  
LEDs/each optic 1  
Light colour/type White  
Required components:

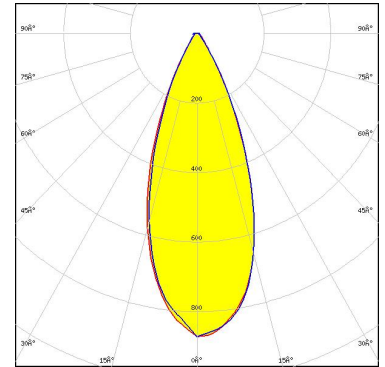

Light distribution files

**OSRAM**  
Opto Semiconductors

LED OSLO Square EC  
FWHM / FWTM 36.0° / 60.0°  
Efficiency 95 %  
Peak intensity 2 cd/lm  
LEDs/each optic 1  
Light colour/type White  
Required components:

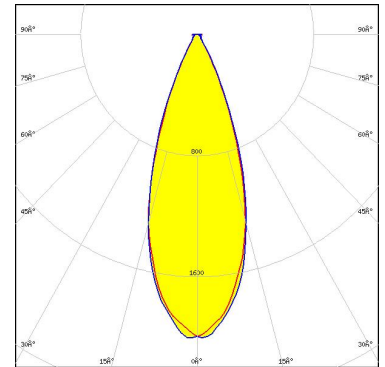

Light distribution files

**OSRAM**  
Opto Semiconductors

LED OSLO SSL 80  
FWHM / FWTM 29.0° / 53.0°  
Efficiency 95 %  
Peak intensity 2.9 cd/lm  
LEDs/each optic 1  
Light colour/type White  
Required components:

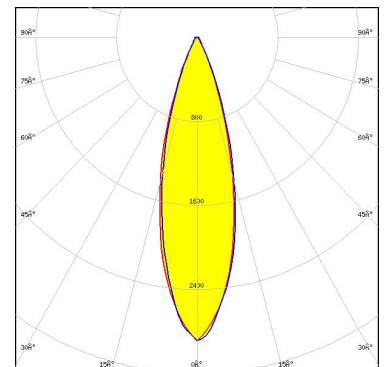

Light distribution files

### OPTICAL RESULTS (SIMULATED):

#### SAMSUNG

LED	LH351B
FWHM / FWTM	42.0° / 70.0°
Efficiency	95 %
Peak intensity	1.8 cd/lm
LEDs/each optic	1
Light colour/type	White
Required components:	

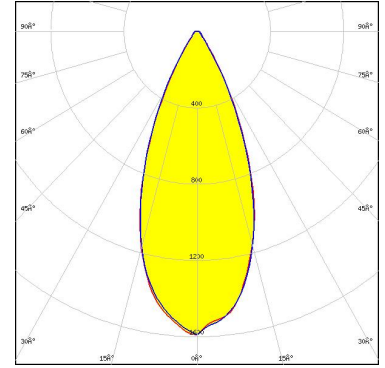

Light distribution files

### GENERAL INFORMATION:

NOTE: The typical beam angle will be changed by different color, chip size and chip position tolerance. The typical total beam angle is the full angle measured where the luminous intensity is half of the peak value.

### MATERIALS:

As part of our continuous research and improvement processes, and to ensure the best possible quality and availability of our products, LEDiL reserves the right to change material grades without notice.

### PRODUCT DATA USER AGREEMENT AND DISCLAIMER:

The measured data in the provided downloadable LEDiL Product Datasheets and Mechanical 2D-Drawings is rounded and provided as reference for planning. LEDiL Oy's optical specifications have been verified by conducting performance testing of the products in accordance with the company's quality system. The reported data are averaged results of multiple measurements with typical variation. LEDiL Oy reserves the right to without prior notification make changes and improvements to its products.

LEDiL Oy assumes neither warranty, nor guarantee nor any other liability of any kind for the contents and correctness of the provided data. The provided data has been generated with highest diligence but the provided data may in reality not represent the complete possible variation range of all intrinsic parameters. Therefore, in certain cases a deviation from the provided data could occur.

LEDiL Oy reserves the right to undertake technical changes of its products without further notification which could lead to changes in the provided data. LEDiL Oy assumes no liability of any kind for the possible deviation from any provided data or any other damage resulting from the usage of the provided data.

The user agrees to this disclaimer and user agreement with the download or usage of the provided files.

#### LEDiL Oy

Joensuunkatu 13  
FI-24240 SALO  
Finland

#### LEDiL Inc.

228 West Page Street  
Suite D  
Sycamore IL 60178  
USA

#### Ledil Optics Technology (Shenzhen) Co., Ltd.

# 405 , Block B  
Casic Motor Building  
Shenzhen 518057  
P.R.CHINA

#### Local sales and technical support

[www.ledil.com/  
where\\_to\\_buy](http://www.ledil.com/where_to_buy)

#### Shipping locations

Poznan, Poland  
Hong Kong, China

#### Distribution Partners

[www.ledil.com/  
where\\_to\\_buy](http://www.ledil.com/where_to_buy)