



# SGM8212-1/SGM8212-2

## Low Noise, High Voltage Operational Amplifiers

### GENERAL DESCRIPTION

The single SGM8212-1 and dual SGM8212-2 are low noise operational amplifiers optimized for high voltage operation from 2.7V to 36V single supply or  $\pm 1.35V$  to  $\pm 18V$  dual power supplies. These devices consume low quiescent current. They provide rail-to-rail input with a wide input common mode voltage range from  $(-V_S) - 0.1V$  to  $(+V_S) + 0.1V$ , and rail-to-rail output voltage swing. However, the performance is reduced within 2V of the top rail.

The SGM8212-1/2 also feature low offset voltage and high gain-bandwidth product.

The SGM8212-1 is available in Green SOT-553-5, SOT-23-5 and SOIC-8 packages. The SGM8212-2 is available in Green SOIC-8 and TDFN-3x3-8L packages. They are specified over the extended  $-40^{\circ}C$  to  $+125^{\circ}C$  temperature range.

### FEATURES

- **Input Offset Voltage: 1.8mV (MAX)**
- **Low Input Bias Current: 5pA (TYP)**
- **High CMRR: 98dB (TYP)**
- **Unity-Gain Stable**
- **Gain-Bandwidth Product: 2.5MHz**
- **Phase Margin: 60° for  $G = 1$  and  $C_L = 10pF$**
- **Low Noise:  $15nV/\sqrt{Hz}$  at 1kHz**
- **Rail-to-Rail Input and Output**
- **Support Single or Dual Power Supplies: 2.7V to 36V or  $\pm 1.35V$  to  $\pm 18V$**
- **Low Quiescent Current: 475 $\mu$ A/Amplifier**
- **$-40^{\circ}C$  to  $+125^{\circ}C$  Operating Temperature Range**
- **Small Packaging:**
  - **SGM8212-1 Available in Green SOT-553-5, SOT-23-5 and SOIC-8 Packages**
  - **SGM8212-2 Available in Green SOIC-8 and TDFN-3x3-8L Packages**

### APPLICATIONS

Battery-Powered Instrumentation  
Test Equipment  
Strain Gauge Amplifiers  
Bridge Amplifiers  
Transducer Amplifiers  
Tracking Amplifiers in Power Modules  
Precision Integrators  
Merchant Power Supplies  
Temperature Measurements

**PACKAGE/ORDERING INFORMATION**

MODEL	PACKAGE DESCRIPTION	SPECIFIED TEMPERATURE RANGE	ORDERING NUMBER	PACKAGE MARKING	PACKING OPTION
SGM8212-1	SOT-553-5	-40°C to +125°C	SGM8212-1XKB5G/TR	MFY	Tape and Reel, 4000
	SOT-23-5	-40°C to +125°C	SGM8212-1XN5G/TR	R12XX	Tape and Reel, 3000
	SOIC-8	-40°C to +125°C	SGM8212-1XS8G/TR	SGM 82121XS8 XXXXX	Tape and Reel, 4000
SGM8212-2	SOIC-8	-40°C to +125°C	SGM8212-2XS8G/TR	SGM 82122XS8 XXXXX	Tape and Reel, 4000
	TDFN-3×3-8L	-40°C to +125°C	SGM8212-2XTDB8G/TR	SGM 82122DB XXXXX	Tape and Reel, 4000

**MARKING INFORMATION**

NOTE: X = Date Code. XX = Date Code. XXXXX = Date Code, Trace Code and Vendor Code.

**SOT-553-5**

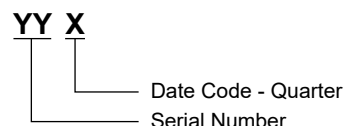

**SOT-23-5**

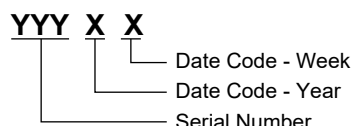

**SOIC-8/TDFN-3×3-8L**

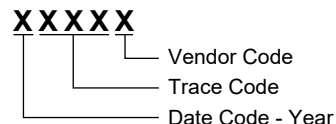

Green (RoHS & HSF): SG Micro Corp defines "Green" to mean Pb-Free (RoHS compatible) and free of halogen substances. If you have additional comments or questions, please contact your SGMICRO representative directly.

**ABSOLUTE MAXIMUM RATINGS**

- Supply Voltage, +V<sub>S</sub> to -V<sub>S</sub>..... 40V
- Input/Output Voltage Range..... (-V<sub>S</sub>) - 0.3V to (+V<sub>S</sub>) + 0.3V
- Junction Temperature .....+150°C
- Storage Temperature Range.....-65°C to +150°C
- Lead Temperature (Soldering, 10s) .....+260°C
- ESD Susceptibility
- HBM (SGM8212-1) ..... 2500V
- HBM (SGM8212-2) ..... 4000V
- CDM ..... 1000V

**RECOMMENDED OPERATING CONDITIONS**

- Operating Temperature Range .....-40°C to +125°C

**OVERSTRESS CAUTION**

Stresses beyond those listed in Absolute Maximum Ratings may cause permanent damage to the device. Exposure to absolute maximum rating conditions for extended periods

may affect reliability. Functional operation of the device at any conditions beyond those indicated in the Recommended Operating Conditions section is not implied.

**ESD SENSITIVITY CAUTION**

This integrated circuit can be damaged if ESD protections are not considered carefully. SGMICRO recommends that all integrated circuits be handled with appropriate precautions. Failure to observe proper handling and installation procedures can cause damage. ESD damage can range from subtle performance degradation to complete device failure. Precision integrated circuits may be more susceptible to damage because even small parametric changes could cause the device not to meet the published specifications.

**DISCLAIMER**

SG Micro Corp reserves the right to make any change in circuit design, or specifications without prior notice.

**PIN CONFIGURATIONS**

**SGM8212-1 (TOP VIEW)**

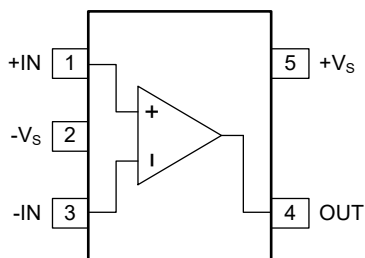

**SOT-553-5**

**SGM8212-1 (TOP VIEW)**

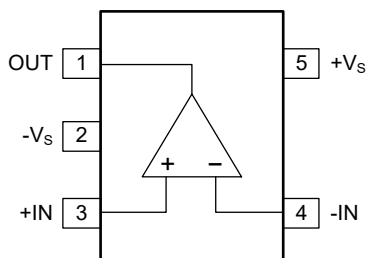

**SOT-23-5**

**SGM8212-1 (TOP VIEW)**

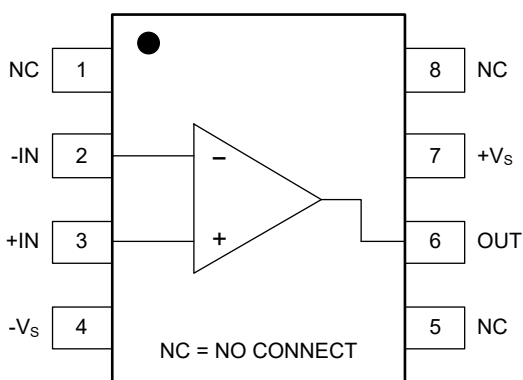

**SOIC-8**

**SGM8212-2 (TOP VIEW)**

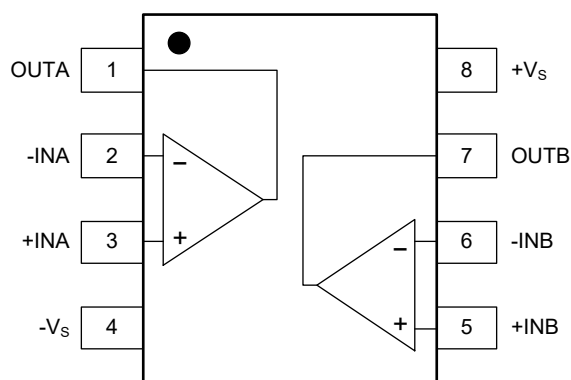

**SOIC-8**

**SGM8212-2 (TOP VIEW)**

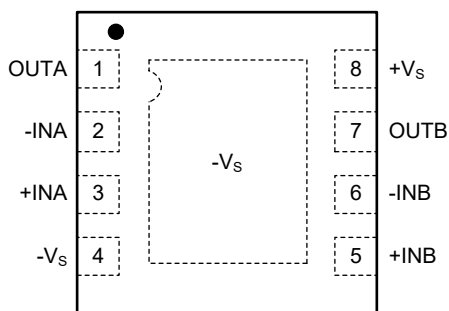

**TDFN-3x3-8L**

NOTE: For the TDFN-3x3-8L package, exposed pad can be connected to  $-V_s$  or left floating.

**ELECTRICAL CHARACTERISTICS**

(At  $T_A = +25^\circ\text{C}$ ,  $V_S = \pm 1.35\text{V}$  to  $\pm 18\text{V}$ ,  $R_L = 10\text{k}\Omega$  connected to  $0\text{V}$ , Full =  $-40^\circ\text{C}$  to  $+125^\circ\text{C}$ , unless otherwise noted.)

PARAMETER	SYMBOL	CONDITIONS	TEMP	MIN	TYP	MAX	UNITS
<b>Input Characteristics</b>							
Input Offset Voltage	$V_{OS}$	$V_{CM} = 0\text{V}$	+25°C		0.4	1.8	mV
			Full			2	
Input Offset Voltage Drift	$\Delta V_{OS}/\Delta T$		Full		1.1		$\mu\text{V}/^\circ\text{C}$
Input Bias Current	$I_B$	$V_{CM} = 0\text{V}$	+25°C		$\pm 5$	$\pm 120$	pA
Input Offset Current	$I_{OS}$	$V_{CM} = 0\text{V}$	+25°C		$\pm 5$	$\pm 120$	pA
Maximum Differential Input Voltage	$ V_{ID} $		Full			$V_S$	V
Maximum Input Difference Bias Current	$ I_{ID} $	$V_S = \pm 18\text{V}$ , $V_{ID} = \pm 18\text{V}$	+25°C		2	3	$\mu\text{A}$
			Full			4	
Input Common Mode Voltage Range	$V_{CM}$		Full	$(-V_S) - 0.1$		$(+V_S) + 0.1$	V
Common Mode Rejection Ratio	CMRR	$V_S = \pm 2\text{V}$ , $(-V_S) - 0.1\text{V} < V_{CM} < (+V_S) + 0.1\text{V}$	+25°C	63	80		dB
			Full	60			
		$V_S = \pm 2\text{V}$ , $(-V_S) - 0.1\text{V} < V_{CM} < (+V_S) - 2\text{V}$	+25°C	78	94		
			Full	75			
		$V_S = \pm 18\text{V}$ , $(-V_S) - 0.1\text{V} < V_{CM} < (+V_S) + 0.1\text{V}$	+25°C	83	98		
			Full	80			
		$V_S = \pm 18\text{V}$ , $(-V_S) - 0.1\text{V} < V_{CM} < (+V_S) - 2\text{V}$	+25°C	100	115		
			Full	97			
Open-Loop Voltage Gain	$A_{OL}$	$V_S = \pm 2\text{V}$ , $(-V_S) + 0.35\text{V} < V_{OUT} < (+V_S) - 0.35\text{V}$	+25°C	103	130		dB
			Full	100			
		$V_S = \pm 18\text{V}$ , $(-V_S) + 0.35\text{V} < V_{OUT} < (+V_S) - 0.35\text{V}$	+25°C	123	140		
			Full	120			
<b>Output Characteristics</b>							
Output Voltage Swing from Rail	$V_{OUT}$	$V_S = \pm 18\text{V}$	+25°C		110	150	mV
			Full			240	
Output Short-Circuit Current	$I_{SC}$	$V_S = \pm 18\text{V}$	+25°C	$\pm 16$	$\pm 30$		mA
<b>Power Supply</b>							
Operating Voltage Range	$V_S$		Full	2.7		36	V
Quiescent Current/Amplifier	$I_Q$	$I_{OUT} = 0\text{A}$	+25°C		475	600	$\mu\text{A}$
			Full			680	
Power Supply Rejection Ratio	PSRR	$V_S = 4\text{V}$ to $36\text{V}$	+25°C	103	120		dB
			Full	100			

**ELECTRICAL CHARACTERISTICS (continued)**

(At  $T_A = +25^\circ\text{C}$ ,  $V_S = \pm 1.35\text{V}$  to  $\pm 18\text{V}$ ,  $R_L = 10\text{k}\Omega$  connected to  $0\text{V}$ , Full =  $-40^\circ\text{C}$  to  $+125^\circ\text{C}$ , unless otherwise noted.)

PARAMETER	SYMBOL	CONDITIONS	TEMP	MIN	TYP	MAX	UNITS
<b>Dynamic Performance</b>							
Gain-Bandwidth Product	GBP	$C_L = 10\text{pF}$	$+25^\circ\text{C}$		2.5		MHz
Phase Margin	$\phi_o$	$C_L = 10\text{pF}$	$+25^\circ\text{C}$		60		°
Slew Rate	SR	$V_S = \pm 2\text{V}$ to $\pm 18\text{V}$ , $G = +1$	$+25^\circ\text{C}$		1.5		$\text{V}/\mu\text{s}$
Settling Time to 0.1%	$t_s$	$V_S = \pm 18\text{V}$ , $G = +1$ , 10V step	$+25^\circ\text{C}$		15		$\mu\text{s}$
Overload Recovery Time	ORT	$V_{IN} \times G > V_S$	$+25^\circ\text{C}$		2		$\mu\text{s}$
Total Harmonic Distortion + Noise	THD+N	$V_S = 36\text{V}$ , $V_{OUT} = 3V_{RMS}$ , $f = 1\text{kHz}$ , $G = +1$	$+25^\circ\text{C}$		0.0002		%
<b>Noise</b>							
Input Voltage Noise		$f = 0.1\text{Hz}$ to $10\text{Hz}$	$+25^\circ\text{C}$		2.5		$\mu\text{V}_{P-P}$
Input Voltage Noise Density	$e_n$	$f = 100\text{Hz}$	$+25^\circ\text{C}$		25		$\text{nV}/\sqrt{\text{Hz}}$
		$f = 1\text{kHz}$	$+25^\circ\text{C}$		15		
Input Current Noise Density	$i_n$	$f = 1\text{kHz}$	$+25^\circ\text{C}$		300		$\text{fA}/\sqrt{\text{Hz}}$

**TYPICAL PERFORMANCE CHARACTERISTICS**

At  $T_A = +25^\circ\text{C}$ ,  $V_S = \pm 18\text{V}$ ,  $R_L = 10\text{k}\Omega$ , unless otherwise noted.

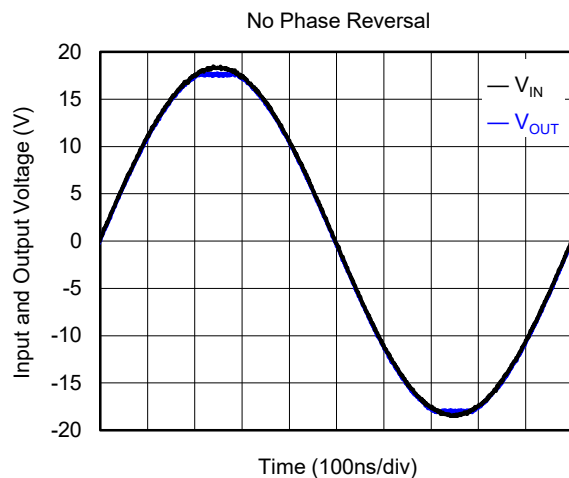
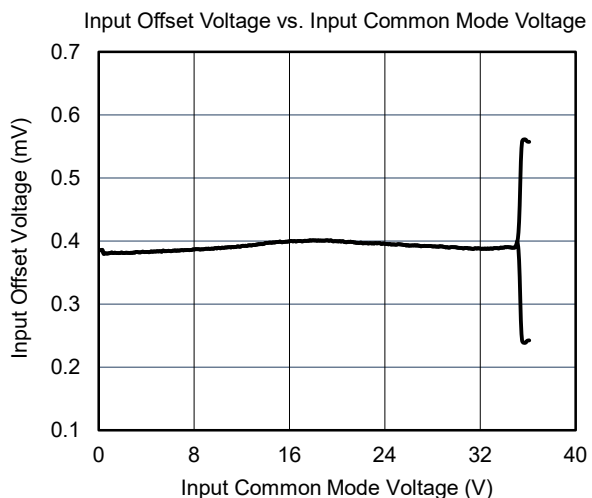
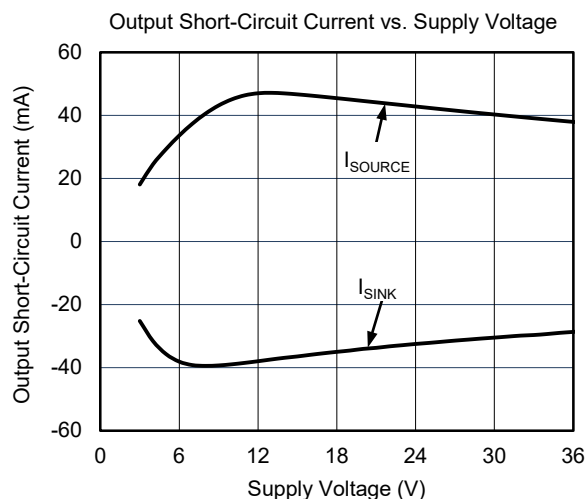
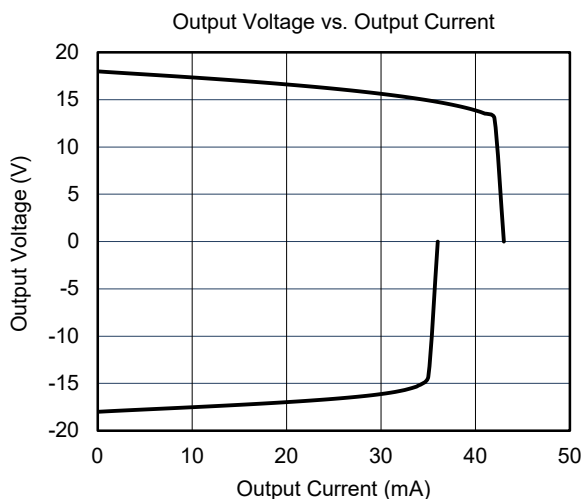
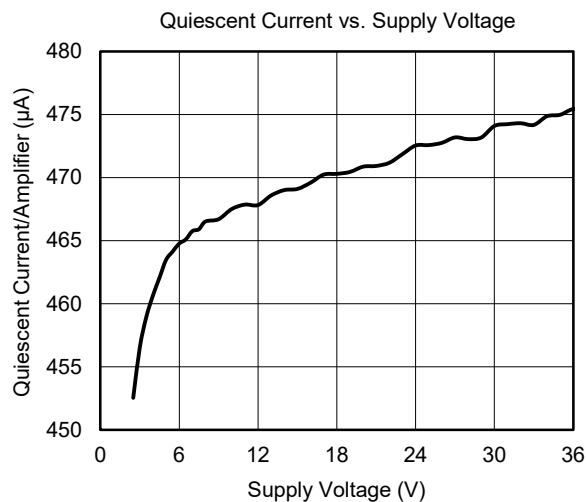
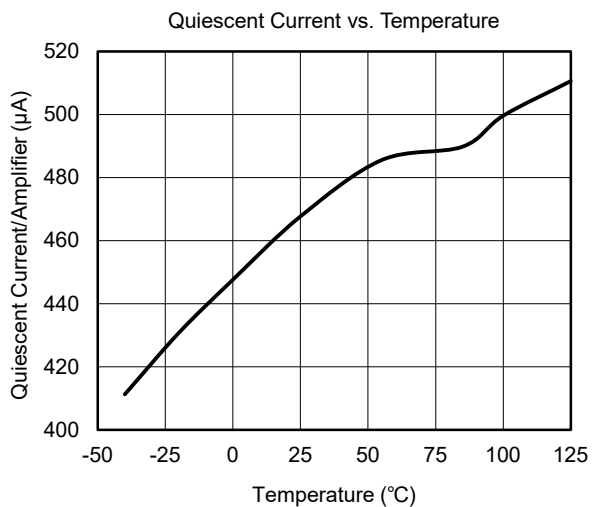

**TYPICAL PERFORMANCE CHARACTERISTICS (continued)**

At  $T_A = +25^\circ\text{C}$ ,  $V_S = \pm 18\text{V}$ ,  $R_L = 10\text{k}\Omega$ , unless otherwise noted.

Small-Signal Step Response

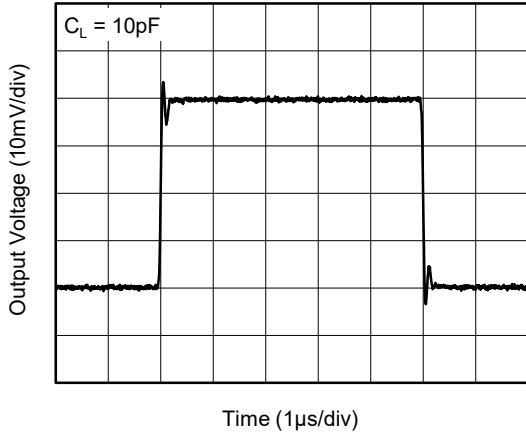

Large-Signal Step Response

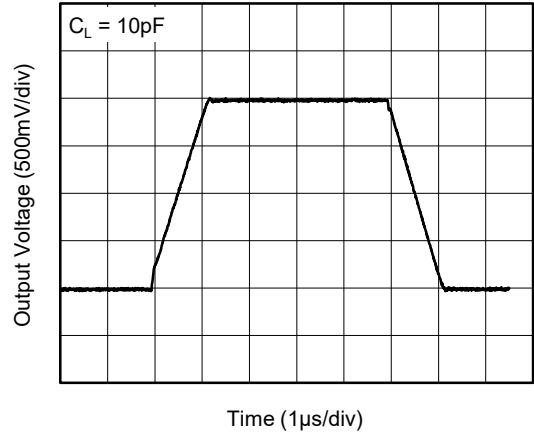

0.1Hz to 10Hz Input Voltage Noise

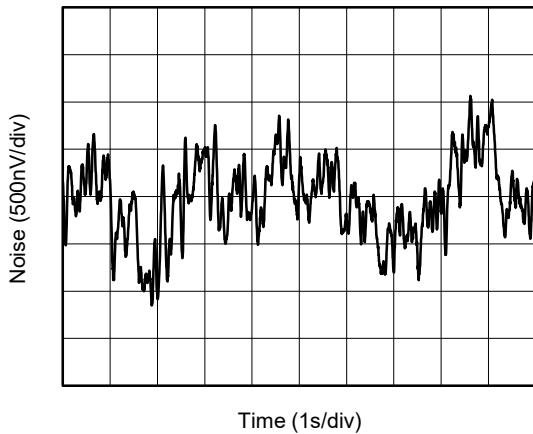

Input Voltage Noise Density vs. Frequency

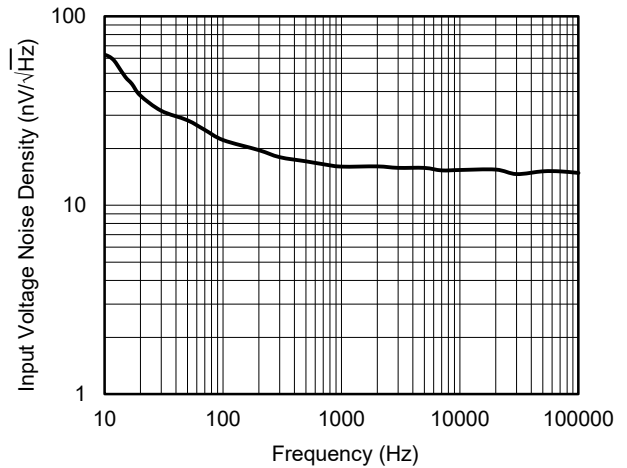

Small-Signal Overshoot vs. Capacitive Load

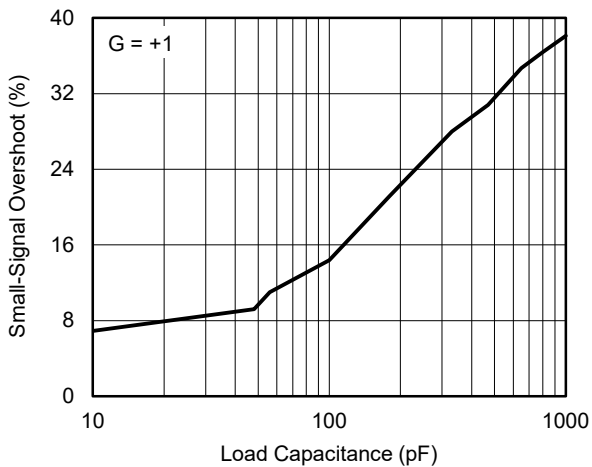

Open-Loop Gain and Phase vs. Frequency

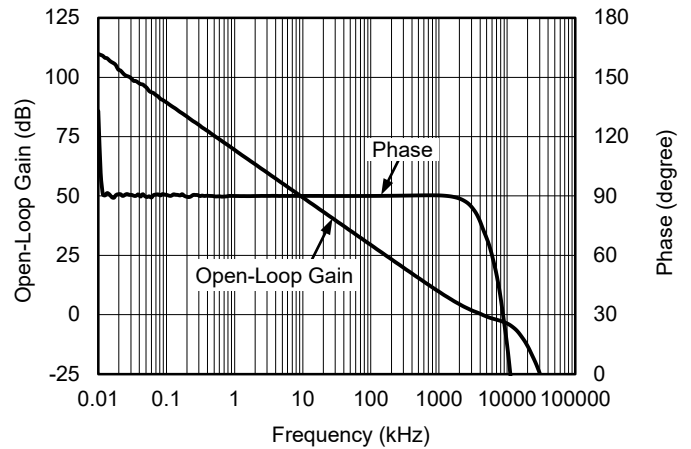

**TYPICAL PERFORMANCE CHARACTERISTICS (continued)**

At  $T_A = +25^\circ\text{C}$ ,  $V_S = \pm 18\text{V}$ ,  $R_L = 10\text{k}\Omega$ , unless otherwise noted.

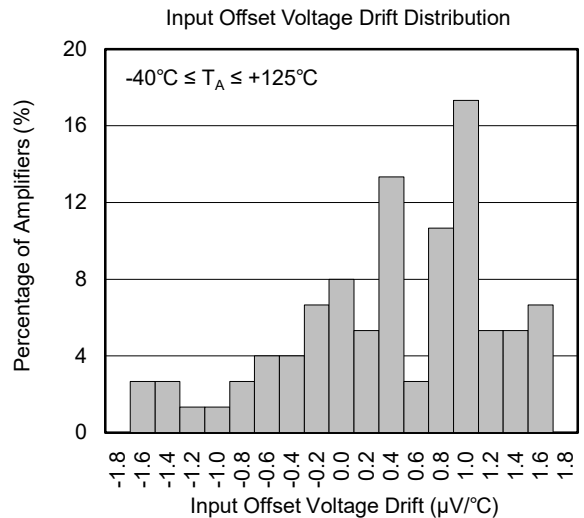
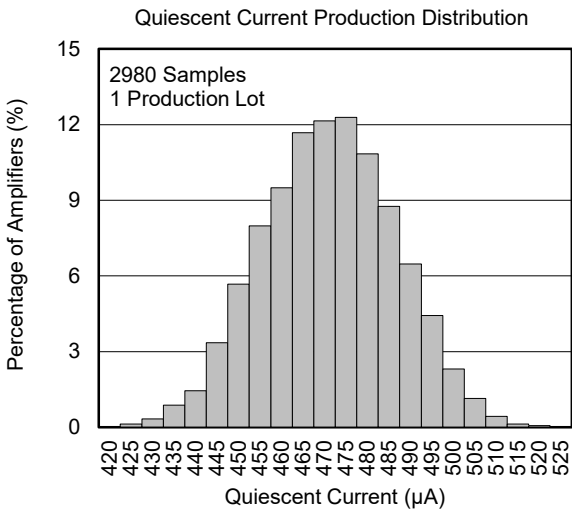
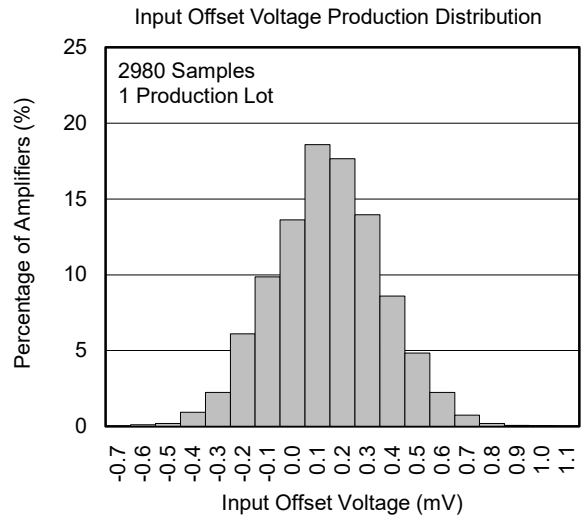
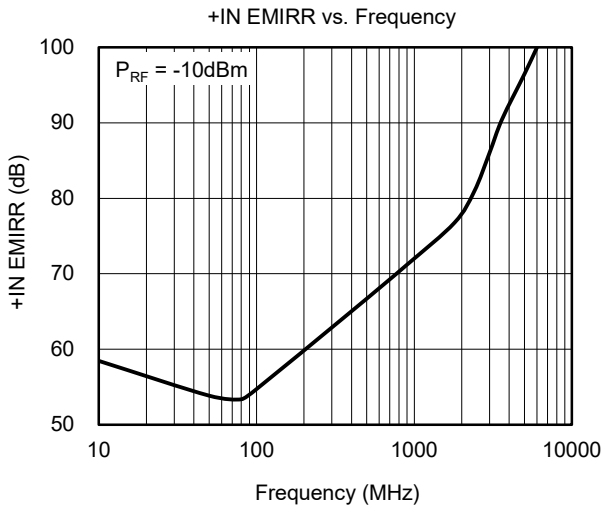
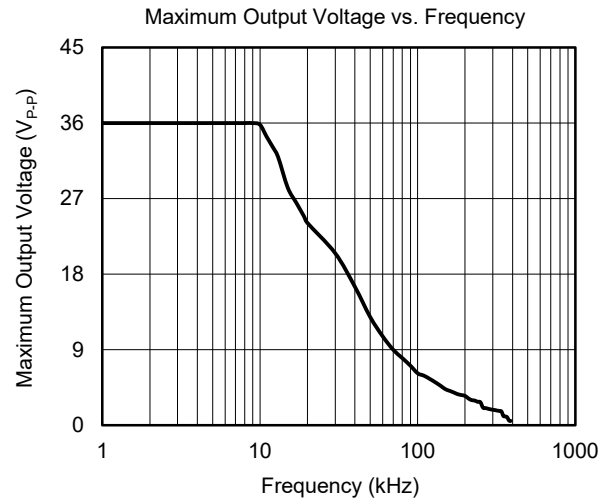
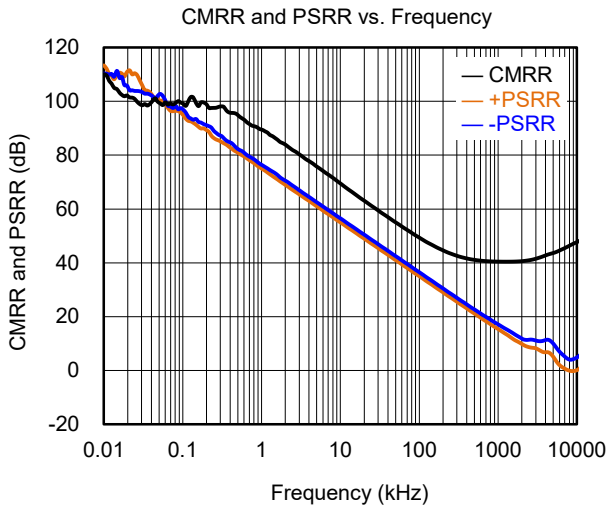



**APPLICATION INFORMATION**

**Rail-to-Rail Input**

When SGM8212-1/2 work at the power supply between 2.7V and 36V, the input common mode voltage range is from  $(-V_S) - 0.1V$  to  $(+V_S) + 0.1V$ . In Figure 1, the ESD diodes between the inputs and the power supply rails will clamp the input voltage not to exceed the rails.

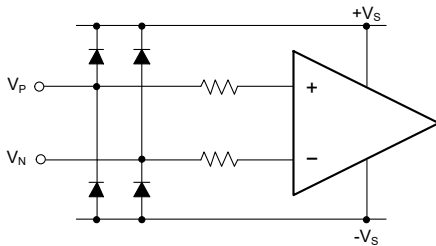

**Figure 1. Input Equivalent Circuit**

**Input Current-Limit Protection**

For ESD diode clamping protection, when the current flowing through ESD diode exceeds the maximum rating value, the ESD diode and amplifier will be damaged, so current-limit protection will be added in some applications. One resistor is selected to limit the current not to exceed the maximum rating value. In Figure 2, a series input resistor is used to limit the input current to less than 10mA, but the drawback of this current-limit resistor is that it contributes thermal noise at the amplifier input. If this resistor must be added, its value must be selected as small as possible.

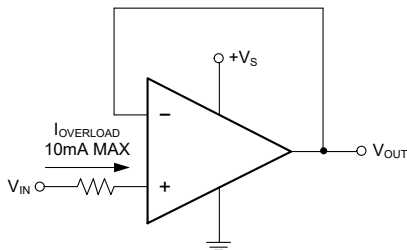

**Figure 2. Input Current-Limit Protection**

**Rail-to-Rail Output**

The SGM8212-1/2 support rail-to-rail output operation. In single power supply application, for example, when  $+V_S = 36V$ ,  $-V_S = GND$ , 10kΩ load resistor is tied from OUT pin to ground, the typical output swing range is from 0.11V to 35.89V.

**Driving Capacitive Loads**

The SGM8212-1/2 are designed for unity-gain stable for capacitive load up to 300pF. If greater capacitive load must be driven in application, the circuit in Figure 3 can be used. In this circuit, the IR drop voltage generated by  $R_{ISO}$  is compensated by feedback loop.

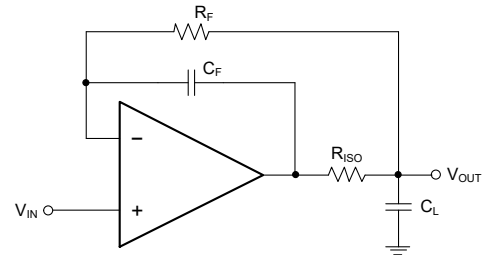

**Figure 3. Circuit to Drive Heavy Capacitive Load**

**Power Supply Decoupling and Layout**

A clean and low noise power supply is very important in amplifier circuit design, besides of input signal noise, the power supply is one of important source of noise to the amplifiers through  $+V_S$  and  $-V_S$  pins. Power supply bypassing is an effective method to clear up the noise at power supply, and the low impedance path to ground of decoupling capacitor will bypass the noise to GND. In application, 10μF ceramic capacitor paralleled with 0.1μF or 0.01μF ceramic capacitor is used in Figure 4. The ceramic capacitors should be placed as close as possible to  $+V_S$  and  $-V_S$  power supply pins.

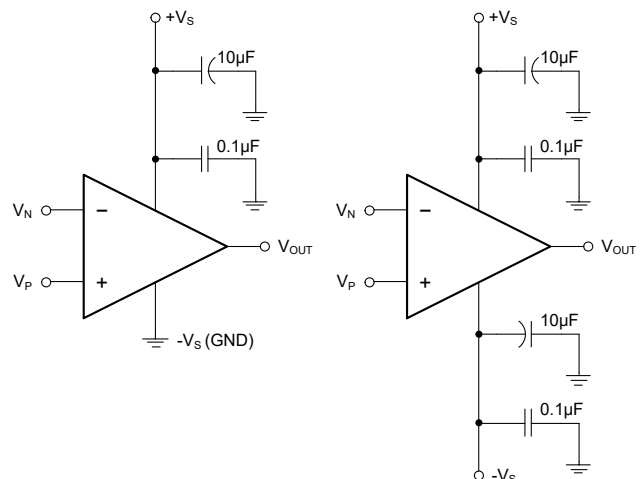

**Figure 4. Amplifier Power Supply Bypassing**

**APPLICATION INFORMATION (continued)**

**Grounding**

In low speed application, one node grounding technique is the simplest and most effective method to eliminate the noise generated by grounding. In high speed application, the general method to eliminate noise is to use a complete ground plane technique, and the whole ground plane will help distribute heat and reduce EMI noise pickup.

**Reduce Input-to-Output Coupling**

To reduce the input-to-output coupling, the input traces must be placed as far away from the power supply or output traces as possible. The sensitive trace must not be placed in parallel with the noisy trace in same layer. They must be placed perpendicularly in different layers to reduce the crosstalk. These PCB layout techniques will help to reduce unwanted positive feedback and noise.

**Typical Application Circuits**

**Difference Amplifier**

The circuit in Figure 5 is a design example of classical difference amplifier. If  $R_4/R_3 = R_2/R_1$ , then  $V_{OUT} = (V_P - V_N) \times R_2/R_1 + V_{REF}$ .

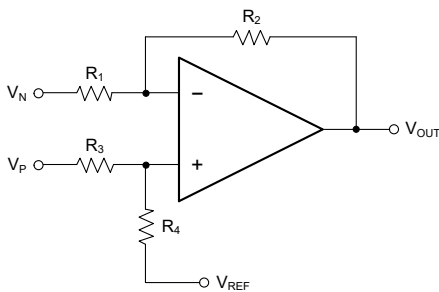

Figure 5. Difference Amplifier

**High Input Impedance Difference Amplifier**

The circuit in Figure 6 is a design example of high input impedance difference amplifier, the added amplifiers at

the input are used to increase the input impedance and eliminate drawback of low input impedance in Figure 5.

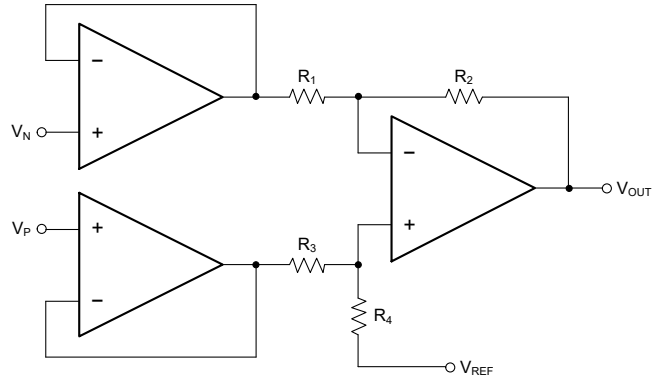

Figure 6. High Input Impedance Difference Amplifier

**Active Low-Pass Filter**

The circuit in Figure 7 is a design example of active low-pass filter, the DC gain is equal to  $-R_2/R_1$  and the  $-3\text{dB}$  corner frequency is equal to  $1/2\pi R_2 C$ . In this design, the filter bandwidth must be less than the bandwidth of the amplifier, the resistor values must be selected as low as possible to reduce ringing or oscillation generated by the parasitic parameters in PCB layout.

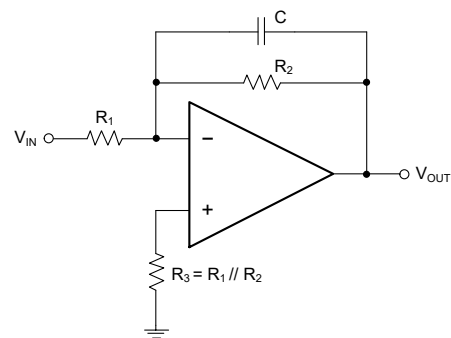

Figure 7. Active Low-Pass Filter

**REVISION HISTORY**

NOTE: Page numbers for previous revisions may differ from page numbers in the current version.

**Changes from Original (DECEMBER 2020) to REV.A**

**Page**

---

Changed from product preview to production data.....All

---

PACKAGE OUTLINE DIMENSIONS

SOT-553-5

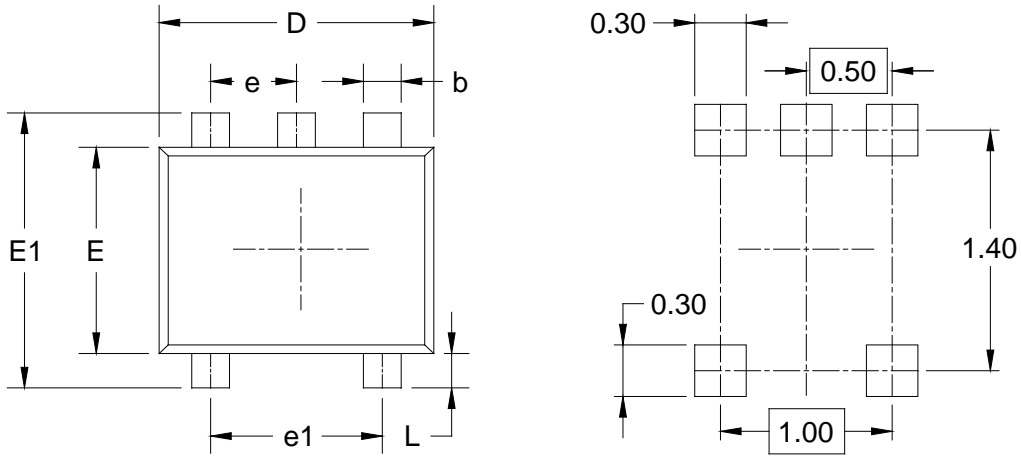

RECOMMENDED LAND PATTERN (Unit: mm)

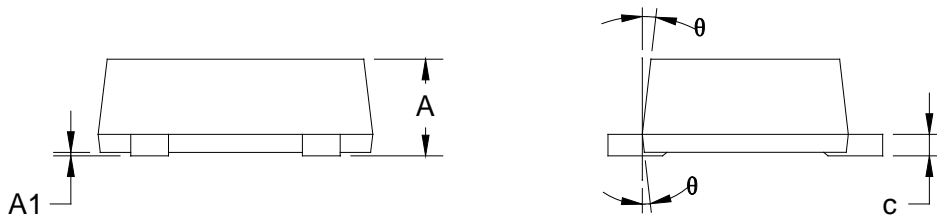

Symbol	Dimensions In Millimeters		Dimensions In Inches	
	MIN	MAX	MIN	MAX
A	0.525	0.600	0.021	0.024
A1	0.000	0.050	0.000	0.002
b	0.170	0.270	0.007	0.011
c	0.090	0.160	0.004	0.006
D	1.500	1.700	0.059	0.067
E	1.100	1.300	0.043	0.051
E1	1.500	1.700	0.059	0.067
e	0.500 TYP		0.020 TYP	
e1	1.000 TYP		0.040 TYP	
L	0.100	0.300	0.004	0.012
$\theta$	7° REF		7° REF	

# PACKAGE INFORMATION

## PACKAGE OUTLINE DIMENSIONS

### SOT-23-5

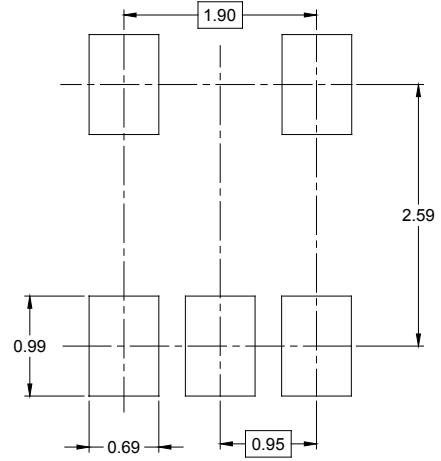
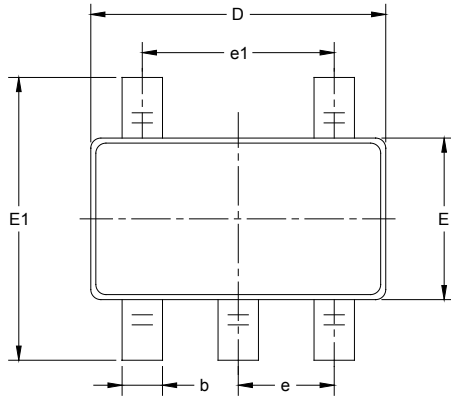

RECOMMENDED LAND PATTERN (Unit: mm)

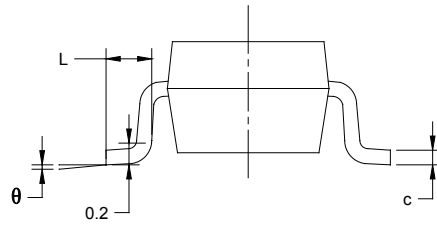
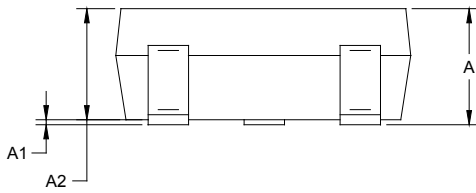

Symbol	Dimensions In Millimeters		Dimensions In Inches	
	MIN	MAX	MIN	MAX
A	1.050	1.250	0.041	0.049
A1	0.000	0.100	0.000	0.004
A2	1.050	1.150	0.041	0.045
b	0.300	0.500	0.012	0.020
c	0.100	0.200	0.004	0.008
D	2.820	3.020	0.111	0.119
E	1.500	1.700	0.059	0.067
E1	2.650	2.950	0.104	0.116
e	0.950 BSC		0.037 BSC	
e1	1.900 BSC		0.075 BSC	
L	0.300	0.600	0.012	0.024
$\theta$	0°	8°	0°	8°

PACKAGE OUTLINE DIMENSIONS

SOIC-8

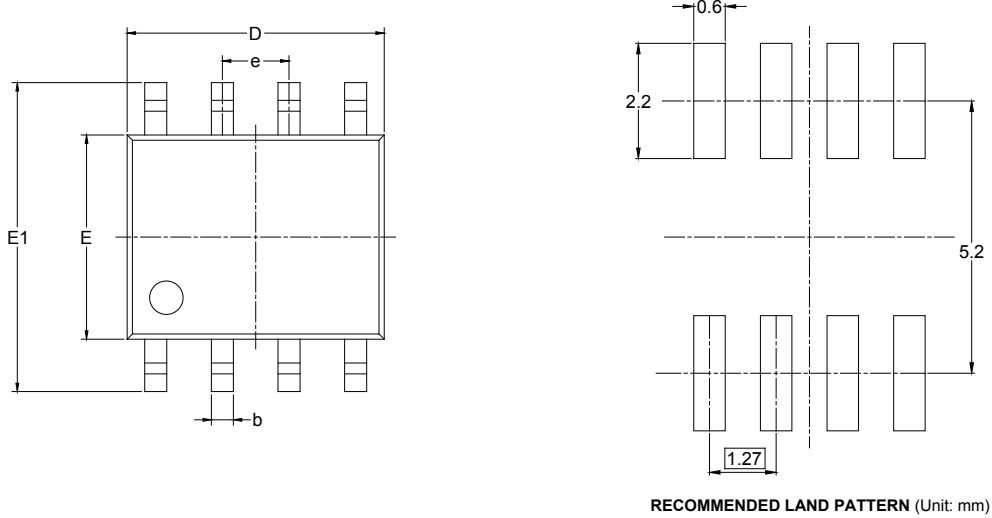

Symbol	Dimensions In Millimeters		Dimensions In Inches	
	MIN	MAX	MIN	MAX
A	1.350	1.750	0.053	0.069
A1	0.100	0.250	0.004	0.010
A2	1.350	1.550	0.053	0.061
b	0.330	0.510	0.013	0.020
c	0.170	0.250	0.006	0.010
D	4.700	5.100	0.185	0.200
E	3.800	4.000	0.150	0.157
E1	5.800	6.200	0.228	0.244
e	1.27 BSC		0.050 BSC	
L	0.400	1.270	0.016	0.050
$\theta$	0°	8°	0°	8°

PACKAGE OUTLINE DIMENSIONS

TDFN-3x3-8L

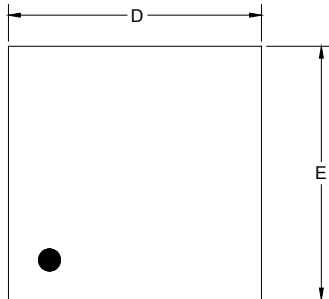

TOP VIEW

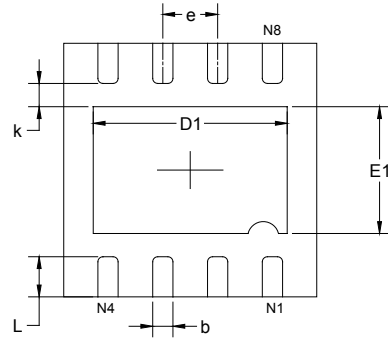

BOTTOM VIEW

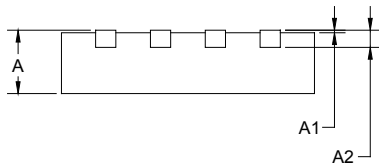

SIDE VIEW

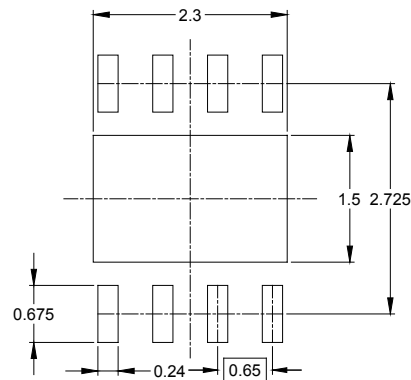

RECOMMENDED LAND PATTERN (Unit: mm)

Symbol	Dimensions In Millimeters		Dimensions In Inches	
	MIN	MAX	MIN	MAX
A	0.700	0.800	0.028	0.031
A1	0.000	0.050	0.000	0.002
A2	0.203 REF		0.008 REF	
D	2.900	3.100	0.114	0.122
D1	2.200	2.400	0.087	0.094
E	2.900	3.100	0.114	0.122
E1	1.400	1.600	0.055	0.063
k	0.200 MIN		0.008 MIN	
b	0.180	0.300	0.007	0.012
e	0.650 TYP		0.026 TYP	
L	0.375	0.575	0.015	0.023

# PACKAGE INFORMATION

## TAPE AND REEL INFORMATION

### REEL DIMENSIONS



### TAPE DIMENSIONS



NOTE: The picture is only for reference. Please make the object as the standard.

### KEY PARAMETER LIST OF TAPE AND REEL

Package Type	Reel Diameter	Reel Width W1 (mm)	A0 (mm)	B0 (mm)	K0 (mm)	P0 (mm)	P1 (mm)	P2 (mm)	W (mm)	Pin1 Quadrant
SOT-553-5	7"	9.5	1.78	1.78	0.69	4.0	4.0	2.0	8.0	Q3
SOT-23-5	7"	9.5	3.20	3.20	1.40	4.0	4.0	2.0	8.0	Q3
SOIC-8	13"	12.4	6.40	5.40	2.10	4.0	8.0	2.0	12.0	Q1
TDFN-3×3-8L	13"	12.4	3.35	3.35	1.13	4.0	8.0	2.0	12.0	Q1

D00001



# PACKAGE INFORMATION

## CARTON BOX DIMENSIONS



NOTE: The picture is only for reference. Please make the object as the standard.

## KEY PARAMETER LIST OF CARTON BOX

Reel Type	Length (mm)	Width (mm)	Height (mm)	Pizza/Carton
7" (Option)	368	227	224	8
7"	442	410	224	18
13"	386	280	370	5

DD0002