

General Description

- Trench Power MOSFET technology
- Low $R_{DS(ON)}$ at 2.5V V_{GS}
- Low Gate Charge
- RoHS and Halogen-Free Compliant

Applications

- Load switch, battery switch in portable devices

Product Summary

V_{DS}	30V
I_D (at $V_{GS}=10V$)	100A
$R_{DS(ON)}$ (at $V_{GS}=10V$)	< 1.6m Ω
$R_{DS(ON)}$ (at $V_{GS}=4.5V$)	< 1.9m Ω
$R_{DS(ON)}$ (at $V_{GS}=2.5V$)	< 2.9m Ω

Typical ESD Level

100% UIS Tested
100% Rg Tested

HBM Class 2

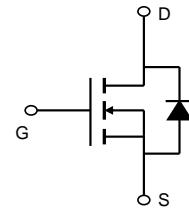
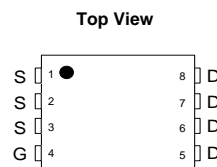
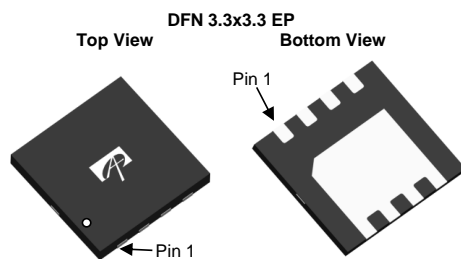

Orderable Part Number	Package Type	Form	Minimum Order Quantity
AONR34332C	DFN3.3x3.3 EP	Tape & Reel	5000

Absolute Maximum Ratings $T_A=25^\circ\text{C}$ unless otherwise noted

Parameter	Symbol	Maximum	Units
Drain-Source Voltage	V_{DS}	30	V
Gate-Source Voltage	V_{GS}	± 12	V
Continuous Drain Current ^C	I_D	$T_C=25^\circ\text{C}$	100
		$T_C=100^\circ\text{C}$	95
Pulsed Drain Current ^C	I_{DM}	400	A
Continuous Drain Current	I_{DSM}	$T_A=25^\circ\text{C}$	40
		$T_A=70^\circ\text{C}$	32
Avalanche Current ^C	I_{AS}	70	A
Avalanche energy $L=0.05\text{mH}$ ^C	E_{AS}	123	mJ
Power Dissipation ^B	P_D	$T_C=25^\circ\text{C}$	56
		$T_C=100^\circ\text{C}$	22
Power Dissipation ^A	P_{DSM}	$T_A=25^\circ\text{C}$	4.1
		$T_A=70^\circ\text{C}$	2.6
Junction and Storage Temperature Range	T_J, T_{STG}	-55 to 150	$^\circ\text{C}$

Thermal Characteristics

Parameter	Symbol	Typ	Max	Units
Maximum Junction-to-Ambient ^A	$R_{\theta JA}$	25	30	$^\circ\text{C/W}$
Maximum Junction-to-Ambient ^{A D}		Steady-State	50	60
Maximum Junction-to-Case	$R_{\theta JC}$	1.8	2.2	$^\circ\text{C/W}$

Electrical Characteristics (T_J=25°C unless otherwise noted)

Symbol	Parameter	Conditions	Min	Typ	Max	Units
STATIC PARAMETERS						
BV _{DSS}	Drain-Source Breakdown Voltage	I _D =250μA, V _{GS} =0V	30			V
I _{DSS}	Zero Gate Voltage Drain Current	V _{DS} =30V, V _{GS} =0V T _J =55°C			1 5	μA
I _{GSS}	Gate-Body leakage current	V _{DS} =0V, V _{GS} =±12V			±100	nA
V _{GS(th)}	Gate Threshold Voltage	V _{DS} =V _{GS} , I _D =250μA	0.5	0.85	1.2	V
R _{DS(ON)}	Static Drain-Source On-Resistance	V _{GS} =10V, I _D =20A T _J =125°C		1.3 1.9	1.6 2.4	mΩ
		V _{GS} =4.5V, I _D =20A		1.5	1.9	mΩ
		V _{GS} =2.5V, I _D =20A		2	2.9	mΩ
g _{FS}	Forward Transconductance	V _{DS} =5V, I _D =20A		150		S
V _{SD}	Diode Forward Voltage	I _S =1A, V _{GS} =0V		0.6	1	V
I _S	Maximum Body-Diode Continuous Current				50	A
DYNAMIC PARAMETERS						
C _{iss}	Input Capacitance	V _{GS} =0V, V _{DS} =15V, f=1MHz		5000		pF
C _{oss}	Output Capacitance			1450		pF
C _{rss}	Reverse Transfer Capacitance			200		pF
R _g	Gate resistance	f=1MHz	0.3	0.7	1.5	Ω
SWITCHING PARAMETERS						
Q _g (10V)	Total Gate Charge	V _{GS} =10V, V _{DS} =15V, I _D =20A		78	110	nC
Q _g (4.5V)	Total Gate Charge			36	50	nC
Q _{gs}	Gate Source Charge			10		nC
Q _{gd}	Gate Drain Charge			10		nC
t _{D(on)}	Turn-On DelayTime	V _{GS} =10V, V _{DS} =15V, R _L =0.75Ω, R _{GEN} =3Ω		9		ns
t _r	Turn-On Rise Time			8		ns
t _{D(off)}	Turn-Off DelayTime			85		ns
t _f	Turn-Off Fall Time			18		ns
t _{rr}	Body Diode Reverse Recovery Time	I _F =20A, di/dt=500A/μs		21		ns
Q _{rr}	Body Diode Reverse Recovery Charge	I _F =20A, di/dt=500A/μs		57		nC

A. The value of R_{θJA} is measured with the device mounted on 1in² FR-4 board with 2oz. Copper, in a still air environment with T_A=25° C. The Power dissipation P_{DSM} is based on R_{θJA} ≤ 10s and the maximum allowed junction temperature of 150° C. The value in any given application depends on the user's specific board design.

B. The power dissipation P_D is based on T_{J(MAX)}=150° C, using junction-to-case thermal resistance, and is more useful in setting the upper dissipation limit for cases where additional heatsinking is used.

C. Single pulse width limited by junction temperature T_{J(MAX)}=150° C.

D. The R_{θJA} is the sum of the thermal impedance from junction to case R_{θJC} and case to ambient.

E. The static characteristics in Figures 1 to 6 are obtained using <300μs pulses, duty cycle 0.5% max.

F. These curves are based on the junction-to-case thermal impedance which is measured with the device mounted to a large heatsink, assuming a maximum junction temperature of T_{J(MAX)}=150° C. The SOA curve provides a single pulse rating.

G. The maximum current rating is package limited.

H. These tests are performed with the device mounted on 1 in² FR-4 board with 2oz. Copper, in a still air environment with T_A=25° C.

APPLICATIONS OR USE AS CRITICAL COMPONENTS IN LIFE SUPPORT DEVICES OR SYSTEMS ARE NOT AUTHORIZED. AOS DOES NOT ASSUME ANY LIABILITY ARISING OUT OF SUCH APPLICATIONS OR USES OF ITS PRODUCTS. AOS RESERVES THE RIGHT TO IMPROVE PRODUCT DESIGN,FUNCTIONS AND RELIABILITY WITHOUT NOTICE.

TYPICAL ELECTRICAL AND THERMAL CHARACTERISTICS

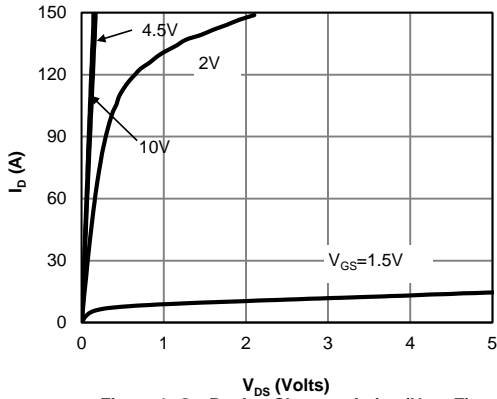

Figure 1: On-Region Characteristics (Note E)

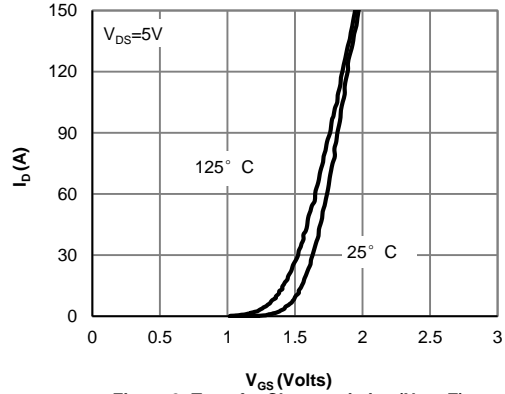

Figure 2: Transfer Characteristics (Note E)

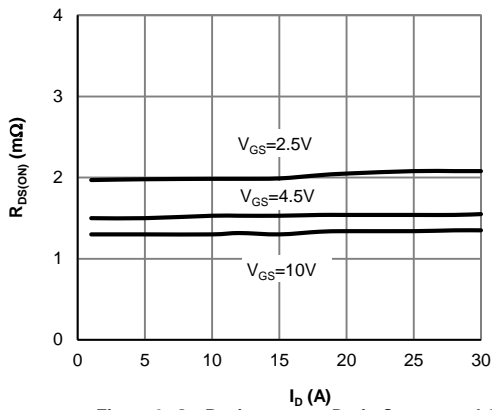

Figure 3: On-Resistance vs. Drain Current and Gate Voltage (Note E)

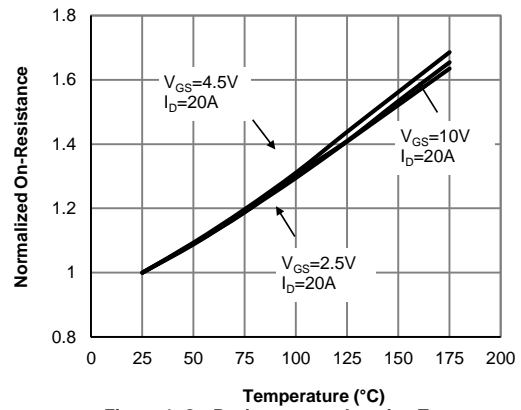

Figure 4: On-Resistance vs. Junction Temperature (Note E)

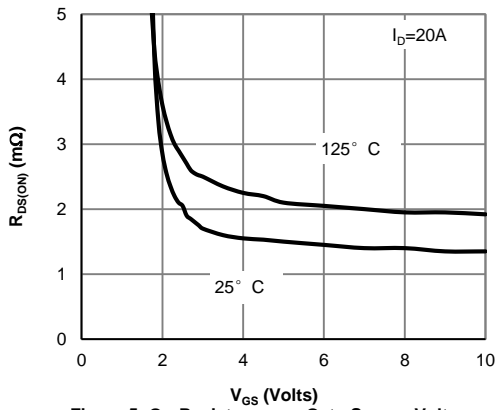

Figure 5: On-Resistance vs. Gate-Source Voltage (Note E)

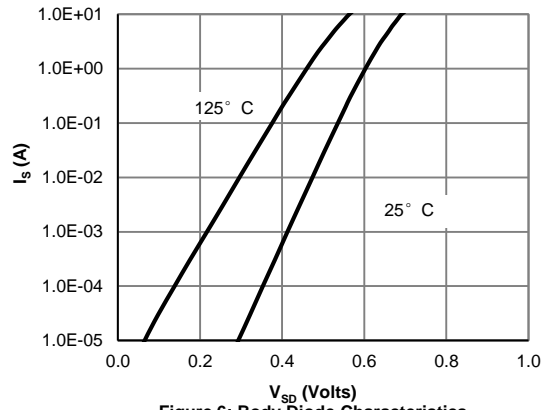

Figure 6: Body-Diode Characteristics (Note E)

TYPICAL ELECTRICAL AND THERMAL CHARACTERISTICS

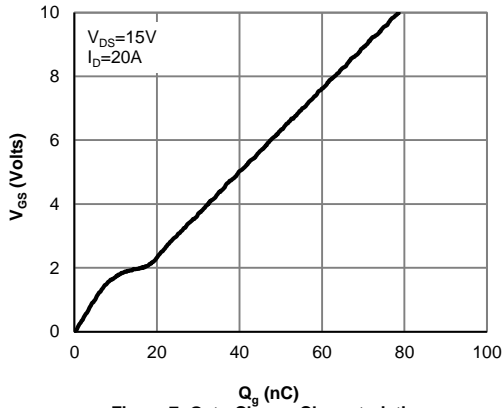

Figure 7: Gate-Charge Characteristics

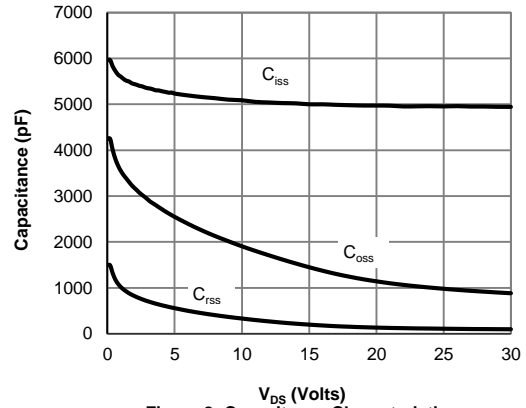

Figure 8: Capacitance Characteristics

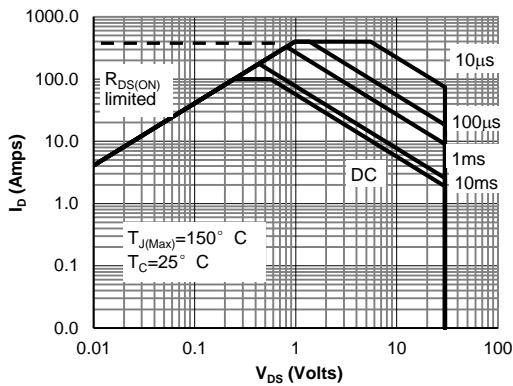

Figure 9: Maximum Forward Biased Safe Operating Area (Note F)

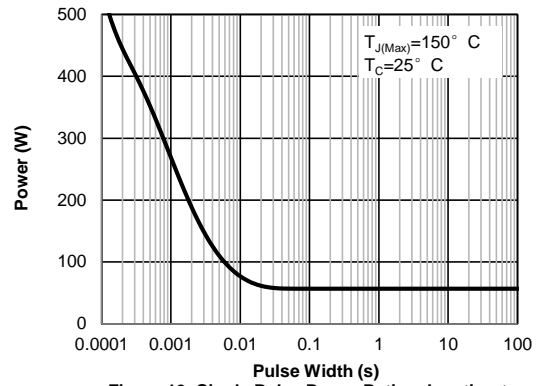

Figure 10: Single Pulse Power Rating Junction-to-Case (Note F)

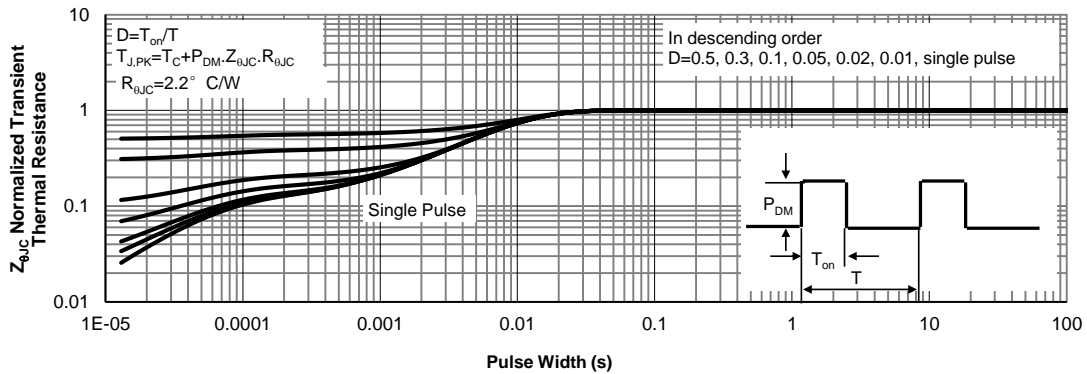

Figure 11: Normalized Maximum Transient Thermal Impedance (Note F)

TYPICAL ELECTRICAL AND THERMAL CHARACTERISTICS

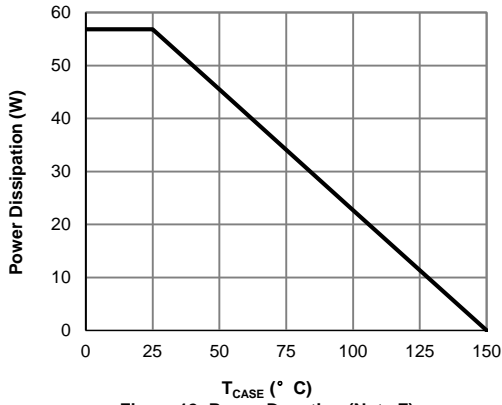

Figure 12: Power De-rating (Note F)

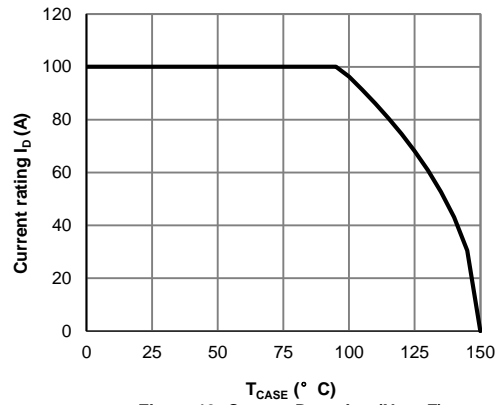

Figure 13: Current De-rating (Note F)

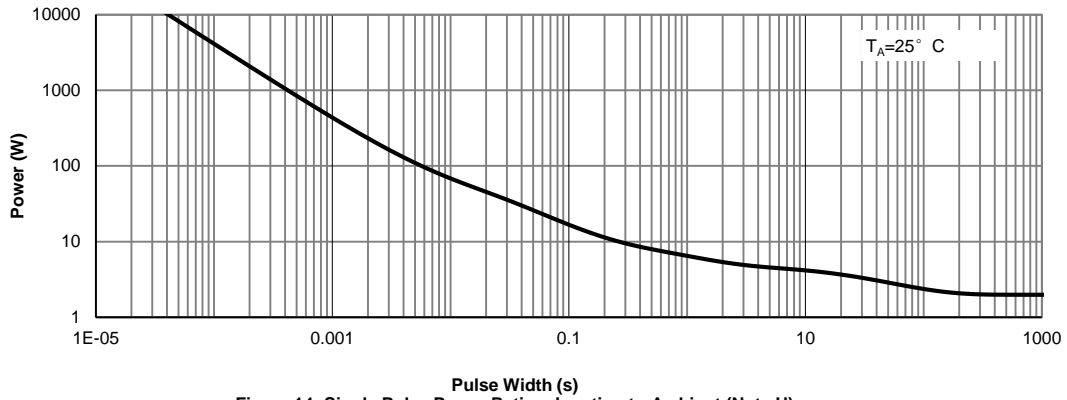

Figure 14: Single Pulse Power Rating Junction-to-Ambient (Note H)

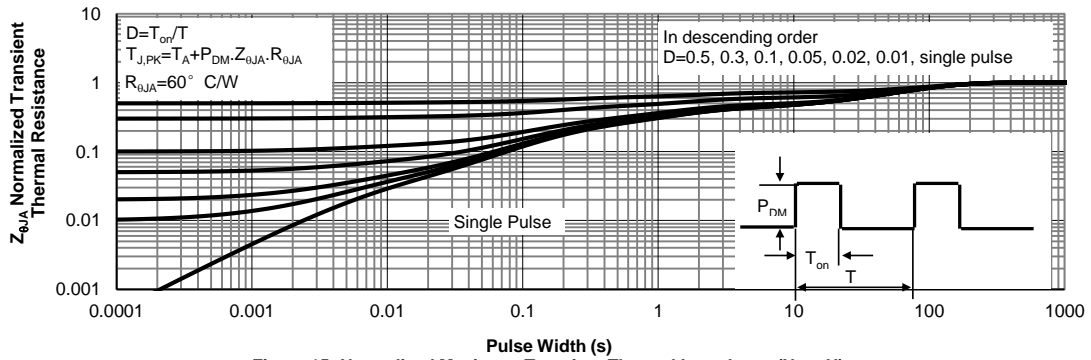

Figure 15: Normalized Maximum Transient Thermal Impedance (Note H)

Figure A: Gate Charge Test Circuit & Waveforms

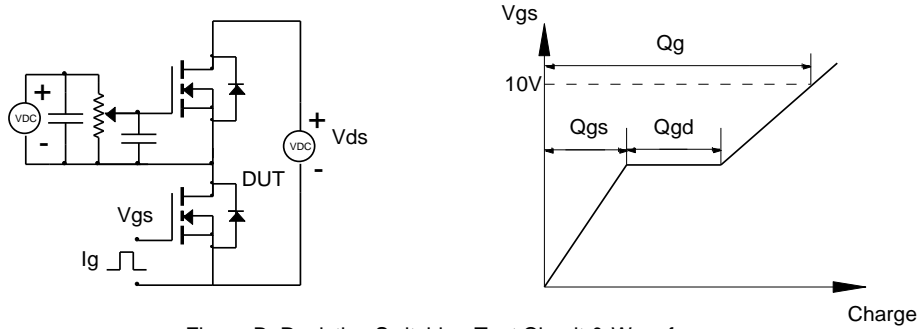

Figure B: Resistive Switching Test Circuit & Waveforms

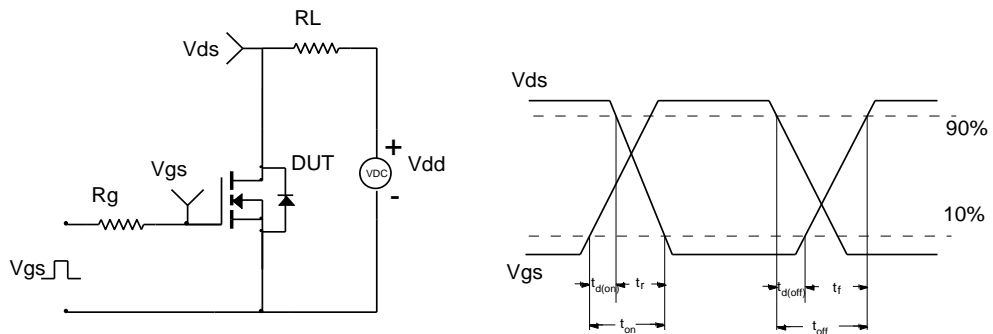

Figure C: Unclamped Inductive Switching (UIS) Test Circuit & Waveforms

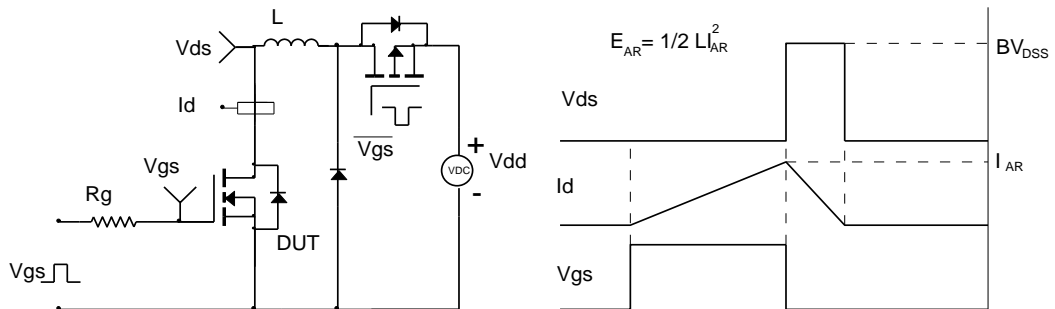

Figure D: Diode Recovery Test Circuit & Waveforms

