

Anderson Power Products' family of Euro Battery Connectors (EBC) exceeds all the requirements of DIN 43589-1 and EN 1175-1. The connector design incorporates an innovative, cost effective contact carrier for ease of assembly.

The connectors have a Degree of Protection of IP23 per IEC 60529. The acid resistance and temperature range of the PBT-PC housing exceeds the requirements of EN 1175-1. Contacts are pure copper with silver plate for maximum conductivity.

All materials meet RoHS requirements and are selected to ensure years of reliable service under adverse battery environments.

Features

- Sturdy Advanced Polymer Housings**

PBT-PC alloy housings provides superior resistance to acids and temperature extremes

- DIN 43589-1 Voltage Keying**

Dry-cell, wet-cell & universal keying plugs coded for 24 / 36 / 48 / 72 / 80 & 96 volts DC

- Mating Compatibility with Connectors of Other Manufacturers**

APP "E" series connectors offer dimensional compatibility for air tube and auxiliary contacts over and above the DIN 43589-1 compatibility of housings and main contacts



- Silver Plated Pure Copper Contacts**

For lowest voltage drop and superior performance

SPECIFICATIONS

Electrical		Mechanical	
Current Rating (Amperes) *		Life	
UL	340	a. No Load (mating cycles)	>5000
EN1175-1:1998	300	b. Under Load (Hot Plug 5 mating cycles @96V)	800A
CSA	260	Average Mating / Unmating Force (lbf)	12
Voltage Rating		(N)	53
UL / CSA	600	Degree of Protection	IP23
EN1175-1:1998	150	Acid Resistance	1.38g / cm ³
Wire Range		Contact Retention - minimum (lbf)	100
- Power Contacts - AWG (mm ²)	#1/0 to 4/0 (50 / 95)	(N)	445
- Auxiliary Contacts - AWG (mm ²)	#12 to #10 (4 / 6)	Air Tube Rating	2 bar
Dielectric Withstanding Voltage (AC)	2,200	Materials	
Average Contact Resistance (micro-ohms)	30	Housing	PBT/PC blend
Operating Temperature (°C)	-25° to 75°	Contacts	Copper alloy, silver plate
(°F)	-13° to 167°	Hardware	Steel, zinc chromate plate

* Current derating curves must be observed as current capacity will vary dependent on wire cross section and ambient temperature. Maximum current carrying capacity is measured at 40°C / 104°F using the maximum wire cross section permissible, crimped to contacts using APP recommended tooling.

ORDERING INFORMATION

Connector Part Number Selection

Series	Gender	Main Contact	Handle	Coding Key	Auxiliary Contacts & Air Tubes	Packaging
E32	4	50	- 1	0	2	9
4	Plug					9 Individual
00	None - Order Separately				0 None	8 Bulk
50	50 mm ² / #1/0 AWG				1 (2) Lower Auxiliary Contacts	
70	70 mm ² / #2/0 AWG				2 (2) Upper Auxiliary Contacts	
95	95 mm ² / #3/0 AWG				4 (2) Lower Auxiliary Contacts & (2) Upper Auxiliary Contacts	
0	No			0 Grey, Wet Cell	5 Air Tube	
1	Black			2 Green, Dry Cel	6 Air Tube & (2) Upper Auxiliary Contacts	
				3 Yellow, Universal		

Accessories

Part Number	Description
E320-20	Twin air tube
E16-89	Handle kit - low profile
E32-89	Handle kit - high profile
A320LP-MK	Latch plate for mating side
A320HL-MK	Handle with latch & hardware
994G4	Manual release bracket & handle
993G4	Manual release mounting plate for mating half

ORDERING INFORMATION

Tooling

Part Number	Description
1387G3	Hydraulic tool for power contacts
E160-36	Extraction tool

Note: For tooling die information, see tooling chart on website.

DIMENSIONS

Pin Contact

Part Number	- Wire -		- ØA -		- ØB -		- C -	
	mm ²	AWG	mm	in.	mm	in.	mm	in.
320-1050	50	#1/0	14.5	0.57	11.0	0.43	65.5	2.58
320-1070	70	#2/0	17.0	0.67	13.0	0.51	65.5	2.58
320-1095	95	#3/0	19.8	0.78	15.0	0.59	70.5	2.78

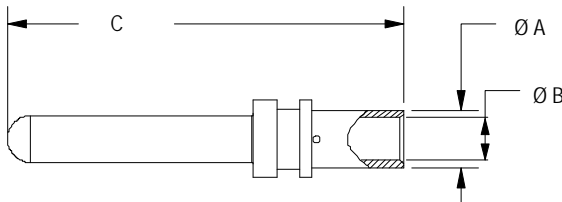

Upper Auxiliary Contact

E320-34 upper auxiliary contact for 4 mm² (#12 AWG)

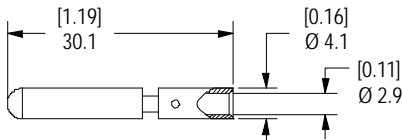

Lower Auxiliary Contact

160-12 lower auxiliary contact for 6 mm² (#10 AWG)

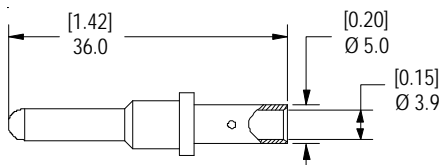

Handle / Lever Assembly / Latch

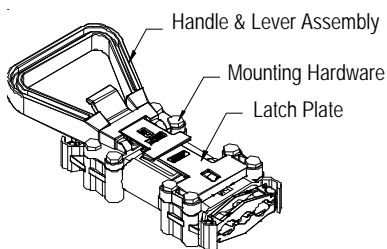

Housing Front View

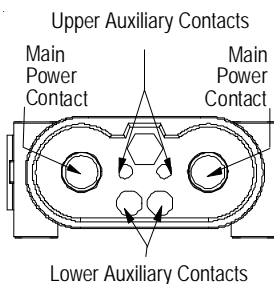

TEMPERATURE CHARTS

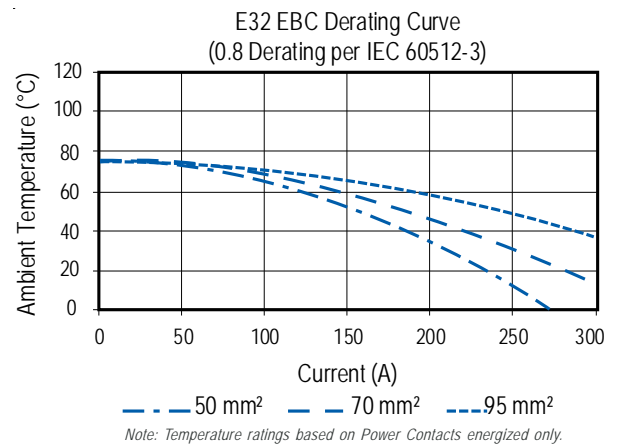
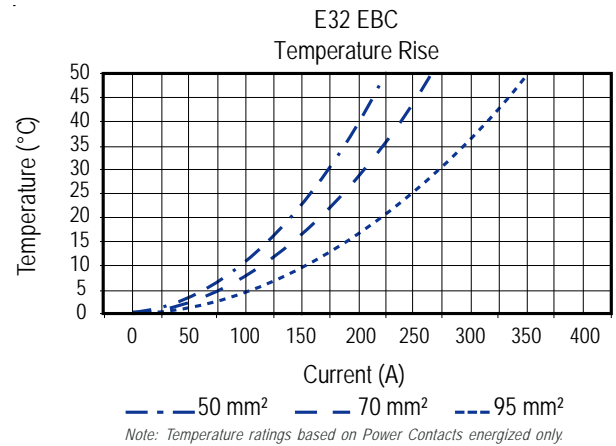

Housing Side View

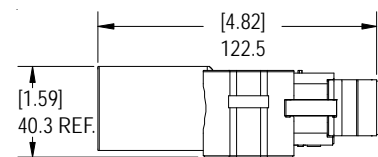

Housing Top View

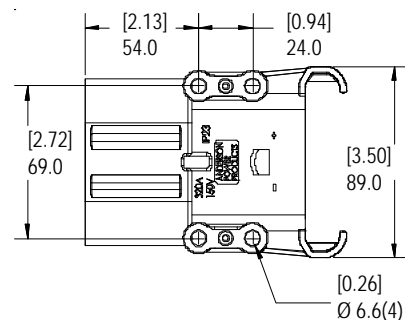

Mouser Electronics

Authorized Distributor

Click to View Pricing, Inventory, Delivery & Lifecycle Information:

Anderson Power Products:

[E320-34](#) [E32400-0009](#) [E32400-1009](#) [E32450-0008](#) [E32450-0009](#) [E32450-0019](#) [E32450-0029](#) [E32450-0249](#)
[E32470-0008](#) [E32450-1049](#) [E32450-0049](#) [E32450-1029](#) [E32450-0059](#) [E32450-1059](#) [E32495-1009](#) [E32495-1029](#)
[E32495-0009](#) [E32470-0049](#) [E32470-1049](#) [E32495-1049](#) [E32450-1009](#) [E32470-0009](#) [E32470-1009](#) [E32470-0019](#)
[E32470-1019](#) [E32495-0029](#) [E32450-1008](#) [E32450-1069](#) [E32470-0059](#) [E32470-1069](#) [E32450-1019](#) [E32470-0029](#)
[E32470-1029](#) [E32495-0049](#)