

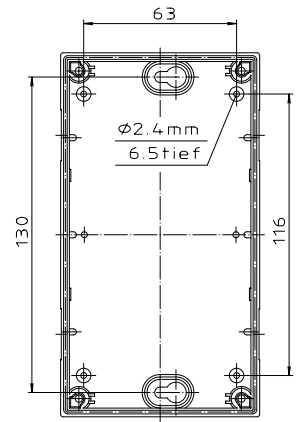

-SCHUTZZEICHEN NACH DIN 34 BEZEICHNEN-

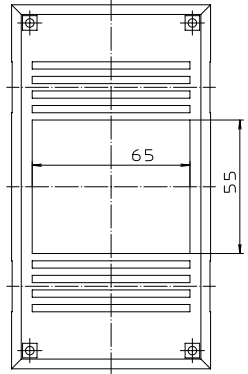

Unterteil von Innen

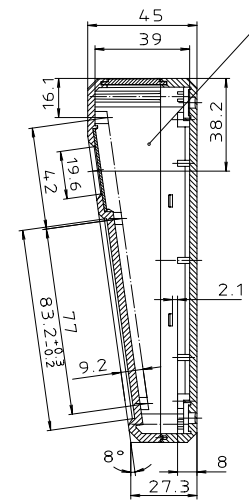

Ausführung "PD"

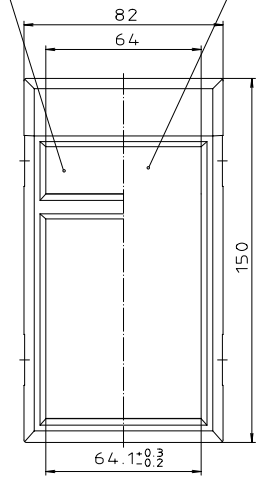

Ausführung "P"

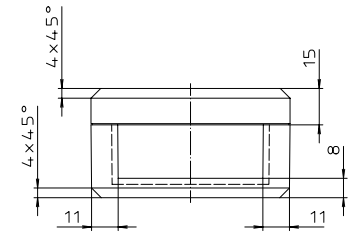
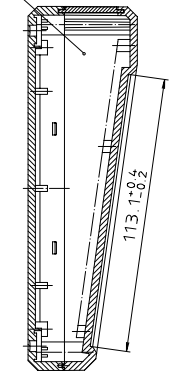

Ausführung "P"

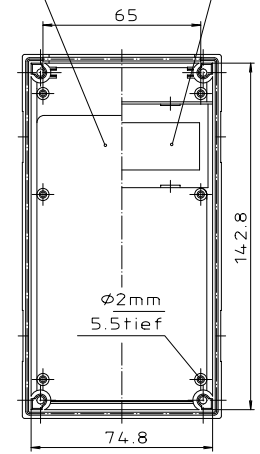

Ausführung "PD"

Oberteil von Innen

Maßstab: 1:1			
Zchn.Nr: 1G 5010.233.02			
Artikel: EG 1545 P/EG 1545 PD			
Katalogzeichnung			
3621 08.08.2002		DISK: 2 800 803	
Ar.Nr.: Datum:		Datum: 18.11.91 SM	
		A Plastic Pipe Company	