

**CONTINUOUS HINGE WITH CLAMPS, TYPE 4**

**INDUSTRY STANDARDS**

UL 50, 50E Listed; Type 4, 12, 13; File No. E27567  
 cUL Listed per CSA C22.2 No. 94; Type 4, 12, 13; File No. E27567  
 UL 508A Listed; Type 4, 12, 13; File No. E61997  
 cUL Listed per CSA C22.2 No. 94; Type 4, 12, 13; File No. E61997

NEMA/EEMAC Type 4, 12, 13  
 CSA, File No. 42184: Type 4 and 12  
 IEC 60529, IP66

**APPLICATION**

A continuous hinge combined with stainless steel clamps on three sides provide environmental protection and security in indoor or outdoor applications.

**SPECIFICATIONS**

- 16 or 14 gauge steel
- Seams continuously welded and ground smooth
- Stainless steel screw-down clamps on three sides of door
- Continuous hinge
- Stainless steel hinge pin
- Oil-resistant gasket
- Weldnuts provided for mounting optional panels and terminal block kits in size 6.00 x 4.00 in. (152 x 102 mm) and larger
- Bonding provision on door
- External welded-on mounting brackets for easy installation

**FINISH**

ANSI 61 gray polyester powder paint inside and out

**ACCESSORIES**

Panels for Junction Boxes  
 Fast-Operating Clamp-Cover Junction Box Clamp  
 Lock Kit for Clamp Cover Junction Boxes  
 Junction Box and Wall-Mount Enclosure Swing Out Panel Kit  
 Terminal Block Kit Assembly for Junction Boxes

**MODIFICATION AND CUSTOMIZATION**

Hoffman excels at modifying and customizing products to your specifications. Contact your local Hoffman sales office or distributor for complete information.

**BULLETIN: A51NF**

## Standard Product

Catalog Number	AxBxC in./mm	Gauge	UL Listed	Panel	Conductive Panel	Panel Size D x E in./mm	Mounting G x H in./mm	Overall L x W in./mm	F in./mm	J in./mm	K in./mm	M in./mm	N in./mm	T in./mm	V in./mm	Y in./mm
A404CHNF	4.00 x 4.00 x 3.00 102 x 102 x 76	16	508A	No Panel	No Panel	No Panel No Panel	4.75 x 2.00 121 x 51	5.50 x 4.94 140 x 125	— —	2.62 66	0.54 14	1.38 35	1.38 35	3.00 76	— —	— —
A604CHNF	6.00 x 4.00 x 3.00 152 x 102 x 76	16	508A	A6P4	A6P4G	4.88 x 2.88 124 x 73	6.75 x 2.00 171 x 51	7.50 x 4.94 191 x 125	2.53 64	2.62 66	0.54 14	1.38 35	2.38 60	3.00 76	0.31 8	0.56 14
A806CHNF	8.00 x 6.00 x 3.50 203 x 152 x 89	14	50, 50E	A8P6	A8P6G	6.75 x 4.88 171 x 124	8.75 x 4.00 222 x 102	9.50 x 6.94 241 x 176	3.03 77	3.12 79	0.56 14	2.38 60	3.38 86	5.00 127	0.25 6	0.62 16
A606CHNF	6.00 x 6.00 x 4.00 152 x 152 x 102	16	50, 50E	A6P6	A6P6G	4.88 x 4.88 124 x 124	6.75 x 4.00 171 x 102	7.50 x 6.94 191 x 176	3.53 90	3.62 92	0.54 14	2.38 60	2.38 60	5.00 127	0.31 8	0.56 14
A1264CHNF	12.00 x 6.00 x 4.00 305 x 152 x 102	14	50, 50E	A12P6	A12P6G	10.75 x 4.88 273 x 124	12.75 x 4.00 324 x 102	13.50 x 6.94 343 x 176	3.53 90	3.62 92	0.56 14	2.38 60	3.00 76	5.00 127	0.25 6	0.56 14
A808CHNF	8.00 x 8.00 x 4.00 203 x 203 x 102	14	50, 50E	A8P8	A8P8G	6.75 x 6.88 171 x 175	8.75 x 6.00 222 x 152	9.50 x 8.94 241 x 227	3.53 90	3.62 92	0.56 14	3.38 86	3.38 86	7.00 178	0.25 6	0.62 16
A1008CHNF	10.00 x 8.00 x 4.00 254 x 203 x 102	14	50, 50E	A10P8	A10P8G	8.75 x 6.88 222 x 175	10.75 x 6.00 273 x 152	11.50 x 8.94 292 x 227	3.53 90	3.62 92	0.56 14	3.38 86	1.50 38	7.00 178	0.25 6	0.62 16
A1210CHNF	12.00 x 10.00 x 5.00 305 x 254 x 127	14	50, 50E	A12P10	A12P10G	10.75 x 8.88 273 x 225	12.75 x 8.00 324 x 203	13.50 x 10.94 343 x 278	4.53 115	4.62 117	0.56 14	2.00 51	3.00 76	9.00 229	0.25 6	0.62 16
A1210CHNFS	12.00 x 10.00 x 5.00 305 x 254 x 127	14	50, 50E	A12P10	A12P10G	10.75 x 8.88 273 x 226	12.75 x 8.00 324 x 203	13.50 x 10.94 343 x 278	4.53 115	4.62 117	0.56 14	2.00 51	3.00 76	9.00 229	0.25 6	0.62 16
A8066CHNF	8.00 x 6.00 x 6.00 203 x 152 x 152	14	50, 50E	A8P6	A8P6G	6.75 x 4.88 171 x 124	8.75 x 4.00 222 x 102	9.50 x 6.94 241 x 176	5.53 140	5.62 143	0.56 14	2.38 60	3.38 86	5.00 127	0.25 6	0.62 16
A8086CHNF	8.00 x 8.00 x 6.00 203 x 203 x 152	14	50, 50E	A8P8	A8P8G	6.75 x 6.88 171 x 175	8.75 x 6.00 222 x 152	9.50 x 8.94 241 x 227	5.53 140	5.62 143	0.56 14	3.38 86	3.38 86	7.00 178	0.25 6	0.62 16
A10086CHNF	10.00 x 8.00 x 6.00 254 x 203 x 152	14	50, 50E	A10P8	A10P8G	8.75 x 6.88 222 x 175	10.75 x 6.00 273 x 152	11.50 x 8.94 292 x 227	5.53 140	5.62 143	0.56 14	3.38 86	1.50 38	7.00 178	0.25 6	0.62 16
A14086CHNF	14.00 x 8.00 x 6.00 356 x 305 x 152	14	50, 50E	A14P8	A14P8G	12.75 x 6.88 324 x 175	14.75 x 6.00 375 x 175	15.50 x 8.94 394 x 227	5.53 140	5.62 143	0.56 14	3.38 86	3.00 76	7.00 178	0.25 6	0.56 14
A10106CHNF	10.00 x 10.00 x 6.00 254 x 254 x 152	14	50, 50E	A10P10	A10P10G	8.75 x 8.88 222 x 226	10.75 x 8.00 273 x 203	11.50 x 10.94 292 x 278	5.53 140	5.62 143	0.56 14	1.50 38	1.50 38	9.00 229	0.25 6	0.62 16
A16106CHNF	16.00 x 10.00 x 6.00 406 x 254 x 152	14	50, 50E	A16P10	A16P10G	14.75 x 8.88 375 x 226	16.75 x 8.00 425 x 203	17.50 x 10.94 445 x 278	5.53 140	5.62 143	0.56 14	2.00 51	1.50 38	9.00 229	0.25 6	0.56 14
A1212CHNF	12.00 x 12.00 x 6.00 305 x 305 x 152	14	50, 50E	A12P12	A12P12G	10.75 x 10.88 273 x 276	12.75 x 10.00 324 x 254	13.50 x 12.94 343 x 329	5.53 140	5.62 143	0.56 14	2.50 64	2.50 64	11.00 279	0.25 6	0.62 16
A1412CHNF	14.00 x 12.00 x 6.00 356 x 305 x 152	14	50, 50E	A14P12	A14P12G	12.75 x 10.88 324 x 276	14.75 x 10.00 375 x 254	15.50 x 12.94 394 x 329	5.53 140	5.62 143	0.56 14	2.00 51	3.00 76	11.00 279	0.25 6	0.62 16

Catalog Number	AxBxC in./mm	Gauge	UL Listed	Panel	Conductive Panel	Panel Size D x E in./mm	Mounting G x H in./mm	Overall L x W in./mm	F in./mm	J in./mm	K in./mm	M in./mm	N in./mm	T in./mm	V in./mm	Y in./mm
A1412CHNFS	14.00 x 12.00 x 6.00	14	50, 50E	A14P12	A14P12G	12.75 x 10.88	14.75 x 10.00	15.50 x 12.94	5.53	5.62	0.56	2.00	3.00	11.00	0.25	0.62
	356 x 305 x 152					324 x 276	375 x 254	394 x 329	140	143	14	51	76	279	6	16
A1614CHNF	16.00 x 14.00 x 6.00	14	50, 50E	A16P14	A16P14G	14.75 x 12.88	16.75 x 12.00	17.50 x 14.94	5.53	5.62	0.56	3.50	1.50	13.00	0.25	0.62
	406 x 356 x 152					375 x 327	425 x 305	445 x 379	140	143	14	89	38	330	6	16
A1614CHNFS	16.00 x 14.00 x 6.00	14	50, 50E	A16P14	A16P14G	14.75 x 12.88	16.75 x 12.00	17.50 x 14.94	5.53	5.62	0.56	3.50	1.50	13.00	0.25	0.62
	406 x 356 x 152					375 x 327	425 x 305	445 x 379	140	143	14	89	38	330	6	16
A12108CHNF	12.00 x 10.00 x 8.00	14	50, 50E	A12P10	A12P10G	10.75 x 8.88	12.75 x 8.00	13.50 x 10.94	4.53	4.62	0.56	2.00	3.00	9.00	0.25	0.62
	305 x 254 x 203					273 x 226	324 x 203	343 x 278	115	117	14	51	76	229	6	16
A14128CHNF	14.00 x 12.00 x 8.00	14	50, 50E	A14P12	A14P12G	12.75 x 10.88	14.75 x 10.00	15.50 x 12.94	5.53	5.62	0.56	2.00	3.00	11.00	0.25	0.62
	356 x 305 x 203					324 x 276	375 x 254	394 x 329	140	143	14	51	76	279	6	16
A16148CHNF	16.00 x 14.00 x 8.00	14	50, 50E	A16P14	A16P14G	14.75 x 12.88	16.75 x 12.00	17.50 x 14.94	5.53	5.62	0.56	3.50	1.50	13.00	0.25	0.62
	406 x 356 x 203					375 x 327	425 x 305	445 x 379	140	143	14	89	38	330	6	16
A161410CHNF	16.00 x 14.00 x 10.00	14	50, 50E	A16P14	A16P14G	14.75 x 12.88	16.75 x 12.00	17.50 x 14.94	5.53	5.62	0.56	3.50	1.50	13.00	0.25	0.62
	406 x 356 x 254					375 x 327	425 x 305	445 x 379	140	143	14	89	38	330	6	16

Purchase panels separately. Optional stainless steel, conductive, composite and aluminum panels are available for most sizes.  
 Catalog numbers ending in "S" are hinged on short side.

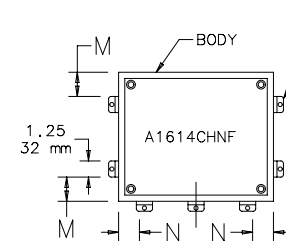
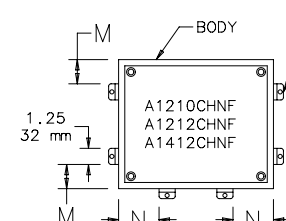
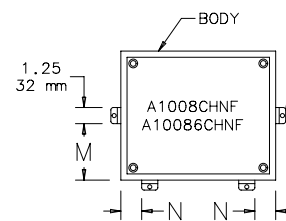
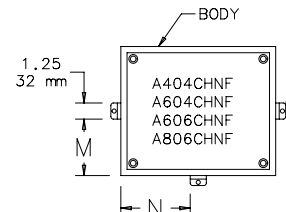
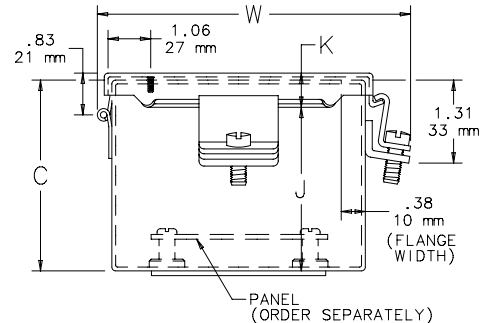
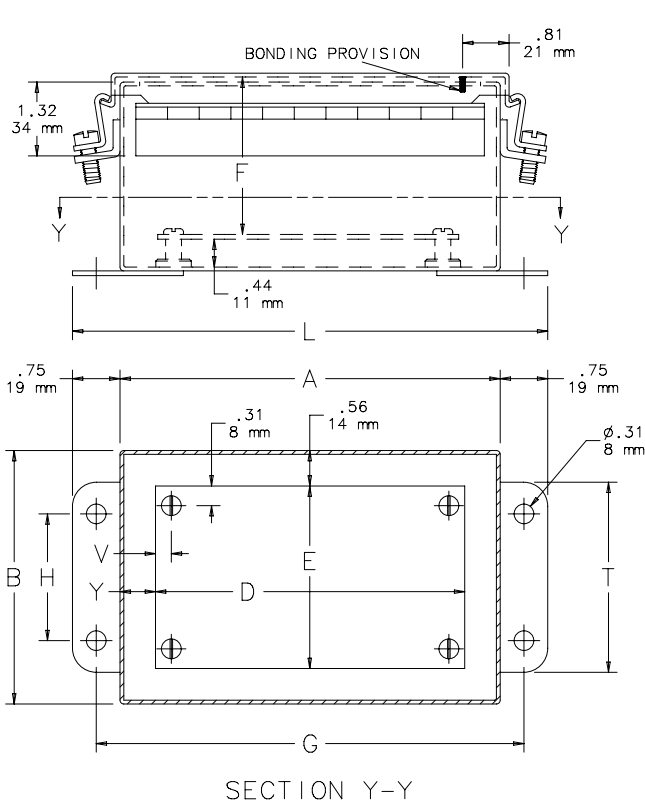

C2478-C