

FL SWITCH 2116 - Industrial Ethernet Switch



2702908

<https://www.phoenixcontact.com/us/products/2702908>

Please be informed that the data shown in this PDF document is generated from our online catalog. Please find the complete data in the user documentation. Our general terms of use for downloads are valid.

Managed Switch 2000, 16 RJ45 ports 10/100/1000 Mbps, PROFINET Conformance-Class A



Your advantages

- DHCP client, DHCP server (port-based)
- Unmanaged Mode
- MRP client
- RSTP
- VLANs
- Web-based management, SNMP
- Configuration memory
- Easy and fast startup and commissioning with the FL NETWORK MANAGER software
- Suitable for PROFINET and EtherNet/IP™ networks

Commercial data

Item number	2702908
Packing unit	1 pc
Minimum order quantity	1 pc
Sales key	DN17
Product key	DNN121
Catalog page	Page 305 (C-6-2019)
GTIN	4055626398716
Weight per piece (including packing)	576 g
Weight per piece (excluding packing)	377 g
Customs tariff number	85176200
Country of origin	DE

FL SWITCH 2116 - Industrial Ethernet Switch



2702908

<https://www.phoenixcontact.com/us/products/2702908>

Technical data

Dimensions

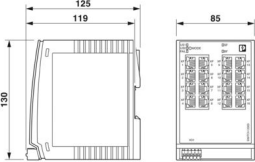
Dimensional drawing	
Width	85 mm
Height	130 mm
Depth	119 mm

Notes

General	Support by phone or on-site (fee is charged)
Note on application	Only for industrial use

Material specifications

Housing material	Polycarbonate fiber reinforced
------------------	--------------------------------

Mounting

Mounting type	DIN rail mounting
---------------	-------------------

Interfaces

Ethernet (RJ45)

Connection method	RJ45
Note on the connection method	Auto negotiation and autocrossing
Transmission speed	10/100/1000 Mbps
Transmission physics	Copper
Transmission length	100 m (per segment)
Signal LEDs	Data receive, link status
No. of channels	16 (RJ45 ports)

Product properties

Product type	Switch
Product family	Managed Switch 2000
Type	Book type
MTTF	379.84 Years (SN 29500 standard, temperature 25°C, operating cycle 21%)
	199.41 Years (SN 29500 standard, temperature 40°C, operating cycle 34.25%)
	40.42 Years (SN 29500 standard, temperature 55°C, operating cycle 100%)

FL SWITCH 2116 - Industrial Ethernet Switch



2702908

<https://www.phoenixcontact.com/us/products/2702908>

Signal delay	≥ 1.9 μs (Store-and-Forward mode, 10/100/1000 Mbps, depending on the frame size)
Data management status	
Article revision	03
Insulation characteristics	
Protection class	III (VDE 0106)
Degree of pollution	2
Switch functions	
Diagnostic functions	RMON History
	LLDP (Link Layer Discovery Protocol)
	SNMP-Traps
	N:1-Portmirroring
	ACD (Address Conflict Detection)
	SysLog
	CRC-Surveillance
Basic functions	Store-and-forward switch, complies with IEEE 802.3
PROFINET conformance class	Conformance-Class A
Filter functions	Quality of Service (8 priority classes)
	Class of Service
	DiffServ/DSCP
	Port-Priorisierung
	VLAN (up to 8 VLANs)
	IGMP Snooping/Querier (v1/v2)
	Auto-Query-Port
IP parameterization	DHCP-Client
	DHCP server (port based)
	BootP
MAC address table	8k
Management	Web-based management (HTTP/HTTPS)
	Role-based user management (LDAP)
	SNMPv1/v2/v3
	Command Line Interface (Telnet, SSH)
Redundancy	MRP (Media Redundancy Protocol)
	RSTP (Rapid Spanning Tree Protocol)
Status and diagnostic indicators	LEDs: US (power supply), 2 LEDs per Ethernet port (Link/Activity and Speed)
Additional functions	Jumbo frames (max. 9,600 bytes)
	Transmission of MMS and GOOSE (IEC 61850-8-1)
	Transmission of Modbus/TCP
Time synchronization	SNTP (Simple Network Time Protocol)

Security functions

FL SWITCH 2116 - Industrial Ethernet Switch



2702908

<https://www.phoenixcontact.com/us/products/2702908>

Basic functions	Store-and-forward switch, complies with IEEE 802.3
-----------------	--

Electrical properties

Local diagnostics	US Supply voltage Green LED
	LINK Link status Green LED
	SPD Data transmission speed Green/orange LED
Maximum power dissipation for nominal condition	12.6 W (At $U_S = 18$ V DC and 60°C ambient temperature)
Test voltage	500 V DC
Test section	for one minute 500 V DC
Transmission medium	Copper

Supply

Supply voltage (DC)	24 V DC (single)
Supply voltage range	18 V DC ... 32 V DC
Power supply connection	via COMBICON, max. conductor cross section 1.5 mm ²
Residual ripple	3.6 V _{PP} (within the permitted voltage range)
Max. current consumption	0.7 A (At $U_S = 18$ V DC and 60°C ambient temperature)
Typical current consumption	315 mA (at $U_S = 24$ V DC and 25 °C ambient temperature)
Current consumption	455 mA

Connection data

Connection method	Push-in spring connection
Note on the connection method	Use only copper connecting cables providing the permitted temperature range (-40 °C ... 75 °C).
Conductor cross section, rigid	0.25 mm ² ... 1.5 mm ²
Conductor cross section, flexible	0.25 mm ² ... 1.5 mm ²
Conductor cross section AWG	24 ... 16
Stripping length	9 mm

Environmental and real-life conditions

Ambient conditions

Degree of protection	IP20
Ambient temperature (operation)	0 °C ... 60 °C
Ambient temperature (storage/transport)	-40 °C ... 85 °C
Permissible humidity (operation)	10 % ... 95 % (non-condensing)
Permissible humidity (storage/transport)	10 % ... 95 % (non-condensing)
Shock (operation)	30g (EN 60068-2-27)
Vibration (operation)	2g, according to IEC 60068-2-6
Air pressure (operation)	86 kPa ... 108 kPa (1500 m above sea level)
Air pressure (storage/transport)	86 kPa ... 108 kPa (1500 m above sea level)

Standards and regulations

Free from substances that could impair the application of coating	Yes
---	-----

Approvals

FL SWITCH 2116 - Industrial Ethernet Switch



2702908

<https://www.phoenixcontact.com/us/products/2702908>

UL, USA/Canada

Identification	cULus
Note	UL 61010-1, Ed. 3 / UL 61010-2-201, Ed. 1, CSA C22.2 NO. 61010-2-201:14, Ed. 1 / CSA C22.2 NO.61010-1-12, Ed. 3

EMC data

Conformance with EMC directives	EN 61000-6-2 EN 61000-4-2 (ESD) Criterion B
	EN 61000-6-2 EN 61000-4-3 (electromagnetic fields) Criterion A
	EN 61000-6-2 EN 61000-4-4 (EFT burst) Criterion A
	EN 61000-6-2 EN 61000-4-5 (surge) Criterion B
	EN 61000-6-2 EN 61000-4-6 (line noise immunity) Criterion A
	EN 61000-6-2 EN 61000-6-3 (noise emission) Class B
	EN 61000-6-2 EN 61000-6-3 (conducted emissions) Class B
Noise immunity	EN 61000-6-2
Electromagnetic compatibility	Conformance with EMC Directive 2014/30/EU
Noise emission	EN 61000-6-4

System properties

Functionality

Basic functions	Store-and-forward switch, complies with IEEE 802.3
-----------------	--

Signaling

Status display	LEDs: US (power supply), 2 LEDs per Ethernet port (Link/Activity and Speed)
----------------	---

FL SWITCH 2116 - Industrial Ethernet Switch



2702908

<https://www.phoenixcontact.com/us/products/2702908>

Drawings

Dimensional drawing

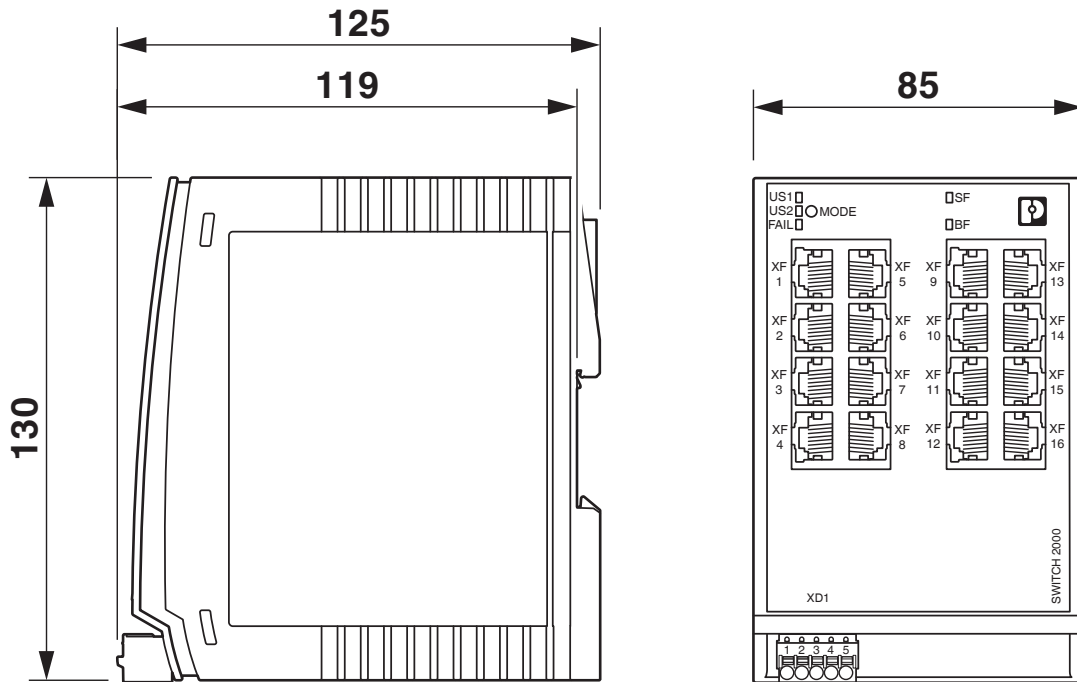

FL SWITCH 2116 - Industrial Ethernet Switch



2702908

<https://www.phoenixcontact.com/us/products/2702908>

Approvals

To download certificates, visit the product detail page: <https://www.phoenixcontact.com/us/products/2702908>



EAC

Approval ID: RU*-DE.*.B.00741/19

BSH

Approval ID: 1045



CC-Link IE Field

Approval ID: Ref. No. 184

UAE-RoHS

Approval ID: 23-02-63229



cULus Listed

Approval ID: E238705

FL SWITCH 2116 - Industrial Ethernet Switch



2702908

<https://www.phoenixcontact.com/us/products/2702908>

Classifications

ECLASS

ECLASS-11.0	19170401
ECLASS-12.0	19170401
ECLASS-13.0	19170401

ETIM

ETIM 9.0	EC000734
----------	----------

UNSPSC

UNSPSC 21.0	43222600
-------------	----------

FL SWITCH 2116 - Industrial Ethernet Switch



2702908

<https://www.phoenixcontact.com/us/products/2702908>

Environmental product compliance

EU RoHS

Fulfills EU RoHS substance requirements	Yes
Exemption	7(a), 7(c)-I

China RoHS

Environment friendly use period (EFUP)	EFUP-50
	An article-related China RoHS declaration table can be found in the download area for the respective article under "Manufacturer declaration". For all articles with EFUP-E, no China RoHS declaration table issued and required.

EU REACH SVHC

REACH candidate substance (CAS No.)	Lead(CAS: 7439-92-1)
SCIP	92a105f8-0da1-4802-8962-cc4c6857b6ec

EF3.0 Climate Change

CO2e kg	17.22 kg CO2e
---------	---------------

FL SWITCH 2116 - Industrial Ethernet Switch



2702908

<https://www.phoenixcontact.com/us/products/2702908>

Accessories

SD FLASH 2GB - Program / configuration memory

2988162

<https://www.phoenixcontact.com/us/products/2988162>



Program and configuration memory, for extending the internal flash memory, pluggable, 2 GB.

FL NETWORK MANAGER BASIC - Network management software

2702889

<https://www.phoenixcontact.com/us/products/2702889>



SNMP-based software for easy commissioning and monitoring of network components such as switches, routers, and WLAN access points

FL SWITCH 2116 - Industrial Ethernet Switch



2702908

<https://www.phoenixcontact.com/us/products/2702908>

FL DIN RA - DIN rail adapter

2891053

<https://www.phoenixcontact.com/us/products/2891053>

The FL DIN RA is installed in a standard, 19-inch rack (EIA-310-D, IEC 60297-3-100) to allow DIN rail mounted equipment to be rack mounted.



FL RJ45 PROTECT CAP - Dust protection

2832991

<https://www.phoenixcontact.com/us/products/2832991>

Dust protection caps for RJ45 socket

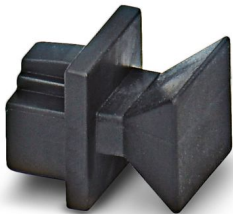

FL SWITCH 2116 - Industrial Ethernet Switch

2702908

<https://www.phoenixcontact.com/us/products/2702908>

E/NS 35 N - End bracket

0800886

<https://www.phoenixcontact.com/us/products/0800886>

End clamp, width: 9.5 mm, color: gray

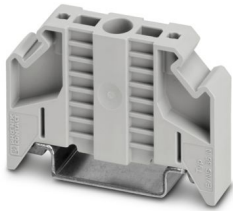

FK-MCP 1,5/ 5-ST-3,81GY35BD1-5 - PCB connector

1015782

<https://www.phoenixcontact.com/us/products/1015782>

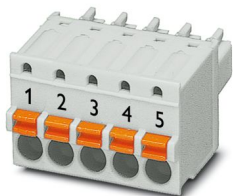

PCB connector, nominal cross section: 1.5 mm², color: light gray, nominal current: 8 A, rated voltage (III/2): 160 V, contact surface: Tin, contact connection type: Socket, number of potentials: 5, number of rows: 1, number of positions: 5, number of connections: 5, product range: FK-MCP 1,5/...-ST, pitch: 3.81 mm, connection method: Push-in spring connection, conductor/PCB connection direction: 0 °, plug-in system: COMBICON MC 1,5, locking: without, mounting: without, type of packaging: packed in cardboard

FL SWITCH 2116 - Industrial Ethernet Switch



2702908

<https://www.phoenixcontact.com/us/products/2702908>

MCVW 1,5/ 5-ST-3,81GY7035BD2US - PCB connector

1034103

<https://www.phoenixcontact.com/us/products/1034103>



PCB connector, nominal cross section: 1.5 mm², color: light gray, nominal current: 8 A, rated voltage (III/2): 160 V, contact surface: Tin, contact connection type: Socket, number of potentials: 5, number of rows: 1, number of positions: 5, number of connections: 5, product range: MCVW 1,5/...-ST, pitch: 3.81 mm, connection method: Screw connection with tension sleeve, screw head form: L Slotted, conductor/PCB connection direction: -90 °, plug-in system: COMBICON MC 1,5, locking: without, mounting: without, type of packaging: packed in cardboard

FL CAT5 PATCH 0,5 - Patch cable

2832263

<https://www.phoenixcontact.com/us/products/2832263>



Patch cable, CAT5, assembled, 0.5 m

FL SWITCH 2116 - Industrial Ethernet Switch



2702908

<https://www.phoenixcontact.com/us/products/2702908>

FL CAT5 PATCH 1,0 - Patch cable

2832276

<https://www.phoenixcontact.com/us/products/2832276>

Patch cable, CAT5, assembled, 1 m



FL CAT5 PATCH 2,0 - Patch cable

2832289

<https://www.phoenixcontact.com/us/products/2832289>

Patch cable, CAT5, assembled, 2 m



FL SWITCH 2116 - Industrial Ethernet Switch



2702908

<https://www.phoenixcontact.com/us/products/2702908>

NBC-R4AC-R4AC-IE8A/.../... - Patch cable

1411854

<https://www.phoenixcontact.com/us/products/1411854>

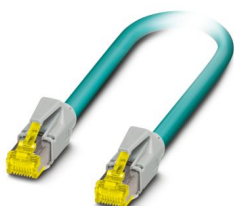

Patch cable, degree of protection: IP20, number of positions: 8, 10 Gbps, CAT6_A, cable outlet: straight, Ethernet

NBC-R4AC/10G-R4AC/10G-94F/2,0 - Patch cable

1408360

<https://www.phoenixcontact.com/us/products/1408360>

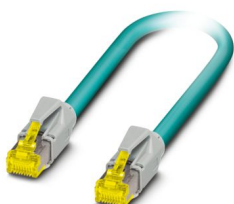

Patch cable, CAT6_A, 4-pair, shielded, connection not crossed (line), assembled at both ends with RJ45/IP20 connectors, outer sheath material: PUR, length: 2.0 m

FL SWITCH 2116 - Industrial Ethernet Switch



2702908

<https://www.phoenixcontact.com/us/products/2702908>

NBC-R4AC/10G-R4AC/10G-94F/3,0 - Patch cable

1408365

<https://www.phoenixcontact.com/us/products/1408365>

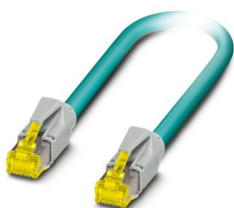

Patch cable, CAT6_A, 4-pair, shielded, connection not crossed (line), assembled at both ends with RJ45/IP20 connectors, outer sheath material: PUR, length: 3.0 m

NBC-R4AC/1,0-93B/R4AC - Patch cable

1408968

<https://www.phoenixcontact.com/us/products/1408968>



Patch cable, degree of protection: IP20, cable length: 1 m, number of positions: 4, 100 Mbps, CAT5, material: PA 6.6, PROFINET

FL SWITCH 2116 - Industrial Ethernet Switch



2702908

<https://www.phoenixcontact.com/us/products/2702908>

NBC-R4AC/2,0-93B/R4AC - Patch cable

1408969

<https://www.phoenixcontact.com/us/products/1408969>



Patch cable, degree of protection: IP20, cable length: 2 m, number of positions: 4, 100 Mbps, CAT5, material: PA 6.6, PROFINET

NBC-R4AC/5,0-93B/R4AC - Patch cable

1408970

<https://www.phoenixcontact.com/us/products/1408970>



Patch cable, degree of protection: IP20, cable length: 5 m, number of positions: 4, 100 Mbps, CAT5, material: PA 6.6, PROFINET

FL SWITCH 2116 - Industrial Ethernet Switch



2702908

<https://www.phoenixcontact.com/us/products/2702908>

VS-08-RJ45-5-Q/IP20 - RJ45 connector

1656725

<https://www.phoenixcontact.com/us/products/1656725>



RJ45 connector, design: RJ45, degree of protection: IP20, number of positions: 8, 1 Gbps, CAT5, material: Plastic, connection method: Insulation displacement connection, connection cross section: AWG 26- 23, cable outlet: straight, color: traffic grey A RAL 7042, Ethernet

Phoenix Contact 2024 © - all rights reserved

<https://www.phoenixcontact.com>

Phoenix Contact USA
586 Fulling Mill Road
Middletown, PA 17057, United States
(+717) 944-1300
info@phoenixcon.com