

SF2248D

314.45 MHz
SAW Filter

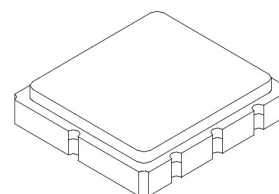

SM3838-8

- **Low-loss RF Filter for 315 MHz Applications**
- **No Matching Required for Operation in 50 Ω Environment**
- **Complies with Directive 2002/95/EC (RoHS)**
- **Moisture Sensitivity Level: 1**
- **AEC-Q200 Qualified**

Absolute Maximum Ratings

Rating	Value	Units
Input Power Level	10	dBm
DC Voltage on any Non-ground Terminal	3	V
Operating Temperature Range	-40 to +125	$^{\circ}$ C
Storage Temperature Range - SAW	-40 to +125	$^{\circ}$ C
Storage Temperature Range in Tape and Reel	-40 to +85	$^{\circ}$ C
Solder Reflow Temperature, 5 Cycles Maximum	260 $^{\circ}$ C for 10 Seconds	

Electrical Characteristics

Characteristic	Sym	Notes	Min	Typ	Max	Units
Center Frequency	f_C			314.45		MHz
3 dB Bandwidth			1.2	5.7		MHz
Insertion Loss, 313.85 to 315.05 MHz	IL_{MAX}			1.7	2.50	dB
Amplitude Ripple, 313.85 to 315.05 MHz				0.4	1.2	dB _{P-P}
VSWR				1.4:1	1.6:1	
Attenuation Referenced to IL_{MAX} :						dB
270.0 to 293.9 MHz			49	58		
293.9 to 304.6 MHz			37	47		
335.4 to 340.0 MHz			24	34		
340.0 to 500.0 MHz			36	45		
500.0 to 885.0 MHz			50	60		
885.0 to 1200.0 MHz			44	54		
1200.0 to 1578.0 MHz			36	46		
Source Impedance	Z_S			50		Ω
Load Impedance	Z_L			50		Ω

Case Style	SM3838-8 3.8 x 3.8 mm Nominal Footprint		
Lid Symbolization, Y=year, WW=week, S=shift, Dot=pin 1 indicator	B59, <u>YWWS</u>		
Standard Reel Quantity	Reel Size 7 Inch	500 Pieces/Reel	
	Reel Size 13 Inch	3000 Pieces/Reel	

Electrical Connections

Connection	Terminals
Input	1
Output	5
Case Ground	All others



CAUTION: Electrostatic Sensitive Device. Observe precautions for handling.

NOTES:

1. The design, manufacturing process, and specifications of this device are subject to change.
2. US or International patents may apply.
3. RoHS compliant from the first date of manufacture.

Amplitude Response Plots

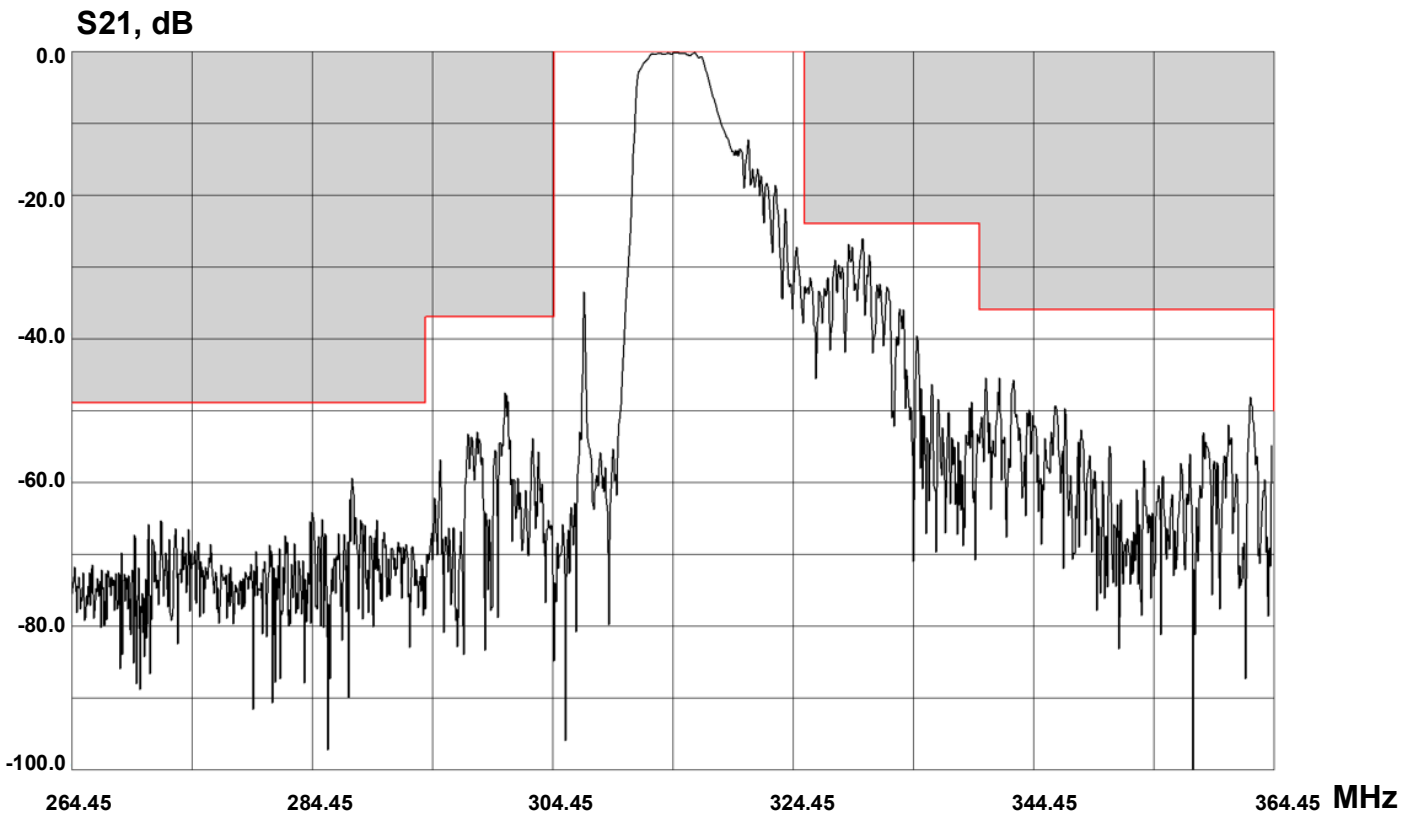
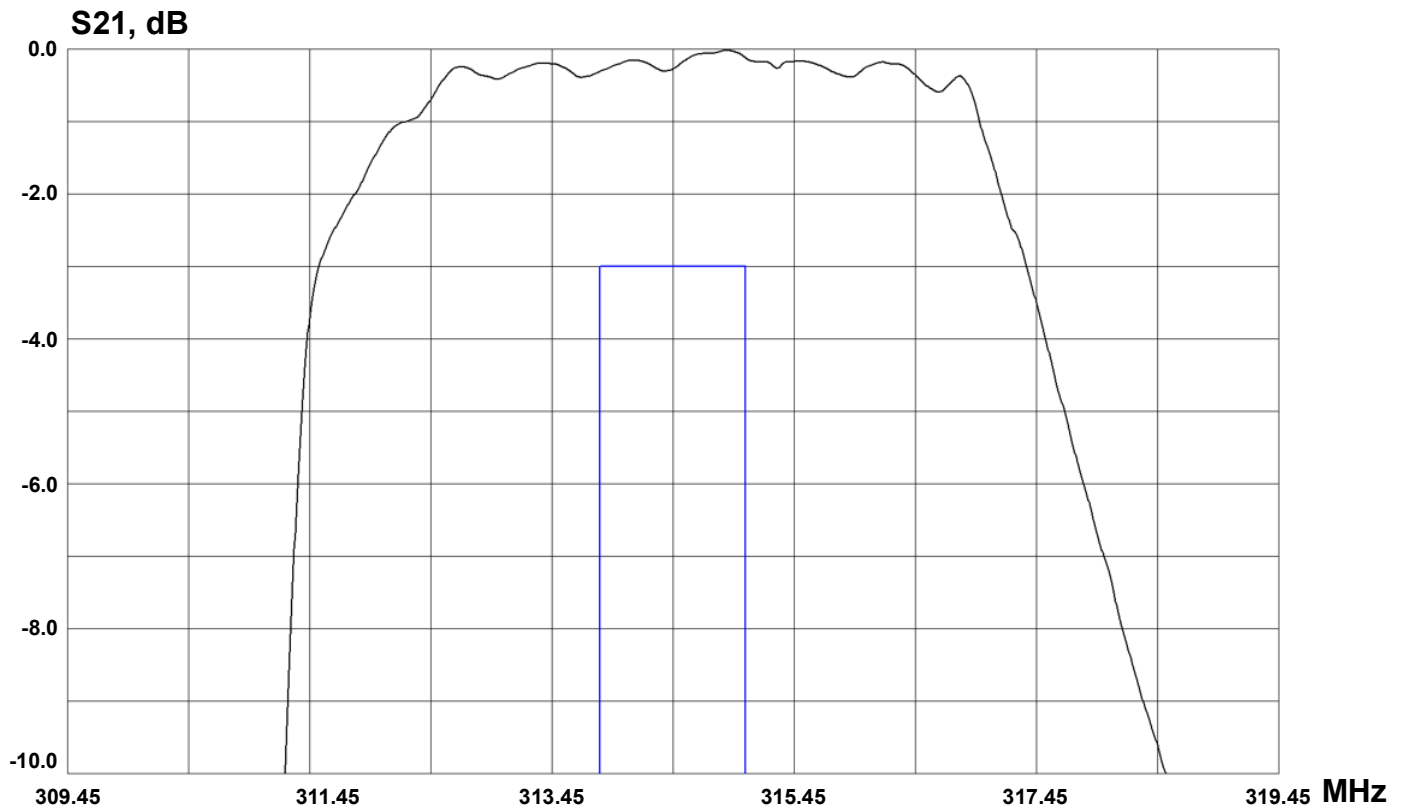

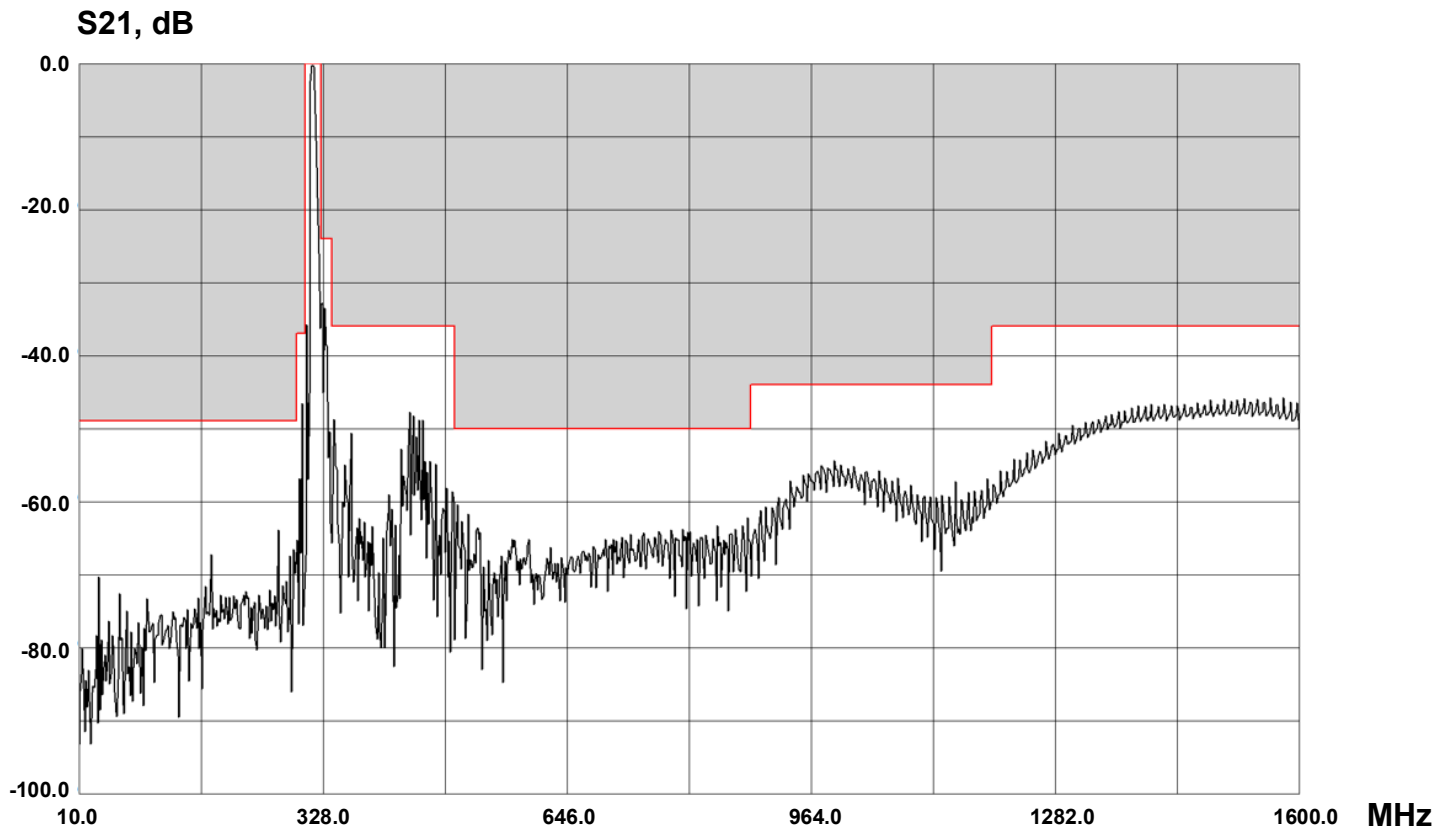

SM3838-8 Case

8-Terminal Ceramic Surface-Mount Case 3.8 X 3.8 mm Nominal Footprint

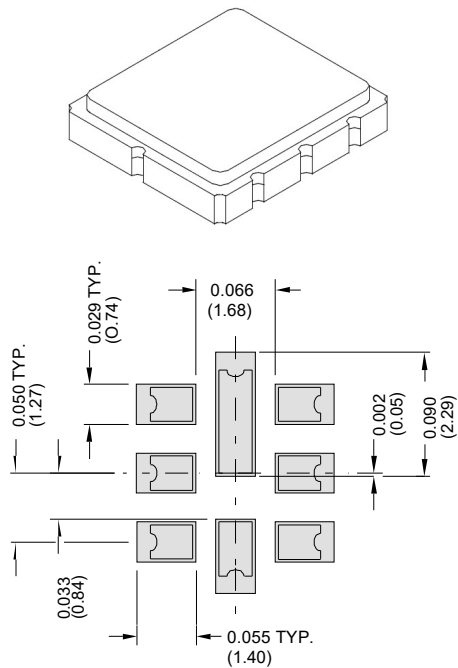

PCB Footprint Top View

Case Dimensions

Dimension	mm			Inches		
	Min	Nom	Max	Min	Nom	Max
A	3.60	3.80	4.00	0.140	0.150	0.160
B	3.60	3.80	4.00	0.140	0.15	0.160
C	1.00	1.20	1.40	0.040	0.05	0.055
D	0.95	1.10	1.25	0.033	0.043	0.050
E	0.90	1.0	1.10	0.035	0.040	0.043
F	0.50	0.60	0.70	0.020	0.024	0.028
G	2.39	2.54	2.69	0.090	0.100	0.110
H	1.40	1.75	2.05	0.055	0.069	0.080

Case Material

Materials	
Solder Pad Plating	0.3 to 1.0 μ m Gold over 1.27 to 8.89 μ m Nickel
Lid Plating	2.0 to 3.0 μ m Nickel
Body	Al ₂ O ₃ Ceramic

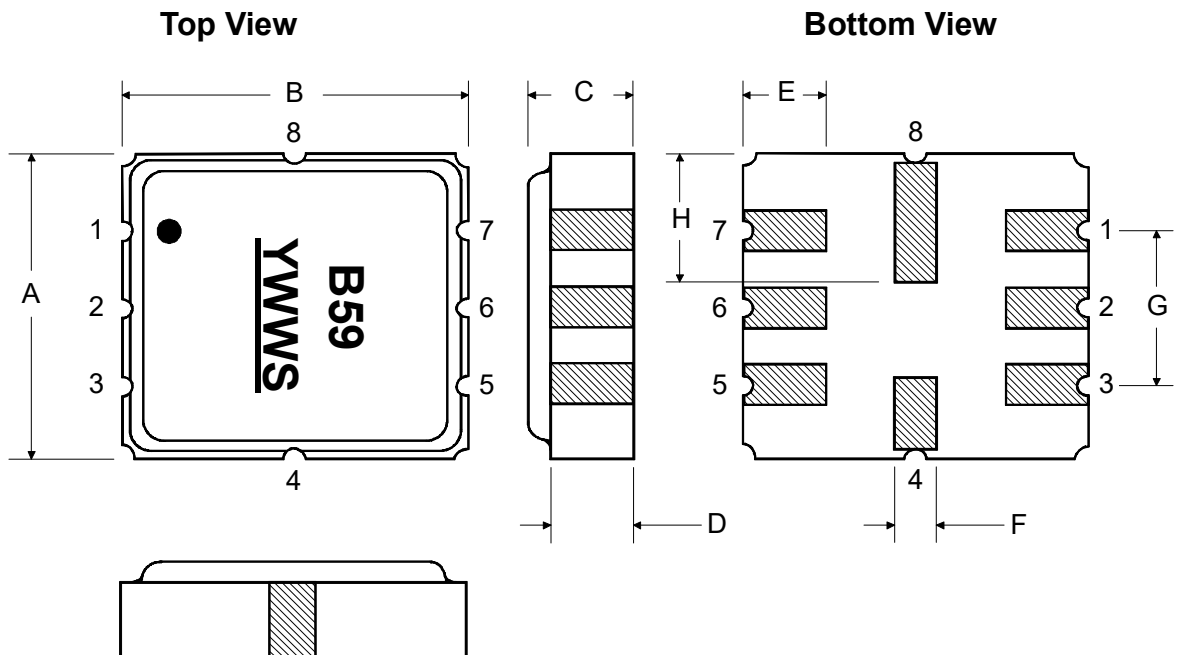

Tape and Reel Specifications

Tape and Reel Standard per ANSI/EIA-481

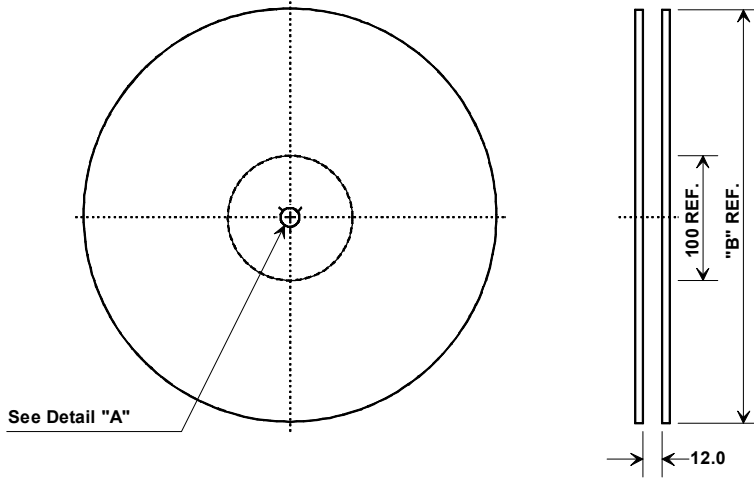

"B" Nominal Size		Quantity Per Reel
Inches	millimeters	
7	178	500
13	330	3000

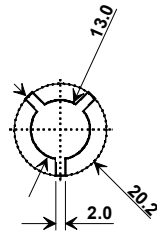

COMPONENT ORIENTATION and DIMENSIONS

Carrier Tape Dimensions	
Ao	4.25 mm
Bo	4.25 mm
Ko	1.3 mm
Pitch	8.0 mm
W	12.0 mm

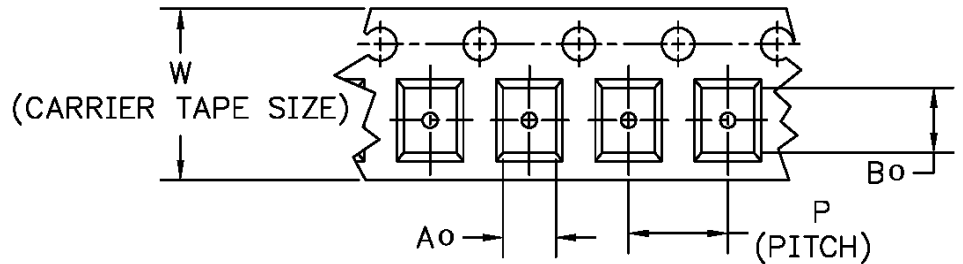
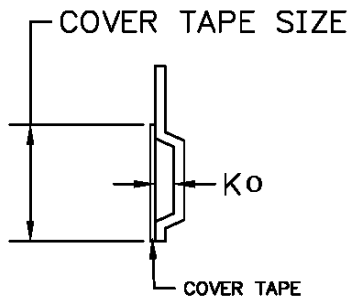

Recommended Reflow Profile

1. Preheating shall be fixed at 150~180°C for 60~90 seconds.
2. Ascending time to preheating temperature 150°C shall be 30 seconds min.
3. Heating shall be fixed at 220°C for 50~80 seconds and at 260°C +0/-5°C peak (10 seconds).
4. Time: 5 times maximum.

