

描述 / Descriptions

N 沟道 TO-252 塑封封装场效应管。N-CHANNEL MOSFET in a TO-252 Plastic Package.

特征 / Features

RDS(on) 小, 门电荷低, Crss 小, 开关速度快。无卤产品。

Low RDS(on), low gate charge, low Crss, fast switching. HF Product.

用途 / Applications

用于低压电路如: 汽车电路、DC/DC 转换、便携式产品的电源高效转换、TV/Monitor 电源板卡。

Suited for low voltage applications such as automotive, DC/DC Converters, high efficiency switching for power management in portable and battery operated products, and power management interface card for TV or Monitor.

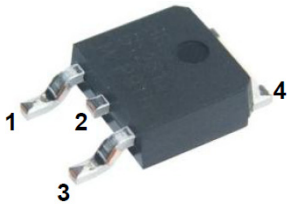
引脚排列 / Pinning

PIN1 : G

PIN 2 : D

PIN 3 : S

PIN 4 : D

放大及印章代码 / h_{FE} Classifications & Marking

见印章说明。See Marking Instructions.

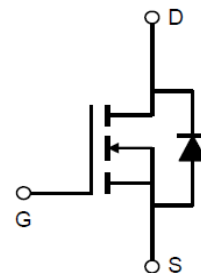
内部等效电路 / Equivalent Circuit

极限参数 / Absolute Maximum Ratings(Ta=25°C)

参数 Parameter		符号 Symbol	数值 Rating	单位 Unit
Drain-Source Voltage		V_{DS}	150	V
Gate-Source Voltage		V_{GS}	± 20	V
Continuous Drain Current	$T_C=25^\circ\text{C}$	I_D	10	A
Pulsed Drain Current ^C		I_{DM}	25	
Avalanche Current ^C		I_{AS}	10.8	A
Avalanche energy L=0.1 mH ^C		E_{AS}	7	mJ
Power Dissipation ^B	$T_C=25^\circ\text{C}$	P_D	54	W
Junction and Storage Temperature Range		T_J, T_{STG}	-55 to 150	$^\circ\text{C}$
Maximum Junction-to-Ambient ^A	$t \leq 10\text{s}$	$R_{\theta JA}$	44	$^\circ\text{C/W}$
Maximum Junction-to-Ambient ^{AD}	Steady-State		110	$^\circ\text{C/W}$
Maximum Junction-to-Case		$R_{\theta JC}$	2.8	$^\circ\text{C/W}$

电性能参数 / Electrical Characteristics(Ta=25°C)

参数 Parameter	符号 Symbol	测试条件 Test Conditions	最小值 Min	典型值 Typ	最大值 Max	单位 Unit
Drain-Source Breakdown Voltage	BV_{DSS}	$I_D=250\mu\text{A}, V_{GS}=0\text{V}$	150	155		V
Zero Gate Voltage Drain Current	I_{DSS}	$V_{DS}=150\text{V}, V_{GS}=0\text{V}$ $T_J=125^\circ\text{C}$			1	μA
					5	
Gate-Body leakage current	I_{GSS}	$V_{DS}=0\text{V}, V_{GS}=\pm 20\text{V}$			± 100	nA
Gate Threshold Voltage	$V_{GS(th)}$	$V_{DS}=V_{GS}, I_D=250\mu\text{A}$	1		3	V
Static Drain-Source On-Resistance	$R_{DS(ON)}$	$V_{GS}=10\text{V}, I_D=7\text{A}$		182	300	m Ω
		$V_{GS}=4.5\text{V}, I_D=6\text{A}$		183	450	
Diode Forward Voltage	V_{SD}	$I_S=1\text{A}, V_{GS}=0\text{V}$			1	V

电性能参数 / Electrical Characteristics(Ta=25°C)

参数 Parameter	符号 Symbol	测试条件 Test Conditions	最小值 Min	典型值 Typ	最大值 Max	单位 Unit
Input Capacitance	C_{iss}	$V_{GS}=0V, V_{DS}=25V,$ $f=1MHz$		660		pF
Output Capacitance	C_{oss}			74		
Reverse Transfer Capacitance	C_{rss}			17		
Gate resistance	R_g	$V_{GS}=0V, V_{DS}=0V,$ $f=1MHz$		2.6		Ω
Turn-On Delay Time	$t_{D(on)}$	$V_{GS}=10V, V_{DS}=75V,$ $I_D=5A,$ $R_L=14.7\ \Omega, R_{GEN}=50\ \Omega$			60	ns
Turn-On Rise Time	t_r				250	
Turn-Off Delay Time	$t_{D(off)}$				135	
Turn-Off Fall Time	t_f				135	
Body Diode Reverse Recovery Time	t_{rr}	$ISD=4A,$ $dI/dt=100A/ms$		200		ns

A. The value of $R_{\theta JA}$ is measured with the device mounted on 1in2 FR-4 board with 2oz. Copper, in a still air environment with $T_A = 25^\circ C$. The

Power dissipation P_{DSM} is based on $R_{\theta JA}$ and the maximum allowed junction temperature of $150^\circ C$. The value in any given application depends on the user's specific board design, and the maximum temperature of $150^\circ C$ may be used if the PCB allows it.

B. The power dissipation P_D is based on $T_{J(MAX)}=150^\circ C$, using junction-to-case thermal resistance, and is more useful in setting the upper dissipation limit for cases where additional heatsinking is used.

C. Repetitive rating, pulse width limited by junction temperature $T_{J(MAX)}=150^\circ C$. Ratings are based on low frequency and duty cycles to keep initial $T_J = 25^\circ C$.

D. The $R_{\theta JA}$ is the sum of the thermal impedance from junction to case $R_{\theta JC}$ and case to ambient.

电参数曲线图 / Electrical Characteristic Curve

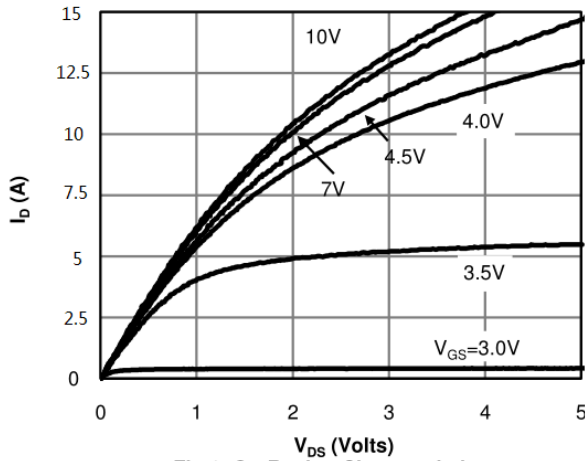

Fig 1: On-Region Characteristics

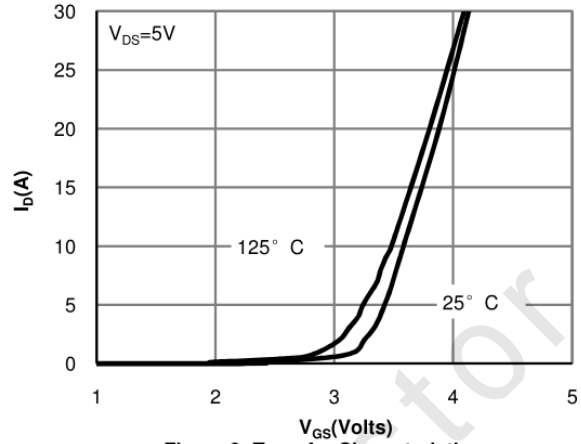

Figure 2: Transfer Characteristics

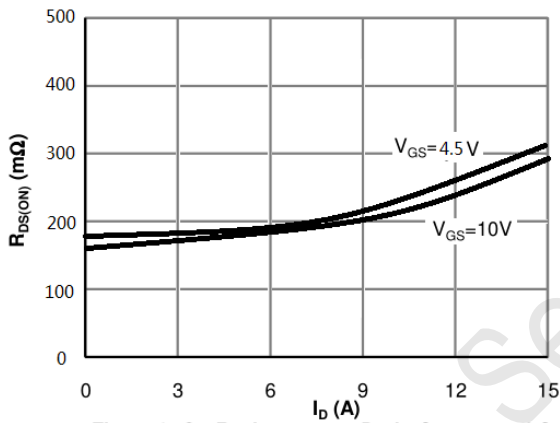

Figure 3: On-Resistance vs. Drain Current and Gate Voltage

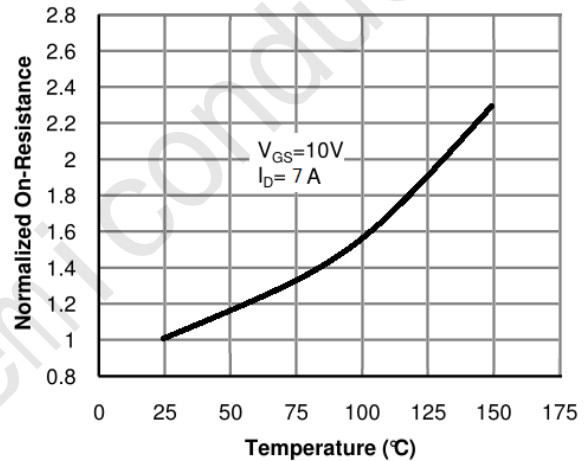

Figure 4: On-Resistance vs. Junction Temperature

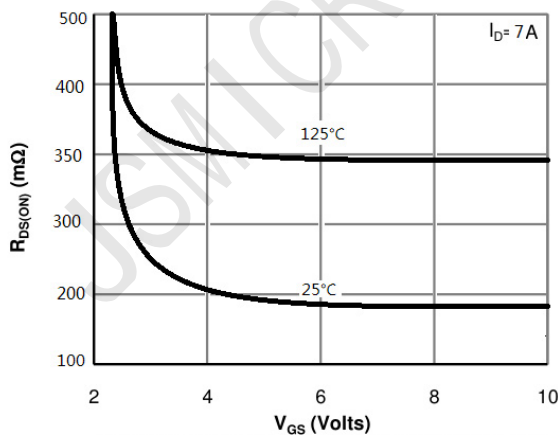

Figure 5: On-Resistance vs. Gate-Source Voltage

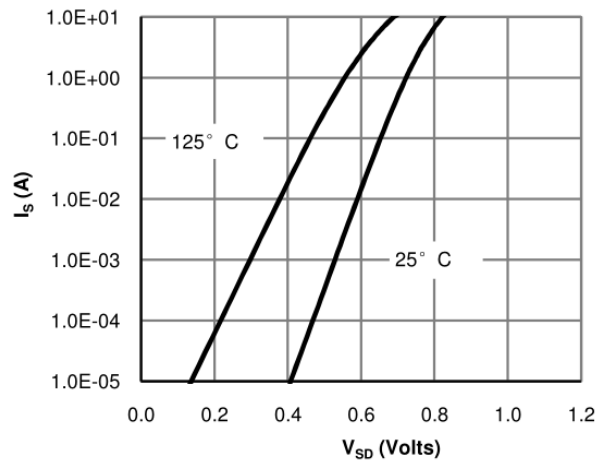

Figure 6: Body-Diode Characteristics

电参数曲线图 / Electrical Characteristic Curve

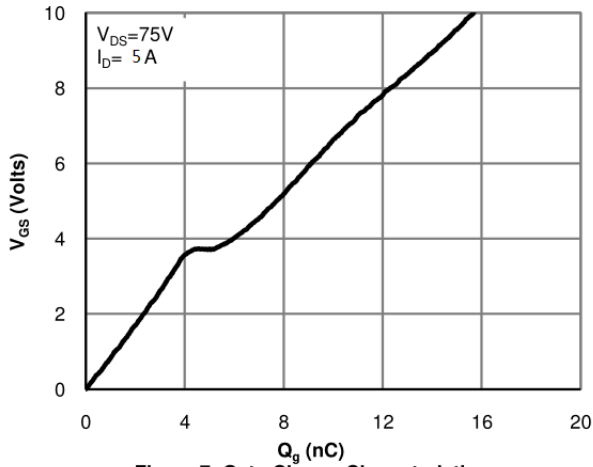

Figure 7: Gate-Charge Characteristics

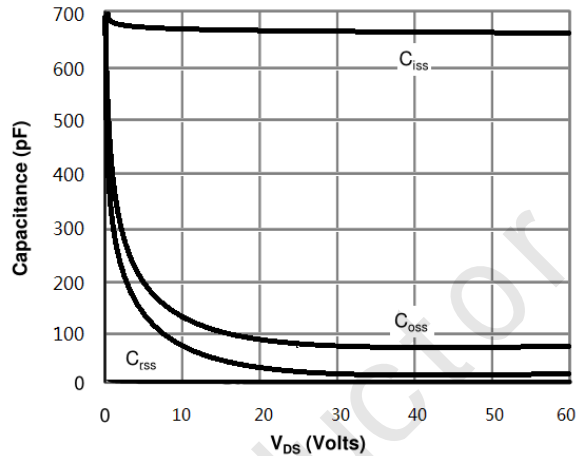

Figure 8: Capacitance Characteristics

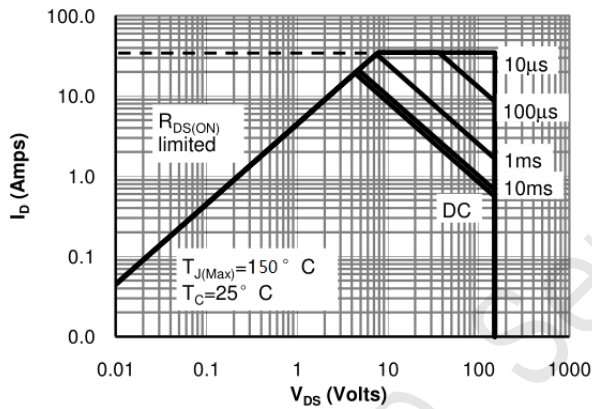

Figure 9: Maximum Forward Biased Safe Operating Area

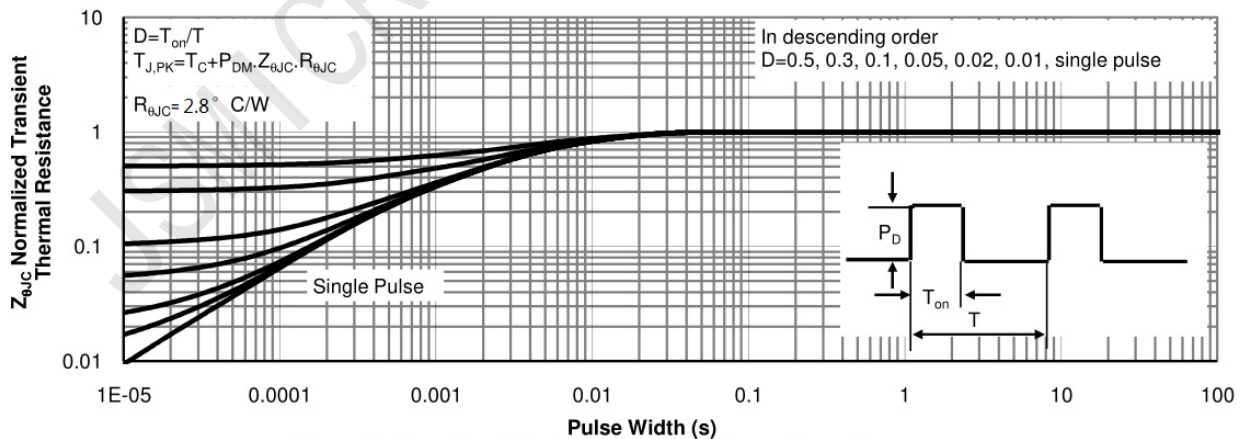
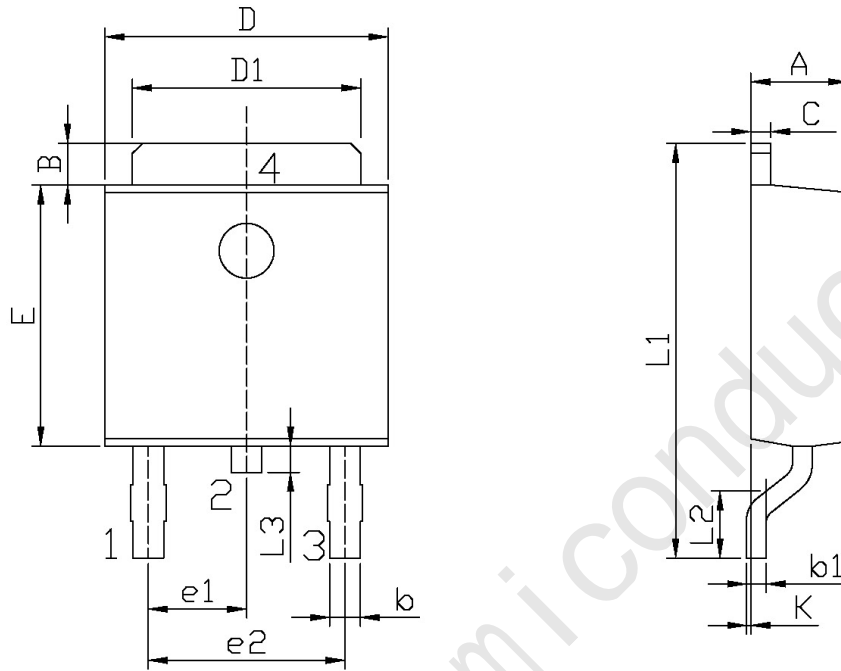

Figure 10: Normalized Maximum Transient Thermal Impedance

外形尺寸图 / Package Dimensions



单位: mm

Symbol	Dimensions In Millimeters		Symbol	Dimensions In Millimeters	
	Min	Max		Min	Max
A	2.20	2.40	E	5.95	6.25
B	0.95	1.25	e1	2.24	2.34
b	0.50	0.70	e2	4.43	4.73
b1	0.45	0.55	L1	9.45	9.95
C	0.45	0.55	L2	1.25	1.75
D	6.45	6.75	L3	0.60	0.90
D1	5.10	5.50	K	0.00	0.10

TO-252

印章说明 / Marking Instructions

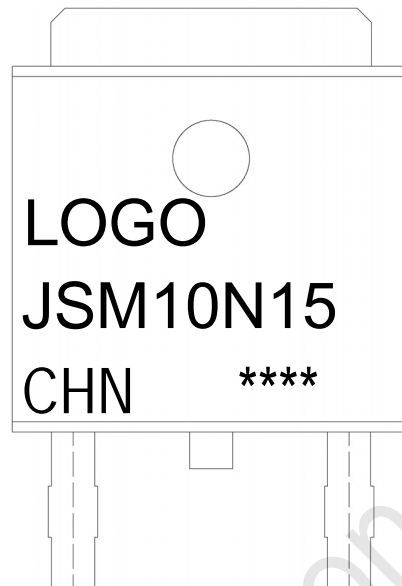

说明：

LOGO： 为公司图标

10N15 为型号代码

****： 为生产批号代码，随生产批号变化。

CHN: 中国产地

LOGO: Company Logo

10N15 : Product Type Code.

****: Lot No. Code, code change with Lot No.