

SMD Crystal Resonator 贴片石英晶体谐振器

5032 24.000MHz 12PF 40 Ω ±10PPM

1. Electrical characteristics 电气性能

Items 项目	Symbol 符号	Specification 规格说明			Unit 单位	Notes
		Min 最小	Typ 标准	Max 最大		
Model No 型号		Seam Seal 5032				
Blank Cutting Mode 晶片切型		AT FUND.				
Nominal Frequency 标称频率	FL	24.000000			MHz	
Oscillation Mode 振荡模式		■Fundamental □3rd				
Load Capacitance 负载电容	CL		12		pF	
Frequency Stability 频率公差		-10		10	ppm	
Operating Temperature 工作温度	Topr	-20		70	°C	
Storage Temperature 储存温度	Tstg	-40	~	85	°C	
Drive Level 驱动功率	DL		100		uW	
Effective Resistance RR 等效电阻	Rr	-	-	40	Ω	-
Shunt Capacitance C0 并联电容	C0	-	-	7	pF	-
Motional Capacitance C1 动态电容	C1	-	-	NA	fF	-
Insulation Resistance 绝缘电阻	Rins	500	-	-	MΩ	at DC 100V
Aging:老化率		-3		+3	ppm	Per year
Weight 重量			0.0425		g	

Remark备注: Sample Data See Attachment 抽样资料见附件

Measure equipment测量设备 :

Electrical characteristics measured by S&A 250B or equivalent.

电气性能测量为S&A 250B或相当设备。

Hermetically密封性 :

Fine Leak细漏: Helium Bombing 4kg/cm² for 1 Hour, Leak ate Less Than 1×10⁻⁸ atm. cc/sec
 氦气加压4kg/cm² 1小时, 氦质谱检漏仪检测泄漏小于 1×10⁻⁸ atm. cc/sec

Gross Leak精漏: 125°C FC#40, 120 Seconds, No Bubble
 放入125度氟油120秒不起泡

2. Solder Dimension And Pattern 焊接模型尺寸图:

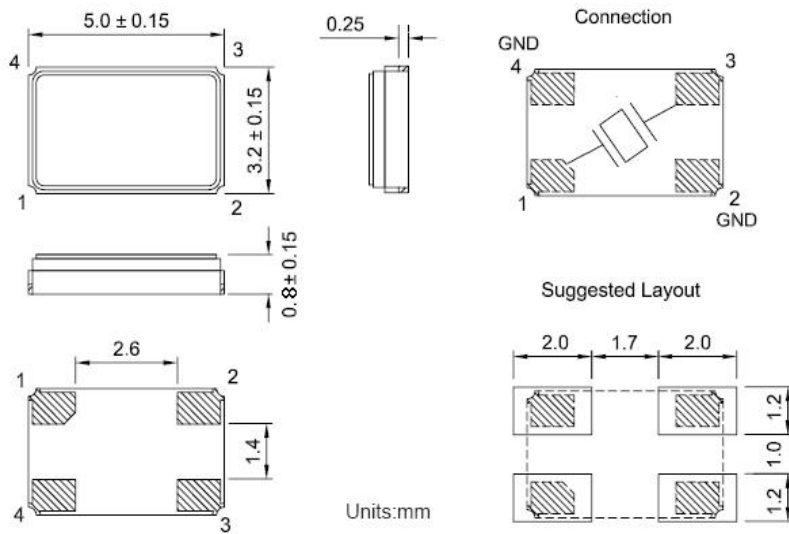

3. Equivalent Circuit 等效电路图:

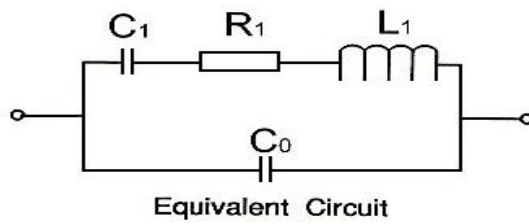

4. Structure drawing 结构图:

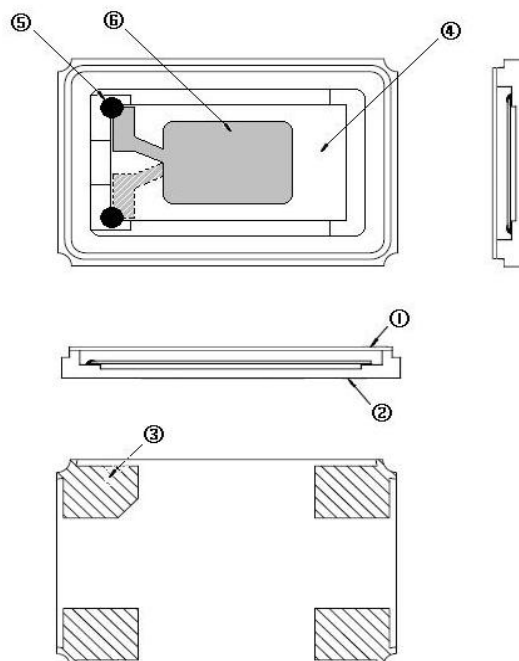

NO	COMPONENTS 构成	MATERIALS 原料	QTY 数量	FINISH / SPECIFICATIONS 结束/说明
1	Cap上盖	Metal (Fe) 金属	1	-
2	Base基座	Ceramic陶瓷制品	1	Color black炭黑色
3	PAD焊盘	Au金	4	Tungsten metalize钨合金 + Ni plating镍电镀 + Au plating金电镀
4	Crystal Blank石英晶片	SiO ₂ 二氧化硅	1	-
5	Conductive Adhesive 导电粘合剂	Ag银	4	Silicone硅树脂
6	Electrode电极	Ag银 + Cr铬	2	-

5. Reliability Specification 可靠性说明

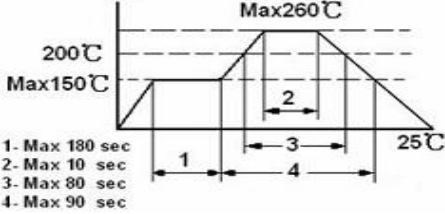
Item 项目	Condition 条件	Standard 标准
1. Drop characteristics 跌落特性	Free drop from 75cm height on a hard wooden board for 3 times. (Board is thickness more than 30 mm.)	Frequency change: $\leq \pm 5\text{ppm}$ Rr as specification
2. Mechanical shock 机械冲击	Device are shocked to half sine wave (1000g) three mutually perpendicular axes each 3 times	Frequency change: $\leq \pm 5\text{ppm}$ Rr as specification
3. Shake characteristics 震动特性	Shake frequency 10~55Hz, cycl~2 minutes, swing 1.5mm, direction x/y/z, all 30 minutes, test after 1 hours.	Frequency change: $\leq \pm 5\text{ppm}$ Rr as specification
4. Humidity characteristics 湿度特性	+40 \pm 2 $^{\circ}\text{C}$ & 90%~95% R.H. 250 hours	Frequency change: $\leq \pm 5\text{ppm}$ Rr as specification
5. Low temperature characteristics 低温特性	-40 \pm 2 $^{\circ}\text{C}$, 250 hours, put in room temperature, test after 1 hours.	Frequency change: $\leq \pm 5\text{ppm}$ Rr as specification
6. High temperature characteristics 高温特性	+85 \pm 2 $^{\circ}\text{C}$, 250 hours, put in room temperature, test after 1 hours.	Frequency change: $\leq \pm 5\text{ppm}$ Rr as specification
7. Temperature cycling 温度循环	-30 \pm 3 $^{\circ}\text{C}$ /30 \pm 3 min~+85 \pm 2 $^{\circ}\text{C}$ /30 \pm 3min, 5 cycles	Frequency change: $\leq \pm 5\text{ppm}$ Rr as specification
8. Refluence examination 回流焊特性		Frequency change: $\leq \pm 5\text{ppm}$ Rr as specification

6. Type & Reel 编带类型及卷盘

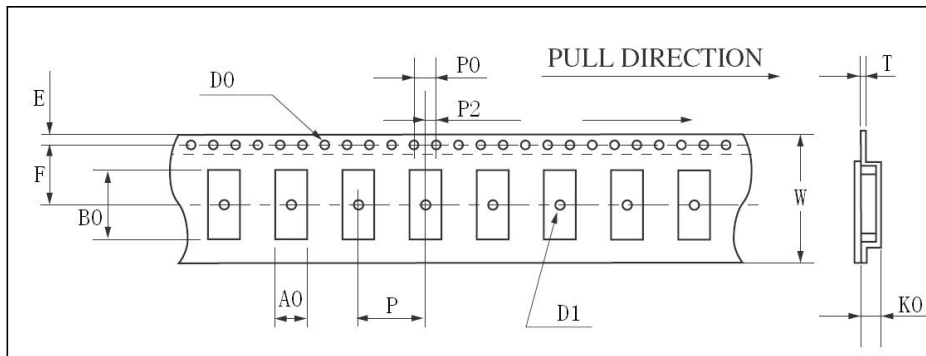

	HC-49SMD	5032	3225	2520
W	24.00±0.30	12.00±0.05	8.00±0.05	8.00±0.05
E	1.75±0.10	1.75±0.10	1.75±0.05	1.75±0.05
F	11.5±0.10	5.5±0.10	3.5±0.05	3.5±0.05
T	0.40±0.05	0.30±0.05	0.25±0.03	0.25±0.03
P	12.00±0.10	8.00±0.10	4.00±0.05	4.00±0.05
P0	4.00±0.10	4.00±0.10	4.00±0.05	4.00±0.05
P2	2.00±0.10	2.00±0.10	2.00±0.05	2.00±0.05
D0	φ 1.50+0.10	φ 1.50+0.10	φ 1.50+0.10	φ 1.50+0.10
D1	φ 1.50MIN	φ 1.50MIN	φ 1.00MIN	φ 1.00MIN
A0	4.60±0.10	3.50±0.10	2.70±0.05	2.25±0.05
K0	4.40±0.10	1.60±0.10	1.50±0.10	0.70±0.10
B0	14.20±0.15	5.20±0.10	3.50±0.05	2.75±0.05