

Specification

- Part No. : **LBP.2450.X.A.30**
- Description : LTCC Band Pass Filter for 2450MHz
Bandwidth 100MHz
- Features : Center Frequency 2450 MHz
Low Insertion Loss
High Attenuation
Ultra-Compact, Low Profile SMT Package
Dims: 1.6 x 0.8 x 0.6mm



1. Introduction

Taoglas are utilizing their deep understanding of the RF component design and manufacturing process to provide high-quality, small-form-factor, cost-effective and easy to implement RF filters. The Taoglas Filters Division will feature a range of off-the-shelf filters for a variety of applications, including filters for emerging license free bands used for IoT and for GPS L1/L2 and L1/L5 applications. We can also work with customers to develop bespoke filter solutions.

Taoglas LTCC filters are designed to be used in wireless transmitters or receivers. They feature low insertion loss and provide good rejection of unwanted signals at harmonic frequencies for improved system performance. The product is manufactured as a multi-layer monolithic ceramic structure which provides high reliability in a lightweight, low-profile, industrial standard SMT package.

These small part sizes allow for high density PCB layout, provide excellent solderability, and allow for easy visual inspection capability.

The LBP.2450.X.A.30 is a standard Taoglas product but can be customized for specific customer needs. For more information please contact your regional sales office.

2. Specification

Electrical	
Centre Frequency (Fo)	2450 MHz
3dB Bandwidth	100 MHz
Insertion Loss	2.2 dB max
Return Loss	< -10 dB
Attenuation	> 30dB @ 0 ~ 1785 MHz > 25dB @ 1785 MHz ~ 1910 MHz > 25dB @ 4800 MHz ~ 5000 MHz > 15dB @ 5000 MHz ~ 8000 MHz
In/Out Impedance	50 Ω
Power Dissipation	1.0 W min.
Mechanical	
Dimension	1.6 x 0.8 x 0.6mm (L x W x H)
Material	Ceramic
Finish	Ag plated
Environmental	
Operating Temperature	-40°C to 85°C
Storage Temperature	-40°C to 85°C

3. Characteristics Curve

3.1. Pass Band Return & Insertion Loss

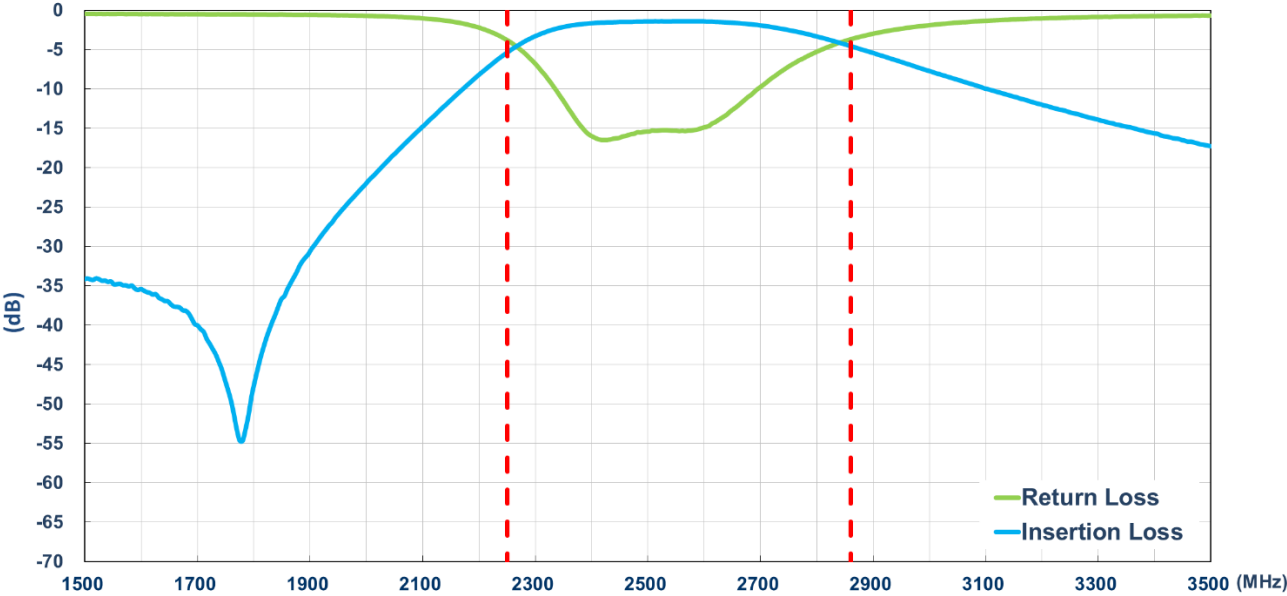

3.2. Out-Of-Band Attenuation

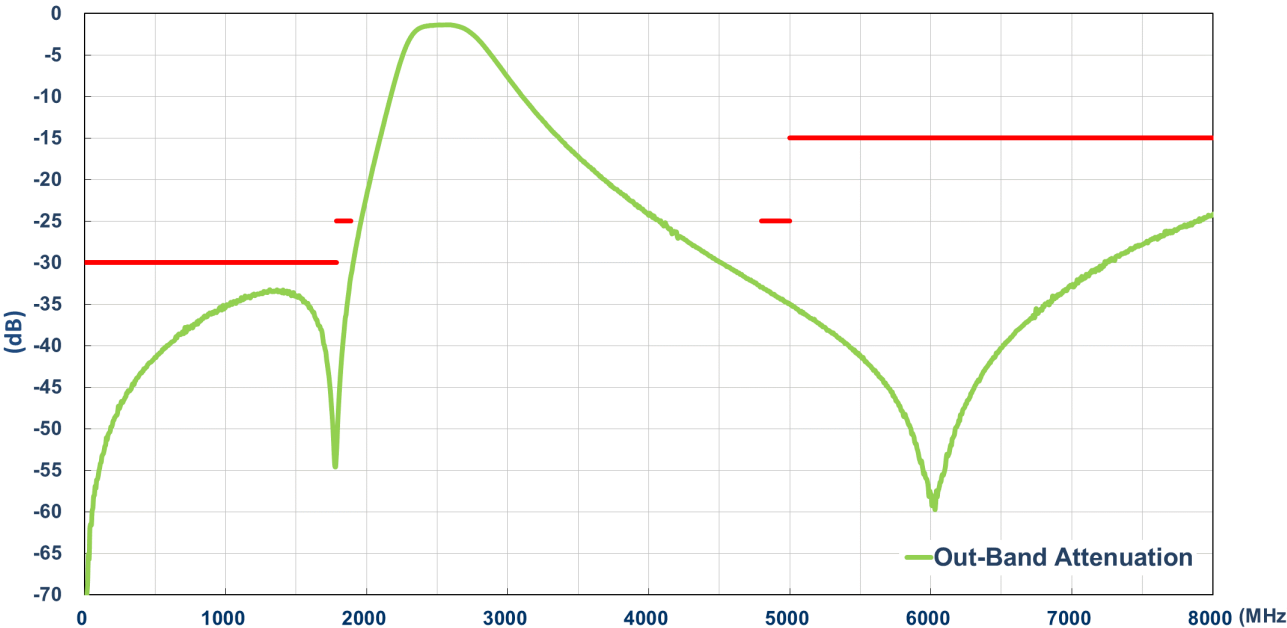

4. Mechanical Drawings (Unit: mm)

4.1. Antenna Drawing

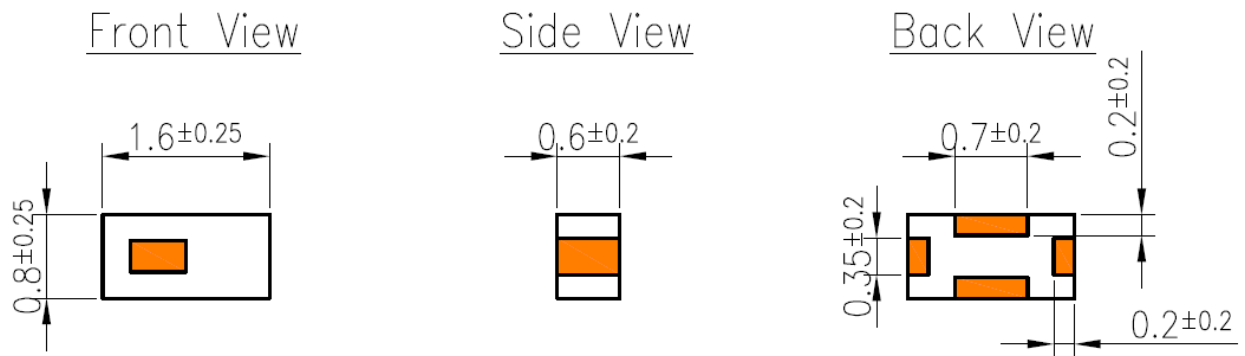





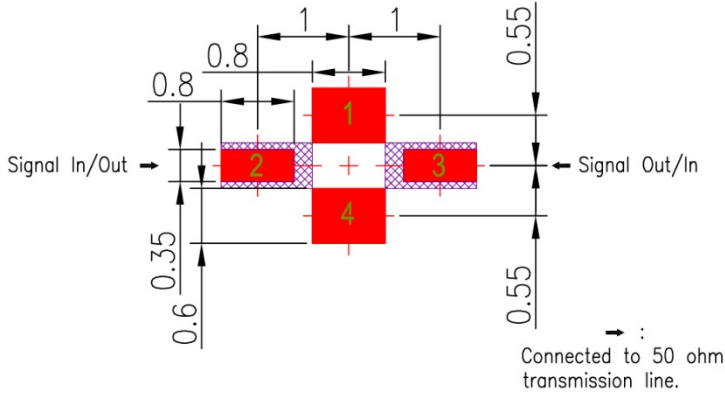

4.2. Recommended PCB Layout

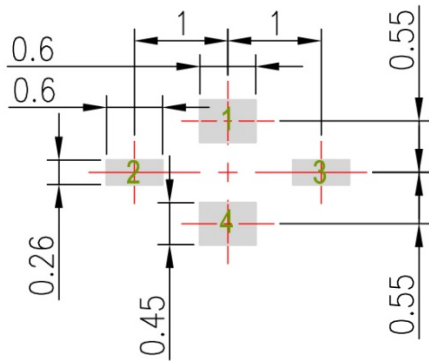
4.2.1. Top Copper



4.2.2. Top Solder Paste



- NOTE:
- 1. Ag Plated area 
 - 2. Solder Mask area 
 - 3. Copper area 
 - 4. Paste area 
 - 5. Copper Keepout Area 



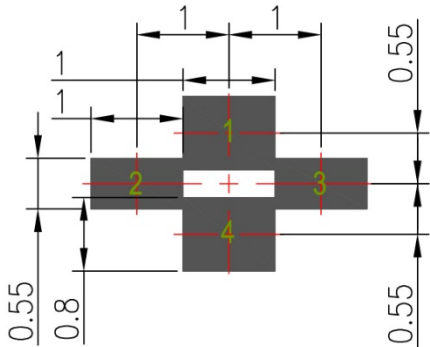

- 6. Any vias in pads should be either filled or tented to prevent solder from wicking away from the pad during reflow.
- 7. The dimension tolerances should follow standard PCB manufacturing guidelines

4.2.3. Top Solder Mask

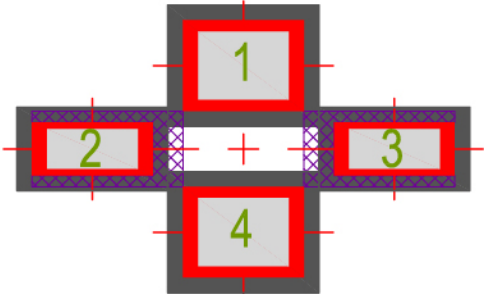

4.2.4. Top Solder Paste



- NOTE:
- 1. Ag Plated area 
 - 2. Solder Mask area 
 - 3. Copper area 
 - 4. Paste area 
 - 5. Copper Keepout Area 

- 6. Any vias in pads should be either filled or tented to prevent solder from wicking away from the pad during reflow.
- 7. The dimension tolerances should follow standard PCB manufacturing guidelines

4.3. Evaluation Board

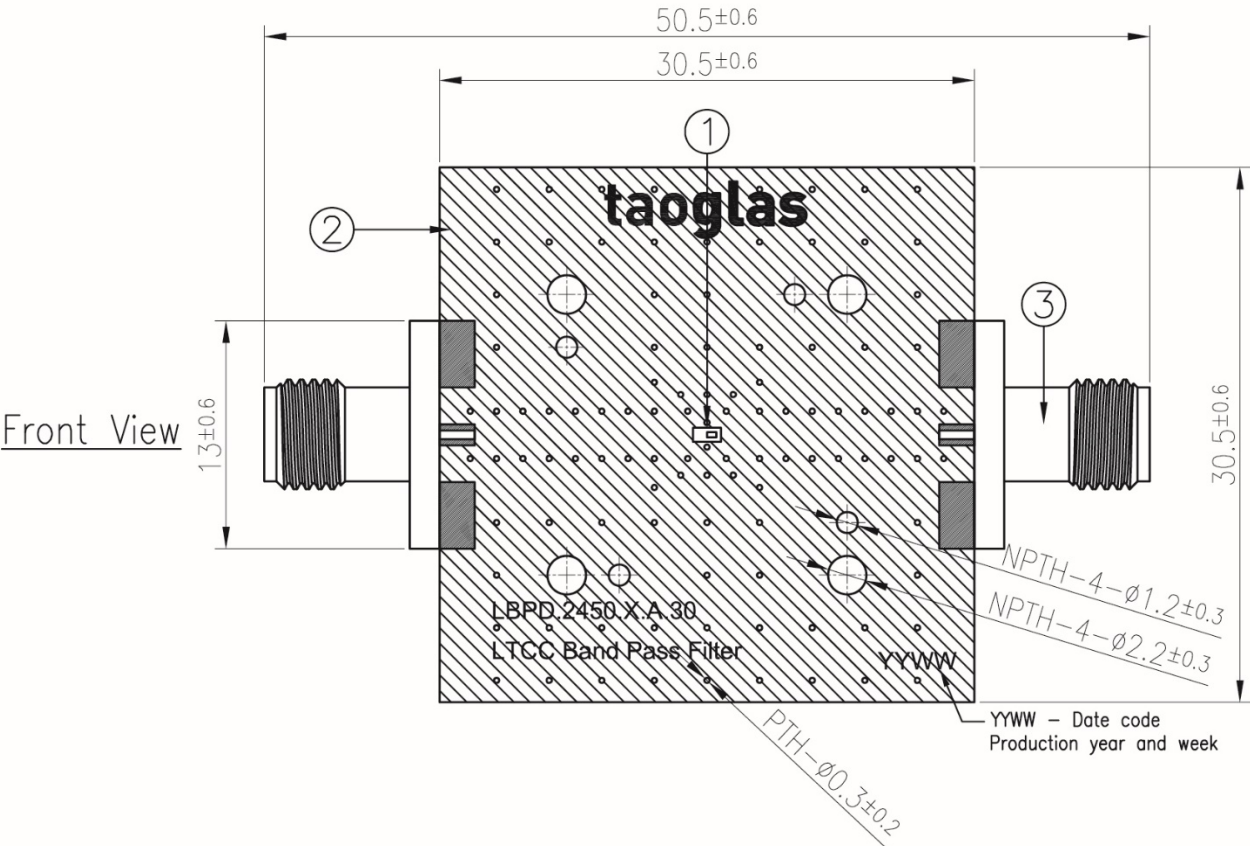

	Name	Material	Finish	QTY
1	Filter (1.6x0.8x0.6mm)	Ceramic	Clear	1
2	PCB	Composite 1.0t	Black	1
3	SMA(F) ST	Brass	Au Plated	2

5. Recommended Reflow Soldering Profile

Phase	Profile Features	Maximum
Preheat	Temperature Min	150 °C
	Temperature Max	180 °C
	Duration	60-120 sec
Ramp-Up	Avg. Ramp up rate	3 °C/sec (max)
Reflow	Temperature	220 °C
	Duration	30-40 sec
Peak	Temperature	265 °C
	Duration	5 sec Max
Ramp Down	Avg. Ramp down rate	3 °C/sec (max)

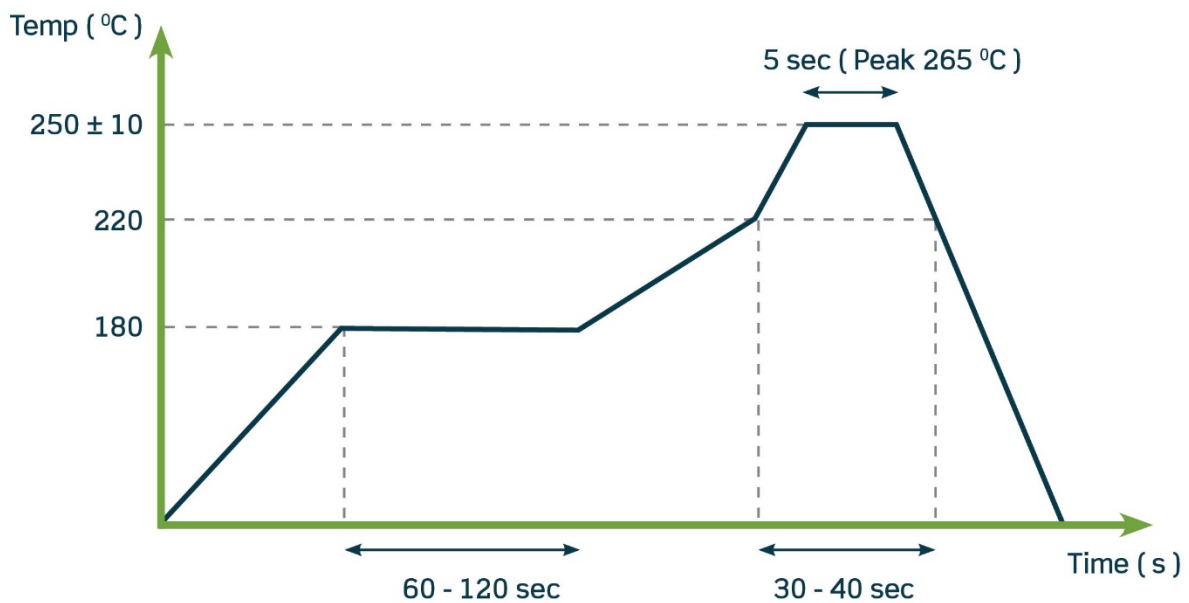

6. Packaging

6000 pc LLP.2450.X.A.30
 1 reel per small inner box
 Dimensions - 178*8.5mm
 Weight - 185g

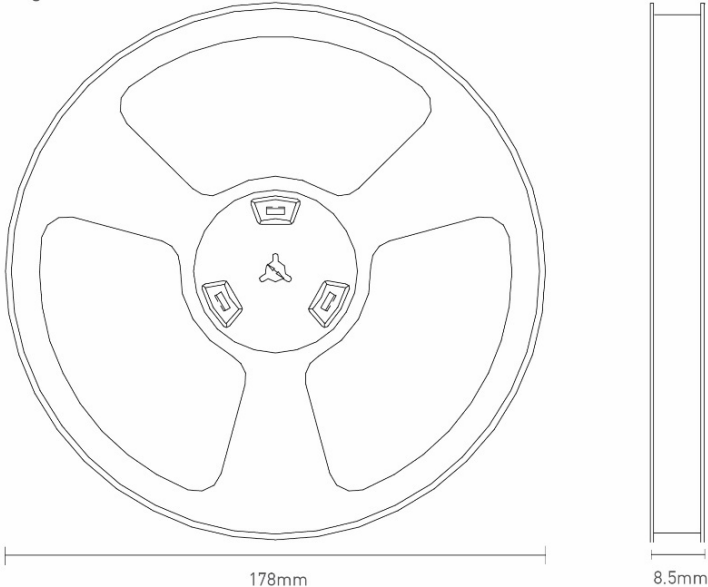

12000 pc LLP.2450.X.A.30
 2 reel in small inner box
 Dimensions - 190*190*28mm
 Weight - 0.42Kg

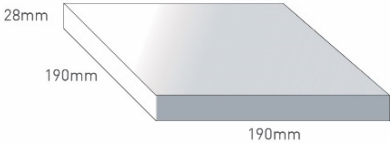

10 inner boxes / 120000 pcs in one carton
 Carton Dimensions - 330*210*210mm
 Weight - 4.5 Kg

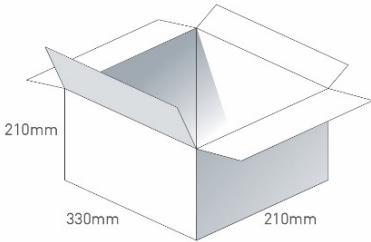

Taoglas makes no warranties based on the accuracy or completeness of the contents of this document and reserves the right to make changes to specifications and product descriptions at any time without notice. Taoglas reserves all rights to this document and the information contained herein.

Reproduction, use or disclosure to third parties without express permission is strictly prohibited.

Copyright © Taoglas Ltd.